

Electronics Dictionary

Electronics Dictionary

An illustrated glossary of over 6,000 terms used in radio, television, industrial electronics, communications, facsimile, sound recording, etc.

by NELSON M. COOKE

Lieutenant Commander, United States Navy (Retired);

President, Cooke Engineering Company;

Senior Member, Institute of Radio Engineers

and

JOHN MARKUS

Associate Editor, Electronics

McGRAW-HILL BOOK COMPANY, INC.

NEW YORK

1945

LONDON

IIA LIB

ELECTRONICS DICTIONARY

COPYRIGHT, 1945, BY THE
MCGRAW-HILL BOOK COMPANY, INC.

PRINTED IN THE UNITED STATES OF AMERICA

*All rights reserved. This book, or
parts thereof, may not be reproduced
in any form without permission of
the publishers.*

*The opinions or assertions contained herein
are not to be construed as official or
reflecting the views of the Navy Depart-
ment or of the naval service at large.*

Preface

The broad field of electronics embraces that branch of science which concerns itself with the conduction of electricity through gases or in a vacuum. The practical applications include radio communications, long-distance telephone and telegraph facilities, television, radar, facsimile, industrial control, and a host of other military, industrial, and communications applications. The majority of these are highly technical in nature; furthermore, the field is expanding rapidly. The vocabulary, therefore, contains thousands of terms, many of which are not contained even in the latest unabridged dictionaries.

The goal of the authors was to present the language of electronics in such a manner that the definitions would be of value to those who need an electronics dictionary—the engineers who must develop applications for electronic equipment, those who must use and maintain such equipment, and, particularly, the beginners who are interested in learning about electronics.

Although the book is written primarily at the level of a student who is learning fundamental electronic principles, every effort has been made to define the terms with the accuracy and carefulness demanded by the engineer. At the same time, most of the definitions will have useful meanings to nontechnical readers because each definition has been made as complete as possible in a technical work of this nature. However, it must be realized that electronics, in common with other branches of science, has levels in which terms are used that cannot be adequately defined except in highly technical terminology.

The rapid growth of electronics during the recent war years has resulted in groups of engineers employing different colloquialisms for the same terms. If favored terminology of any group is missing or incorrectly defined, the authors will appreciate recommendations for the inclusion of these terms in subsequent printings or editions.

Throughout the preparation of this book, abbreviations were a particularly trying problem. Only a few have as yet been standardized by the American Standards Association, and for the others many different forms are to be seen in technical books, periodicals, and even in the publications of different engineering societies.

The authors have endeavored to set up a complete and consistent abbreviating policy for electronic terms, based upon the groundwork laid

by American Standards Association and extended therefrom by adopting the precept that a given term is to have only one abbreviation regardless of grammatical usage. The average engineer or engineering student is a busy person and cannot, for instance, take time to figure out which of seven possible abbreviations—ac, a-c, a.c., AC, A-C, A.C., or A/C—he should use in the expression, “The line voltage is 115 volts a-c.”

Those readers who like a simplified one-abbreviation-per-term policy can adopt this book in toto as a one-volume style guide for both engineering and stenographic use, while others can quickly change controversial forms to their own style.

Another problem encountered is exemplified by the word pushbutton, alternatively spelled push-button or push button. A serious attempt was made to standardize the spelling of compound terms like this insofar as possible, giving consideration to common usage, future trends, and grammatical rules as well as to the style in the latest Merriam-Webster unabridged dictionary.

In the end, it is personal preference and opinion that govern style in technical terminology. This was well expressed by President Andrew Jackson, who, on being twitted one day about the inconsistency of his spelling, is said to have replied, “Well, sir, it is a damned poor mind that cannot think of more than one way to spell a word.”

NELSON M. COOKE,
JOHN MARKUS.

NEW YORK,
August, 1945.

Acknowledgments

The presentation of the language of electronics in a book of this nature would have been impossible without the help of a great many organizations and individuals.

The authors gratefully acknowledge the cooperation of the many manufacturers who sent complete sets of catalogues and technical literature for guidance in determining current usage of electronic terms.

The collections of definitions prepared by various engineering societies proved invaluable as references in phrasing many of the definitions in this book. These societies include The Institute of Radio Engineers, American Institute of Electrical Engineers, American Standards Association, The Institution of Electrical Engineers (Great Britain), and British Standards Institution.

To the staff of the Warrant Officers Radio Engineering School, a department of the Radio Matériel School, Naval Research Laboratory, sincere appreciation is expressed for careful checking of page proofs and for adding many additional terms and definitions.

The authors are greatly indebted to their wives for assistance in preparing the manuscript and for constant encouragement during the years of work on this book.

Particular thanks are extended to National Radio Institute, Washington, D.C., for granting permission to use many of the illustrations from their home-study radio textbooks and for lending original drawings.

The cooperation of the following manufacturers in furnishing illustrations and electros of their products for this book is also acknowledged:

Aerovox Corporation, New Bedford, Mass.

Allied Radio Corporation, Chicago, Ill.

American Radio Hardware Co., Inc., Mount Vernon, N.Y.

American Telephone and Telegraph Company, New York, N.Y.

Audio Devices Inc., New York, N.Y.

Automatic Electric Co., Chicago, Ill.

Bendix Radio Division, Bendix Aviation Corp., Baltimore, Md.

Bradley Laboratories, Inc., New Haven, Conn.

Bud Radio, Inc., Cleveland, Ohio

Carron Manufacturing Co., Chicago, Ill.

Central Scientific Co., Chicago, Ill.

Centralab Manufacturing Co., Chicago, Ill.

Chisholm-Ryder Co., Inc., Premax Products Div., Niagara Falls, N.Y.

Consolidated Wire and Associated Companies, Chicago, Ill.

Cornell-Dubilier Electric Corp., South Plainfield, N.J.
 Fisher Research Laboratory, Palo Alto, Calif.
 Galvin Manufacturing Corp., Chicago, Ill.
 General Electric Co., Schenectady, N.Y.
 General Scientific Corp., Chicago, Ill.
 Gothard Manufacturing Co., Springfield, Ill.
 The Indiana Steel Products Co., Chicago, Ill.
 International Telephone & Telegraph Co., New York, N.Y.
 JFD Manufacturing Co., Brooklyn, N.Y.
 Keuffel & Esser Co., Hoboken, N.J.
 Lapp Insulator Co., Inc., LeRoy, N.Y.
 P. R. Mallory & Co., Inc., Indianapolis, Ind.
 Meissner Manufacturing Co., Mt. Carmel, Ill.
 The Mercoid Corp., Chicago, Ill.
 Metals and Alloys, New York, N.Y.
 Mueller Electric Co., Cleveland, Ohio
 National Broadcasting Co., Inc., New York, N.Y.
 National Union Radio Corporation, Newark, N.J.
 The New Jersey Zinc Company, New York, N.Y.
 Philco Corporation, Philadelphia, Pa.
 The Progressive Mfg. Co., Torrington, Conn.
 Radio Magazines, Inc., New York, N.Y.
 Radio Corporation of America, RCA Victor Division, Camden, N.J.
 Radio News, Chicago, Ill.
 Radolek Company, Chicago, Ill.
 Scientific American, New York, N.Y.
 Sperry Gyroscope Co., Inc., Brooklyn, N.Y.
 Sylvania Electric Products Inc., Emporium, Pa.
 Tinnerman Products, Inc., Cleveland, Ohio
 Tung-Sol Lamp Works Inc., Newark, N.J.
 University of Illinois, College of Engineering, Urbana, Ill.
 Utah Radio Products Co., Chicago, Ill.
 The Vibroplex Co., Inc., New York, N.Y.
 Western Electric Co., Inc., New York, N.Y.
 Westinghouse Electric Corporation, East Pittsburgh, Pa.
 Wheelco Instruments Co., Chicago, Ill.
 Wincharger Corporation, Sioux City, Iowa
 World Broadcasting System, Inc., New York, N.Y.

Thanks are also extended to the authors of the following books for permission to reproduce diagrams from their works:

A. L. Albert, "Fundamentals of Telephony."
 W. D. Cockrell, "Industrial Electronic Control."
 G. L. Clark, "Applied X-rays."
 D. G. Fink, "Principles of Television Engineering."
 L. R. Lohr, "Television Broadcasting."

ELECTRONICS DICTIONARY

A

- A** 1. Abbreviation for angstrom unit, which is a unit of length, equal to 10^{-8} centimeter, and is used in expressing wavelengths of light. 2. Chemical symbol for argon, an inert gas used in various electronic tubes.
- A+** (A plus, or A positive) The positive terminal of an A battery or positive polarity of other sources of filament voltage. On electronic equipment, other than sources of filament voltage, A+ denotes the terminal to which the positive side of the filament voltage source is to be connected. (F+ is synonymous.)
- A-** (A minus, or A negative) The negative terminal of an A battery or negative polarity of other sources of filament voltage. On electronic equipment, other than sources of filament voltage, A- denotes the terminal to which the negative side of the filament voltage source should be connected. (F- is synonymous.)
- abampere** The centimeter-gram-second electromagnetic unit of current. One abampere is equal to 10 amperes.
- A battery** Any battery that supplies the power for filaments of vacuum tubes.
- abc** Abbreviation for automatic bass compensation, a circuit used in some receivers in an effort to make bass notes sound more natural at low volume-control settings.
- abcoulomb** The centimeter-gram-second electromagnetic unit of quantity of electricity. An abcoulomb of electricity is the quantity that passes a point in an electric circuit in one second when the current is 1 abampere. One abcoulomb is equal to 10 coulombs.
- aberration** Any defect in an optical image. Aberration is produced by the failure of a lens or mirror to bring all light rays to the same focus.
- abfarad** The centimeter-gram-second electromagnetic unit of capacitance. A capacitor, or circuit, has a capacitance of one abfarad when a charge of one abcoulomb produces a difference of potential of one abvolt between the terminals. One abfarad is equal to 10^9 (one billion) farads.
- abhenry** The centimeter-gram-second electromagnetic unit of inductance. An inductor, or circuit, has an inductance of one abhenry when an electromotive force (difference of potential) of one abvolt is induced across its terminals by a current changing at the rate of one abampere per second. One abhenry is equal to 10^{-9} (one-billionth) henry.
- abmho** The centimeter-gram-second electromagnetic unit of conductance. A conductor, or circuit, has a conductance of one abmho when a difference of potential of one abvolt between its terminals will cause a current of one abampere to flow through the conductor. One abmho is equal to 10^{-9} (one-billionth) mho.
- abnormal reflections** Sharply defined reflections of radio waves from an ionized layer of the ionosphere, occurring at frequencies greater than the critical frequency or penetration frequency of the layer. Also called *sporadic reflections*.
- abohm** The centimeter-gram-second electromagnetic unit of resistance. A conductor, or circuit, has a resistance of one abohm when a difference of potential of one abvolt across its

AB POWER PACK

terminals will cause a current of one abampere to flow. One abohm is equal to 10^{-9} (one-billionth) ohm.

AB power pack A complete power source for battery-operated vacuum-tube circuits. Such a power pack consists of suitable batteries assembled as a single unit, or a separate unit that comprises an alternating-current-operated source of power.

abrasive Hard pulverized materials sometimes incorporated in phonograph records. The abrasive material is used to shape the point of the phonograph needle to conform with the groove in the record.

abs Sometimes used as abbreviation for absolute.

abscissa The horizontal distance from a point on a graph to the vertical reference line. The units of this distance are indicated on a scale at the bottom of the graph.

absolute An adjective used in connection with scientific units such as ampere, coulomb, henry, mho, ohm, volt, joule, and watt. An absolute system of units is one in which a small number of units are chosen as fundamental and all other units are derived from them. *Example:* The absolute ampere (abampere) is an absolute unit of current, while the ampere is a derived unit of current.

absolute efficiency The ratio of the power output of an electroacoustic transducer under specified conditions to the power output of the ideal electroacoustic transducer.

absolute humidity The mass of water vapor per unit volume in the atmosphere at a given temperature; that is, the amount of water vapor present in a given volume of air.

absolute system A system of units in which a small number of units are chosen as fundamental and all other units are derived from them. *Example:* The absolute ohm (abohm) is an absolute unit of resistance, while the ohm is a derived unit.

absolute temperature Temperature measured by means of a scale having its zero marked at absolute zero temperature, the lowest possible temperature. With the exception of the zero marking, the absolute scale has the same calibration as the centigrade scale. To obtain absolute temperature, add 273.1° to the centigrade value. The absolute scale is sometimes called the *Kelvin scale*, and absolute temperatures are often expressed as so many degrees Kelvin.

absolute value The numerical value of a number without regard to sign. Thus, 7 is the absolute value of both $+7$ and -7 . Vertical lines on each side of a quantity or symbol specify that its absolute value is intended. Thus, the absolute value of Z is written $|Z|$.

absolute zero The lowest possible temperature that can exist, corresponding to a complete absence of molecular motion. Absolute zero is approximately -273.1° centigrade, or -459.8° Fahrenheit.

absorption The dissipation of energy in traveling through a medium. *Examples:* Electromagnetic energy is lost when radio waves travel through space. Acoustic energy is lost when sound waves travel through the atmosphere or any other medium.

absorption coefficient 1. A measure of the sound-absorbing characteristics of a material. 2. The ratio of the linear rate of change of intensity of X rays in a given uniform material to the intensity at a given point.

absorption current A component of dielectric current which, in an imperfect dielectric, is proportional to the rate of accumulation of electric charges within the dielectric.

absorption modulation Modulation produced in radio transmission by varying the radiation resistance of the transmitting antenna in accordance with the intelligence to be transmitted, thereby varying the power radiated by the antenna. Absorption modulation may be accomplished directly

A-C GENERATOR

with a microphone or by means of vacuum-tube circuits. Such systems of modulation are seldom used with modern radio transmitters.

absorption spectrum Dark lines or gaps in a spectrum which are due to the absorption of certain rays by gas, a solution, or other absorbing material.

absorption wavemeter An instrument for measuring wavelength by tuning a resonant circuit until it absorbs maximum energy from the source whose wavelength is being measured.

abvolt The centimeter-gram-second electromagnetic unit of potential difference. A difference of potential of one abvolt exists between two points when one erg of work is required to transfer one abcoulomb of positive electricity from the point of lower potential to the point of higher potential. One abvolt is equal to 10^{-8} volt.

a-c Abbreviation for alternating current. Same abbreviation used for noun and adjective.

accelerating anode See *accelerating electrode*.

accelerating electrode 1. An electrode used in cathode-ray tubes and other electronic tubes to increase the velocity of the electrons in a beam. Such an electrode is operated at a high positive potential with respect to the cathode. 2. An electrode used for drawing electrons away from a light-sensitive cathode of a Farnsworth image dissector tube for a television camera.

acceleration The rate at which the velocity of a body changes.

acceleration voltage The voltage between the cathode and anode in a velocity-modulation tube. This voltage determines the average velocity of the electrons in the beam. Also called *beam voltage*.

accent A mark sometimes used to distinguish similar symbols representing different quantities or conditions. A single accent is read "prime"; a double accent is read "double prime."

*Examples: R' is read "R prime."
R'' is read "R double prime."*

accentuation 1. Emphasizing a certain band of frequencies in an audio-frequency amplifier. 2. The method of placing emphasis on the higher audio frequencies in the audio-frequency amplifier of a frequency-modulated transmitter.

accentuator A network, or circuit, used for accentuation.

acceptance test A test made to demonstrate the degree of compliance of a device with the purchaser's requirements.

acceptor circuit A series resonant circuit; that is, a circuit having minimum impedance at its resonant frequency.

accumulator British term for storage battery.

accuracy Freedom from mistakes or errors. Accuracy refers to over-all final results, while precision refers only to the accuracy of the measuring instrument used.

a-c/d-c receiver A radio receiver designed to operate either from an alternating-current or a direct-current power line. Often called *universal receiver*.

acetate The basic ingredient in certain varnish formulas originally used for coatings of instantaneous recording disks. Modern disks employ different and superior coatings.

acetate disk A phonograph record made from an acetate compound.

a-c generator 1. A rotating electric machine, generally known as an *alternator*, that converts mechanical power into alternating-current power. 2. A vacuum-tube oscillator, or any other device, that is designed for the purpose of producing an alternating current.

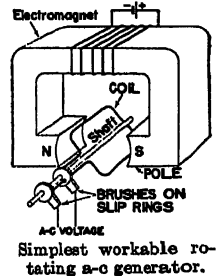

ACHROMATIC LENS

achromatic lens A lens that has been corrected for chromatic aberration. Ordinarily, the correction consists of attempting to combine all colors of light rays at the same point of focus in order to produce an image that is almost free from color fringes. This is accomplished by combining a convex lens of crown glass with a concave lens of flint glass.

isoclinic lines On a magnetic map, lines passing through points of equal magnetic inclination or dip. Also called *isoclinic lines*.

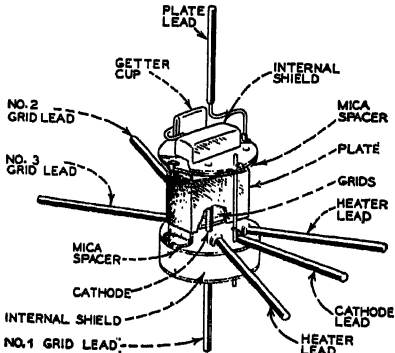
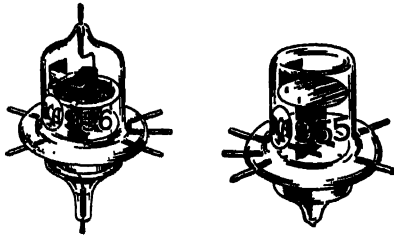

Acorn tubes, with constructional details of a typical tube.

acorn tube An acorn-shaped vacuum tube designed for ultrahigh frequencies, having low interelectrode capacitance because of the small size of the electrodes, and low electron transit time because of close spacing of the electrodes. The electrode leads are brought directly out through the sides of the tube, there being no base.

acoustic 1. The science that deals with the production, transmission, and effects of sound. 2. Those charac-

teristics of a room or location which control the reflections of sound waves and therefore determine the effectiveness of a public-address system at that location. The acoustics of a room are good if sounds can be heard distinctly by listeners in all parts of the room.

acoustic absorptivity The ratio of the sound energy absorbed by a surface to that arriving at the surface.

acoustic capacitance See *acoustic compliance*.

acoustic clarifier A system of cones loosely attached to the baffle of a loudspeaker and designed to vibrate and absorb energy during sudden loud sounds in order to suppress these sounds.

acoustic compliance 1. A measure of the volume displacement of a sound medium when subjected to sound waves. 2. That type of acoustic reactance which corresponds to capacitive reactance in an electrical circuit. Also known as *acoustic capacitance*.

acoustic feedback The feedback of sound waves from a loudspeaker to a preceding part of an audio system, such as to the microphone, in such a manner as to aid or reinforce the input. This generally causes howling. Also called *acoustic regeneration*.

acoustic filter A sound-absorbing device that selectively suppresses certain audio frequencies.

acoustic impedance The acoustic impedance, on a given surface of a sound medium, is the force per unit area on the surface divided by the flux through that surface. It is expressed in ohms and is equal to the mechanical impedance divided by the surface area. The real component of acoustic impedance is acoustic resistance, and the imaginary component is acoustic reactance.

acoustic inertance That type of acoustic reactance which corresponds to inductive reactance in an electrical circuit. It results from the inertia or the effective mass of the medium, and is expressed in acoustic ohms.

acoustic intrusion detector A burglar alarm that is responsive to sounds produced by an intruder. It generally consists of one or more microphones, concealed or otherwise mounted near the vault or other object to be protected, connected to audio amplifiers that transmit a warning signal and give an alarm when sounds exceed a predetermined normal level.

acoustic labyrinth A special baffle arrangement used with a loudspeaker to prevent cavity resonance and reinforce bass response.

acoustic line The acoustic equivalent of the sound chamber at the rear of a loudspeaker.

acoustic ohm An acoustic resistance, acoustic reactance, or acoustic impedance has a magnitude of one acoustic ohm when a sound pressure of one dyne per square centimeter produces a volume velocity of one cubic centimeter per second.

Acousticon A type of hearing aid having a construction similar to that of a telephone receiver.

acoustic pickup The pickup employed in early nonelectrical phonographs, in which the needle was directly linked to the flexible diaphragm of the sound box.

acoustic radiator That part of a loudspeaker, headphone, or other sound-producing device at which sound waves originate. Examples of acoustic radiators are the cone of a loudspeaker and the diaphragm of a headphone unit.

acoustic reactance The imaginary component of acoustic impedance. Acoustic reactance depends on the inertia and elasticity of the medium through which the sound travels, and is expressed in acoustic ohms.

acoustic regeneration The feedback of sound waves from a loudspeaker to a preceding part of an audio system, such as to the microphone, in such a manner as to aid or reinforce the input. This generally causes howling. Also called *acoustic feedback*.

acoustic resistance The real component of acoustic impedance. Acoustic resistance is responsible for the dissipation of energy due to friction between the molecules of the air or other medium through which sound travels. It is expressed in acoustic ohms and is analogous to electrical resistance.

acoustic treatment The use of sound-absorbing materials to give a room a desired degree of freedom from echo and reverberation.

a-c plate resistance The opposition that the plate circuit of a vacuum tube offers to a small increment of plate voltage. It is the ratio of a small change in plate voltage to the resulting change in plate current, other tube voltages remaining constant. Alternating-current plate resistance is usually designated by R_p and is expressed in ohms. Often called *dynamic plate resistance*.

a-c receiver A radio receiver designed to operate only from an alternating-current power line.

a-c resistance The total resistance offered by a device in an alternating-current circuit, including resistance due to eddy current, hysteresis, dielectric, and corona losses as well as the direct-current resistance. Also called high-frequency resistance and radio-frequency resistance.

actinium A radioactive element with atomic number 89.

action current A brief and very small electric current flowing in a nerve during a nervous impulse.

activation To make active, as to make certain substances radioactive or capable of reacting to radiant energy, current flow, etc.

active electric network An electric network, or circuit, containing one or more sources of energy.

active material The lead oxides or other active substances in the plates of a storage battery. The active material undergoes reversible chemical changes

ACTIVE POWER

during the processes of charging and discharging the battery.

active power The average value of power consumed by a circuit during one complete cycle of alternating current. Also called *actual power*, *true power*, or simply *power*, and measured in watts.

active transducer A transducer containing one or more sources of power.

actual power Active power.

acute angle An angle numerically smaller than a right angle; that is, an angle less than 90 degrees.

a-c welder A welding machine utilizing alternating current for welding purposes.

acyclic Following no regularly repeated cycles of variations.

acyclic machine A direct-current machine in which the voltage generated in the active conductors maintains the same direction with respect to those conductors at all times.

adapter A device used to change the terminal arrangement of a circuit or part. *Examples:* An antenna adapter for power lines, an output meter adapter for test purposes, and a phonograph and microphone adapter for radio receivers.

Adcock antenna A directional antenna system consisting of a pair of spaced vertical wires and arranged so that the horizontal connecting wires have little or no pickup. The system is rotatable for direction-finding purposes. Sometimes the system comprises two pairs of wires mounted at right angles to each other and connected in a goniometer arrangement; in this case the structure is stationary

Adcock direction finder A spaced antenna direction finder using vertical antennas, and designed to minimize the response due to horizontally polarized components of the waves. It may employ spaced vertical dipoles (H type), may have the lower ends of opposite antennas connected directly

and symmetrically to the receiver (U type), may have the antennas coupled to the receiver by transformers and subsidiary circuits, or may have antenna-ground circuits that are made electrically symmetrical about the coupling to the receiver by the insertion of suitable impedances in the antenna circuits.

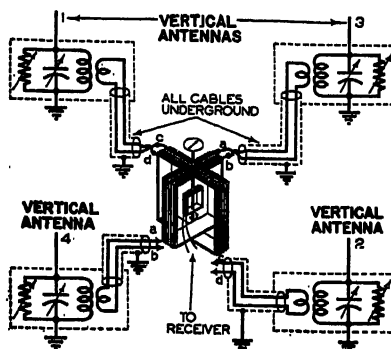

Simplified diagram of an Adcock radio direction finder.

Adcock system A radio direction-finding system utilizing an Adcock antenna.

adjacent-channel selectivity A characteristic of a receiver which governs its ability to reject stations on channels adjacent to that of the desired station.

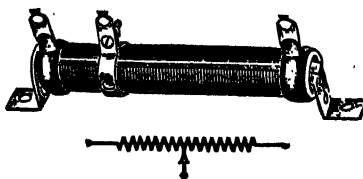

Adjustable resistor, with symbol.

adjustable resistor A resistor whose value can be changed by mechanical means. It is usually a wire-wound unit with the resistance wire partly or completely exposed.

adjustable-speed motor An electric motor whose speed can be varied over a considerable range by varying either the armature or field current or both. Usually a shunt-wound direct-current motor, which is used with electronic

AIR-CORE TRANSFORMER

motor control when operated from an alternating-current line.

adjustable voltage divider A wire-wound resistor having one or more movable terminals that can be slid along the length of the exposed resistance wire until the desired voltage values are obtained.

ad lib To speak on the spur of the moment (without a previously prepared script) during a radio broadcast or other performance.

admittance A measure of how readily alternating current will flow in a circuit. It compares with conductance in direct-current circuits, and is the reciprocal of impedance. Admittance is expressed in mhos and designated by *Y*.

Advance An alloy of copper and nickel used in the construction of electrical instruments.

advance ball A rounded support, often of sapphire, that rides ahead of or beside the cutting stylus of a sound recorder. The ball maintains a uniform depth of cut regardless of surface irregularities in the disk.

aerial A conductor or system of conductors for radiating or receiving radio waves, exclusive of the means for connecting its main portion with the associated apparatus. Now more generally called *antenna*.

aeronautical ground radio station A radio station operated for the purpose of providing point-to-point and air-ground communication in connection with the operation of aircraft.

aeronautical radio service A radio service carried on between aircraft stations and land stations and by aircraft stations among themselves. This term also applies to special radio services intended to ensure the safety of air navigation.

aeronautical radio station A land station carrying on a service with aircraft stations. It may be a fixed station assigned also to communicate with

aircraft stations; in this case it is considered as an aeronautical station only for the duration of its service with aircraft stations.

aerophare A radio beacon utilized in aeronautical services for air navigation purposes.

a-f Abbreviation for audio frequency. Same abbreviation used for noun and adjective.

afc Abbreviation for automatic frequency control.

afterglow The persistence of luminosity in a gas-discharge tube after the voltage has been removed, or the persistence of luminosity on the screen of a cathode-ray tube after the electron beam has moved.

aging Allowing a permanent magnet, capacitor, meter, or other device to remain in storage for a period of time, sometimes with voltage applied, until the characteristics of the device become essentially constant.

agriculture service A limited radio-communication service carried on between point-to-point stations for the transmission of agricultural-market information.

AIEE Abbreviation for American Institute of Electrical Engineers.

air capacitor A capacitor having only air as the dielectric material between its plates.

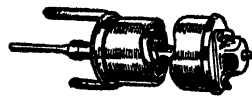

Air trimmer capacitor.

air-core coil A coil with no iron in its magnetic circuit (no iron inside or outside the wire).

air-core transformer A transformer having two or more coils wound on a fiber or other nonmagnetic form, and having no iron in its magnetic circuits. Usually designed for use as a radio-frequency transformer, inter-

AIRCRAFT BONDING

mediate-frequency transformer, antenna coil, or oscillator coil.

aircraft bonding Electrically connecting all metal parts of an aircraft, including the engine and all metal covering on wiring, to prevent electric interference with radio communication and to prevent fires arising from arcing between adjacent metallic parts due to static electricity or radio-frequency voltages.

aircraft radio station A radio station on board any aircraft.

air-ground radio frequency A frequency specified or agreed upon for transmissions from an aircraft station to an aeronautical ground station. Transmissions in the opposite direction use a ground-air radio frequency.

air navigation radio aids Aeronautical ground stations, aeronautical radio beacons, aeronautical direction-finding, and similar aids.

airplane dial A radio receiver dial having a pointer rotating over a scale to indicate the frequency of the station to which the receiver is tuned.

airplane insulator A streamlined insulator used for radio antennas on aircraft and other antennas.  Airplane insulator.

airport control station A radio station provided for furnishing communications limited to actual aviation needs between an airport control tower and aircraft stations in the immediate vicinity of the airport.



An airport control station controls, by radio, the landing and takeoff of all traffic.

airport runway beacon A radio-range beacon that defines one or more approaches to an airport.

airport traffic control tower A facility established to provide adequate supervision of air traffic within an airport control sector by means of radio, lights, or other signals.

alcohol torch A torch that uses alcohol for fuel and provides a flame of sufficient temperature for soldering purposes.

Alexanderson alternator A mechanical alternating-current generator used in the early days of radio to generate radio-frequency energy for transmission.

align 1. To adjust two or more resonant circuits so they will satisfactorily respond to a given frequency.
2. To position parts so they are all in a straight line or so that mounting holes coincide.

aligning plug The plug in the center of the base of an octal, loktal, or other tube, having a single vertical projecting rib that prevents the tube from being inserted incorrectly in its socket.



Aligning tools.

aligning tool A small screwdriver, socket wrench, or special tool constructed partly or entirely of non-magnetic materials. Such a tool is used to align or neutralize radio circuits by adjusting trimmer capacitors or adjustable coils provided for the purpose.

alignment The process of adjusting tuned circuits in radio equipment in order that they will respond properly to a given frequency.

alignment chart A chart or diagram on which equations can be solved

ALTERNATING CURRENT

graphically by placing a straightedge on the two known values and reading the answer where the straightedge crosses the scale for the unknown value. Also called *nomogram* or *nomograph*.

alive A term applied to a circuit that is connected to a source of voltage.

Allen screw A setscrew or cap screw having a hexagonal hole or socket in the head.

Allen wrench A wrench, consisting essentially of a hexagonal rod, used to turn an Allen screw.

alligator clip A long, narrow spring clip with meshing jaws. Mainly used with test leads to make temporary connections quickly.

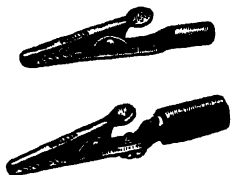

Alligator clips.

all-metal tube A vacuum tube having a metal envelope, with electrode leads passing through glass beads fused into the metal housing. All-metal tubes for receiving circuits have an octal base. Usually called *metal tube*.

alochromatic Having photoelectric properties due to microscopic particles occurring naturally in a crystal or as a result of exposure to certain radiations. A crystal is *idiochromatic* when its photoelectric properties are characteristic of the pure crystal material itself.

alloy A mixture or combination of two or more metals. *Example:* Brass is an alloy of copper and zinc.

all-pass filter A filter having zero attenuation for all frequencies from zero to infinity. It can be used to introduce phase shift without affecting attenuation, as in a phase equalizer, or it can be used to introduce a time delay.

Allström relay A highly sensitive relay in which an electromagnet, energized by the weak current to be detected, deflects a mirror and causes a beam of light to fall on a selenium cell, producing therein a change of current that actuates an ordinary relay.

all-wave antenna A receiving antenna so constructed that it responds reasonably well to a wide range of frequencies.

all-wave oscillator See *all-wave signal generator*.

all-wave receiver Term commonly used to designate a radio receiver capable of being tuned from about 535 to at least 20,000 kilocycles.

all-wave signal generator A test instrument capable of generating an unmodulated or tone-modulated radio-frequency signal at any frequency needed for aligning or servicing radio receivers and amplifiers. Also called an *all-wave oscillator*, *signal generator*, or *test oscillator*.

alnico An alloy consisting chiefly of aluminum, nickel, and cobalt. It has high retentivity and is used to make powerful small-size permanent magnets which hold their magnetism indefinitely.

alpha Greek letter α . Often used to designate angles or quantities.

alpha particles Positively charged particles, each consisting of a helium nucleus (four protons and two electrons), given off by radioactive bodies.

alpha rays Rays of alpha particles emitted from certain types of radioactive elements. They are slightly deflected by a magnetic field and are powerful ionizers.

alternating current An electric current that is continually varying in value and reversing its direction of flow at regular intervals. Each repetition, from zero to a maximum in one direction and then to a maximum in the other direction and back to zero, is called a cycle. The number of cycles occurring in one second is called the frequency.

ALTERNATING QUANTITY

alternating quantity A periodic quantity whose average value is zero over a complete cycle.

alternating voltage The voltage developed across a resistance or impedance through which alternating current is flowing. This voltage is continually varying in value and reversing its direction at regular intervals. See *alternating current*.

alternation One half of a cycle, consisting of a complete rise and fall of voltage or current in one direction. *Example:* There are 120 alternations per second in 60-cycle alternating current.

alternator An electric generator that generates an alternating voltage when its rotor or stator is rotated by a motor, an engine, or other means.

alternator transmitter A radio transmitter that utilizes radio-frequency power generated by a radio-frequency alternator, such as the Alexanderson alternator.

altimeter An instrument used in air navigation to indicate the vertical distance above a specified plane. This plane may be sea level, ground level at the point of measurement, or ground level at some other point to which the altimeter was originally calibrated. Ordinary altimeters utilize changes in barometric pressure with altitude. Modern electronic altimeters depend on the time it takes for a sound wave or a radio wave to travel down to earth and be reflected back to the aircraft.

altitude The perpendicular distance from a reference line or level to an object or point in space.

aluminum A lightweight silvery white metal used extensively in radio for foil plates of capacitors, for housings, for shielding purposes, for plates of tuning capacitors, etc.

aluminum base The aluminum disk on which a lacquer or other coating is applied in some types of recording disks.

a-m Abbreviation for amplitude modulation. Same abbreviation used for noun and adjective.

amateur A person who operates and experiments with transmitters, receivers, or other electronic equipment as a hobby and not for profit. Sometimes called a *ham*.

amateur bands Bands of frequencies assigned exclusively to radio amateurs.

amateur operator A person holding a license, issued by the Federal Communications Commission or by corresponding authorities in other countries, authorizing that person to operate a licensed amateur radio station.

amateur portable-mobile station An amateur station that may be conveniently transferred to or from a mobile unit and is ordinarily used while such mobile unit is in motion.

amateur portable station An amateur station that may conveniently be moved about from place to place but is not operated while in motion.

amateur radio communication Radio communication between amateur stations solely with a personal aim and without pecuniary interest.

amateur service A radio service carried on by amateur stations.

amateur station A radio station owned and operated by an amateur for personal two-way communication with other amateurs, and licensed accordingly by the Federal Communications Commission or by corresponding authorities in other countries.

amateur station call letters A group of letters and numbers assigned to a licensed amateur for identification purposes when on the air. United States amateur calls begin with W (K for United States possessions), followed by a location-indicating numeral and two or more additional letters.

amber A yellowish or reddish-brown translucent fossil resin having excellent insulating qualities.

AMPLIFICATION FACTOR

ambient temperature The temperature of the air in the immediate vicinity.

American Morse code A dot-dash code used in wire telegraphy. It differs considerably from the International Morse code used in radio, having a different spacing method and some entirely different letter codes.

American wire gage The system commonly used in the United States for specifying the size of a conductor. Wire sizes range from 0000 for the largest (0.46 inch diameter) to 40 and higher for the smallest diameters. Abbreviated AWG. Formerly called Brown and Sharpe gage (B & S gage).

ammeter An instrument used for measuring the amount of current in amperes. A meter that indicates the current value in milliamperes is a *milliammeter*, and one that indicates values in microamperes is a *microammeter*.

amp Abbreviation for ampere, the practical unit of current.

amperage 1. The amount of current in amperes. 2. The maximum current indicated by an ammeter of the dead-beat type when connected directly to the terminals of a primary coil or battery by wires which together with the meter have a resistance of 0.01 ohm.

ampere The practical unit of current. One ampere will flow through a resistance of one ohm when a difference of potential of one volt is applied across its terminals.

ampere-hour A unit of quantity of electricity equal to a current of one ampere flowing for one hour. Multiplying current in amperes by the time in hours which it flows gives ampere-hours. This rating is used chiefly to indicate the amount of energy that a storage battery can deliver before it needs recharging, or that a primary battery can deliver before it needs replacing.

ampere-hour capacity The number of ampere-hours that can be delivered

by a storage battery or other battery under specified conditions of temperature, rate of discharge, and final voltage.

ampere-hour meter A meter that registers the quantity of electricity in ampere-hours.

Ampère's law The magnetic intensity at any point near a current-carrying conductor can be computed on the assumption that each infinitesimal length of the conductor produces at the point an infinitesimal magnetic density. The resulting magnetic intensity at the point is the vector sum of the contributions of all the elements of the conductor. Also called *Biot-Savart's law*, but neither man stated this law in its final differential form.

Ampère's rule The magnetic field surrounding a conductor will have a counterclockwise direction when the electron flow is away from the observer.

ampere-turns The product obtained by multiplying the number of turns in a coil by the current in amperes flowing through the coil.

amp-hr Abbreviation for ampere-hour.

amplidyne A dynamoelectric amplifier for power control, having a construction like that of a generator but utilizing special windings in such a way that amplification ratios as high as 10,000:1 may be obtained.

amplification The process of increasing the strength (current, voltage, or power) of a signal. Voltage amplification is the ratio of the output signal voltage to the input signal voltage. Current amplification is the ratio of the output signal current to the input signal current. Power amplification is the ratio of the signal power delivered by the output circuit to the signal power supplied to the input circuit.

amplification factor The ratio of the change in plate voltage to a change in control-electrode voltage, under the conditions that the plate current remains unchanged and that all other

AMPLIFIER

electrode voltages are maintained constant.

amplifier A device for increasing the power associated with a phenomenon (such as a signal) without appreciably altering its quality. An amplifier usually contains one or more vacuum tubes and associated parts. Basic types of amplifier circuits used in radio are *class A, AB, B, and C amplifiers*. The output wave of an amplifier is an enlarged reproduction of the essential features of the input wave.

amplify To increase in magnitude.

amplitude The amount of variation of an alternating quantity from its zero value.

amplitude distortion A type of distortion that occurs in an amplifier or other device when output wave forms do not exactly follow those of the input voltage or current. The result is a production of harmonics that were not present in the original signal.

amplitude fading Fading in which the amplitudes of all frequency components of a modulated carrier wave are uniformly attenuated. In selective fading, only part of the modulated signal band is affected.

amplitude-frequency distortion That form of wave distortion in which the relative magnitudes of the different frequency components of the wave are changed. Also called *attenuation distortion* or *attenuation-frequency distortion*.

amplitude limiter A circuit or stage that automatically reduces the amplification for signal peaks exceeding a predetermined value, so as to maintain amplitudes of all components of a signal below this value.

amplitude-modulated transmitter A radio transmitter that transmits an amplitude-modulated wave.

amplitude-modulated wave A sinusoidal wave whose envelope contains a component similar to the wave form of the signal to be transmitted.

amplitude modulation A method of modulating a carrier-frequency current by causing the amplitude of this current to vary above and below its normal value in accordance with the audio or other signal to be transmitted.

amplitude resonance Resonance in which any change in the period or frequency produces a decrease in the amplitude of the oscillation of the system.

amplitude separator The television receiver circuit that separates the control impulses from video signals. Also called *clipper* or *synchronizing separator*.

analyzer 1. General term for a test instrument used in servicing radio equipment and checking radio parts. It sometimes includes a special plug-in system known as a socket analyzer, which in effect brings the terminals of a tube to the instrument itself for convenience in making measurements under operating conditions. 2. A Nicol prism or other device for detecting and testing polarized light.

anastigmatic lens A lens in which astigmatism has been corrected, so that the lens forms point images of object points.

anelectrotonus The state of reduced excitability of a nerve or muscle that is near the positive electrode or anode during passage of direct current through living tissue.

anemometer An instrument for measuring the velocity of the wind.

aneroid barometer An instrument for measuring the pressure of the atmosphere, consisting of a hollow corrugated metal container from which air has been partially exhausted. The walls are sufficiently thin so that the container changes its form in proportion to changes in air pressure. A pointer attached to the container moves over a scale calibrated to read pressure in inches of mercury or altitude in feet above sea level.

angle An angle is formed when two straight lines meet. The lines are

called the sides of the angle, and the intersection is called the vertex. An acute angle is less than 90 degrees, a right angle is 90 degrees, and an obtuse angle is greater than 90 degrees.

angle of arrival The angle made between the surface of the earth and the line of propagation of a radio wave arriving at a receiving antenna.

angle of beam That angle which encloses the greater part of the energy transmitted from a directional antenna system.

angle of departure The wave angle of the line of propagation, on departing from the transmitting antenna, of a radio wave.

angle of incidence The angle measured between a wave, ray, or beam arriving at a surface and the perpendicular to the surface at the point of arrival.

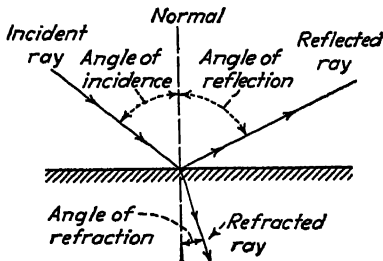

Angles involved when a ray strikes a surface.

angle of lag The angle with which one alternating electrical quantity lags behind another quantity in time, expressed in degrees (1 cycle = 360 degrees) or in radians (1 cycle = 2π radians).

angle of lead 1. The angle with which one alternating quantity leads another quantity in time, expressed in degrees or in radians. 2. The angle through which the commutator brushes of a direct-current generator or motor must be moved from the normal position to prevent sparking.

angle of radiation The angle between the surface of the earth and the center of the beam of energy radiated upward

into the sky from a transmitting antenna.

angle of reflection The angle measured between a wave, ray, or beam leaving a surface and the perpendicular to the surface.

angle of refraction The angle measured between a ray or beam refracted from a surface and the perpendicular to the surface.

angstrom unit A unit of measurement of the wavelength of light and other radiation, equal to one ten-millionth millimeter, which is 10^{-8} centimeter.

angular distance Distance expressed in radians or equivalent angular measure. It is equal to the distance in wavelengths multiplied by 2π radians or by 360 degrees.

angular frequency Frequency expressed in radians per unit of time. It is equal to the frequency in cycles multiplied by 2π . Also called *radian frequency*.

angular length The length expressed in radians or equivalent angular measure. It is equal to the length in wavelengths multiplied by 2π radians or 360 degrees.

angular velocity The speed of a rotating object measured in radians per second and generally designated by the Greek letter omega ω . In the case of a periodic quantity such as an alternating current, the angular velocity is equal to 2π times the frequency.

anion One of the negative ions that moves toward the anode in a discharge tube, electrolytic cell, or similar apparatus. The corresponding positive ion is called the cation.

aniseikon An electronic device for detecting cracks and flaws in materials and for detecting any change in the appearance of a space by projecting onto a pair of photoelectric cells the image of the space to be supervised. A grating ruled with variable-area opaque and transparent squares is mounted in front of the cells. The objects in the field of view are imaged

ANNULAR

at unequal sizes, and movement of an object transfers its image from an opaque to a transparent square in such a way as to vary the amount of light reaching one of the photoelectric cells.

annular Ring-shaped.

annunciator A signaling apparatus, generally operated electromagnetically. The electromagnet allows a small shutter to drop and reveal the number of the calling push-button station.

anode That electrode of an electron tube toward which the principal electron stream flows. It is at a positive potential with respect to the corresponding negative electrode called the cathode. In radio tubes it is usually called the plate, and is identified by the letter P.

anode current The current passing to or from an anode.

anode-ray current A current in a rarefied gas, comprising the movement of positively charged particles. Also called *positive-ray current*.

anode rays Positively charged particles that have their origin in the anode of an electron tube, and are of atomic dimensions.

anode voltage The potential difference existing between the anode and the cathode of an electron tube.

anodize To place a protective film of metal on a metal object by electrolytic action.

anolyte The solution adjacent to the anode in an electrolytic cell. The catholyte is adjacent to the cathode.

anotron A cold-cathode glow discharge vacuum-tube rectifier having a large

cathode of sodium or other material and a copper anode.

ant. Abbreviation for antenna.

antenna A conductor or system of conductors for radiating or receiving radio waves, exclusive of the means for connecting its main portion with the associated apparatus. The raised horizontal portion of an overhead antenna was formerly called an aerial.

antenna adapter An antenna eliminator.

antenna array An arrangement of two or more antennas coupled together in such a way as to give desired directional characteristics.



antenna coil That coil in a radio receiver through which antenna current flows. The coil is usually connected between the antenna and ground terminals inside the set, and is inductively coupled to a secondary coil in the grid circuit of the first stage.

antenna coupler 1. A radio-frequency transformer used to connect an antenna to a transmission line or to connect a transmission line to a radio receiver. 2. A radio-frequency trans-



VERTICAL SINGLE-WIRE ANTENNA



GUYED VERTICAL ANTENNA



SELF-SUPPORTING TOWER

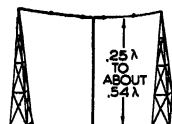

T ANTENNA



TOWER WITH TOP HAT

Types of broadcast antennas. The single towers are insulated from the ground.

ANTENNA RESISTANCE

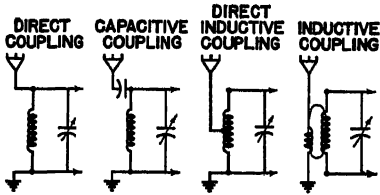

Various antenna coupling circuits for receivers.

former, link circuit, or tuned line used to transfer radio-frequency energy from the final plate tank circuit of a transmitter to the transmission line feeding the transmitting antenna.

antenna current The radio-frequency current that flows in an antenna.

antenna effect One cause of errors in a radio direction finder. It is due to capacitance between the loop antenna and the ground.

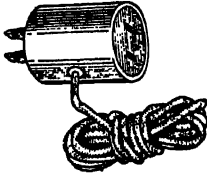

Receiving antenna substitute that uses the house wiring as an antenna. It usually contains an inductor and a capacitor.

antenna eliminator A device that permits using any wall outlet for the antenna and ground connections of a radio receiver. It ordinarily provides connections through capacitors to the power-line wires. Usually satisfactory only for local-station reception. Also called *antenna adapter*.

antenna field gain A Federal Communications Commission television standards figure of merit for the effectiveness of a transmitting antenna. It is a measure of the effective free space field intensity, measured in the horizontal plane, produced by a transmitting antenna at a distance of one mile with an antenna input power of one kilowatt. Antenna field gain is expressed in millivolts per meter.

antenna gain The effectiveness of a directional antenna in a particular direction as compared with some standard antenna. It is usually expressed as the ratio of the standard antenna power to the directional antenna power that will produce the same field strength in the desired direction. Antenna gain is usually expressed in decibels.

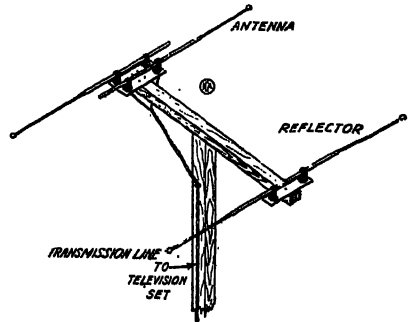
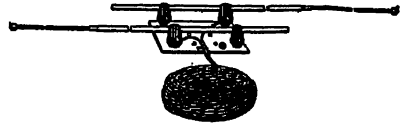

Frequency modulation and television receiving antenna covering the range of 40 to 90 megacycles and employing Q method of coupling between the transmission line and the antenna, and method of mounting this antenna on a mast with a reflector to secure directional characteristics.

antenna power The square of the antenna current of a transmitter multiplied by the antenna resistance at the point where the current is measured.

antenna reflector That portion of a directional antenna array that tends to reverse the direction of radio waves by reducing the field intensity behind the array and increasing it in the forward direction.

antenna resistance A transmitting antenna rating expressing the total resistance of the antenna system at the operating frequency. The antenna resistance in ohms is equal to the power in watts supplied to the entire antenna circuit, divided by the square of the antenna current in amperes measured

ANTICAPACITANCE SWITCH



Porcelain insulator at the foot of a steel transmitting antenna tower.

at the point where power is supplied to the antenna.

anticapacitance switch A switch designed to have minimum capacitance between its terminals.

anticathode The target of an X-ray tube, on which the stream of electrons from the cathode is focused and from which X rays are emitted. It is usually made from platinum or tungsten and is operated at a high positive potential with respect to the cathode. More often called *target*.

antilog Abbreviation for antilogarithm.

antilogarithm The number corresponding to a given logarithm. *Example:* If the logarithm of 563.2 is 2.75066, then 563.2 is the antilogarithm of 2.75066.

antimicrophonic Not affected by vibrations or by sound waves from a loudspeaker to the extent that feedback and howling occurs.

antinode Any point, line, or surface in a stationary-wave system which has maximum amplitude at all times. The type of antinode is usually specified, since there can be antinodes of voltage, current, pressure, etc. The corresponding term for zero amplitude is node.

aperiodic Having no rhythm or repetitive characteristics, or no tendency to vibrate. A circuit that will not

resonate in the tuning range is often called aperiodic.

aperiodic antenna An antenna having essentially constant impedance over a wide range of frequencies. Examples are terminated rhombic antennas and terminated wave antennas.

aperiodic damping That condition of a system in which the amount of damping is so large that, when the system is subjected to a single disturbance, the system comes to a position of rest without passing through this position. The point of change between aperiodic and periodic damping is called critical damping.

aperture The opening in a metal or other diaphragm on either side of a lens to limit the amount of light passing through the lens. In ordinary cameras and television cameras, provisions are usually made to vary the size of the aperture.

aplanatic lens A lens that has been corrected for chromatic and spherical aberration.

apochromatic lens A lens that has been corrected for chromatic aberration for three colors.

A power supply The battery, generator, or other voltage source that provides power for heating the cathodes of vacuum tubes.

apparent power The power value obtained in an alternating-current circuit by multiplying the effective values of voltage and current. The result is expressed in volt-amperes, and must be multiplied by the power factor to secure the average or true power in watts.

apparent reflectance The reflectance that a perfectly diffusing surface must have in order to produce, under the same angular conditions of illuminating and viewing, the same instrumental effect as the specimen being measured.

Applegate diagram A diagram illustrating the behavior of the electrons in a velocity-modulation tube, by showing the positions of electrons along the

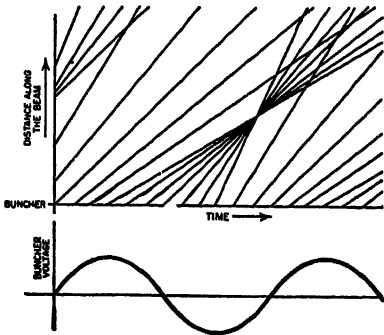

Applegate diagram showing the location of the electron bunches in a klystron velocity-modulation tube as a function of time.

drift space plotted as vertical coordinates against time along the horizontal axis.

Appleton layer A region of highly ionized air in the ionosphere, capable of reflecting or refracting radio waves back to earth under certain conditions. It is made up of the F_1 and F_2 layers, these being above the E_1 and E_2 layers that make up the Kennelly-Heaviside layer.

Aquadag A graphite coating on the inside of some cathode-ray tubes for collecting secondary electrons emitted by the screen.

arbitrary constant A constant to which various values may be assigned by decision alone, with these values being unaffected by any of the variables in an equation.

arc 1. A luminous glow formed by the flow of electric current through ionized air, gas, or vapor between separated electrodes or contacts. 2. A portion of the circumference of a circle.

arcback Sudden failure of rectifier action in a mercury-vapor rectifier tube due to an internal fault. Sometimes caused by excessive density of mercury vapor resulting from overheating of the cathode. Also called *backfire*.

arc converter A type of radio-frequency oscillator in which an electric arc is used in connection with a resonant

circuit to generate a pulsating or alternating current. In effect, an arc converter changes direct current to alternating current. Once used extensively in radio transmitters, but now found chiefly in induction heating units and occasionally in diathermy and similar medical equipment.

arc furnace An electrothermic apparatus in which heat energy is produced by the flow of electric current through one or more arcs internal to the furnace. It may be a direct-arc furnace, indirect-arc furnace, or smothered-arc furnace.

arcing The production of an arc, as at the brushes of a motor or the contacts of a switch.

arc lamp An electric lamp in which the light is produced by an arc made when a current flows through ionized gas between two electrodes.

arcronograph An apparatus for recording data on the exact cycle of current and voltage occurring in the circuit supplying a welding arc. It provides a measure of the quality of the weld and employs a thermionic tube as a relay.

arc transmitter A radio transmitter employing an arc in the generation of radio-frequency oscillations.

arc welding A fusion welding process in which welding heat is obtained from an arc either between the base metal and an electrode, or between two electrodes.

argon An inert gas that gives a purple light when ionized, sometimes used in electronic tubes, electric lamps, and neon signs.

argument 1. One of the independent variables upon which the value of a function depends. 2. The angle that fixes the direction of a complex number.

arithmetic mean The average of a number of quantities, obtained by adding the quantities and dividing the result by the number of quantities involved.

ARMATURE

armature 1. A piece of ferromagnetic material that is placed between or across the pole pieces of a magnet in such a manner that it may have motion relative to the pole pieces. 2. The pivoted or spring-mounted iron portion of a magnetic loudspeaker, buzzer, relay, magnetic phonograph pickup, or other electromagnetic device that depends on physical motion of a part of its magnetic circuit. 3. The rotating part of an ordinary electric motor or generator, carrying conductors that move through the magnetic field between the pole pieces.

armature reaction Interaction between the magnetic flux of the armature and that of the field in an electric motor or generator, causing a redistribution of flux that must be taken into account during design.

armature-voltage control Controlling the speed of a motor by changing the voltage applied to its armature windings.

armored cable A cable provided with a sheath of metal primarily for mechanical protection.

Armstrong oscillator

A tuned grid-tuned plate oscillator circuit developed by E. H. Armstrong. A parallel resonant circuit serves as the required inductive plate load when tuned slightly above the resonant frequency of the grid tank circuit or crystal. Feedback is accomplished through the interelectrode capacitance of the oscillator tube.

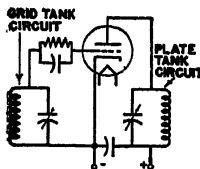

Armstrong oscillator.

array A combination of antennas with suitable spacing and with all elements excited so as to make the radiated fields from the individual elements add in the desired direction.

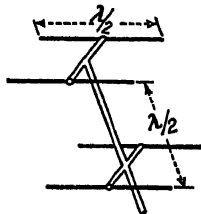

Array of stacked dipoles with reflectors. Sometimes used with television receivers.

arrester 1. A protective device used to provide a bypass path directly to ground for lightning discharges that strike an antenna or other conductor. Usually called *lightning arrester*. 2. A power-line device that is capable of reducing the voltage of a surge applied to its terminals, interrupting current flow if present, and restoring itself to original operating conditions.

ARRL Abbreviation for American Radio Relay League, the largest amateur radio organization in the world. It publishes the monthly magazine *QST*.

artificial antenna A resistor or other device that has the electrical characteristics of a particular antenna but does not radiate an appreciable amount of energy. Used chiefly for testing and adjusting transmitters. More often called *dummy antenna*.

artificial line Apparatus that simulates the electrical characteristics of a transmission line.

artificial radioactivity The production, without the use of radium, of radiation similar to that produced by the disintegration of radium. It can be accomplished with apparatus such as the cyclotron, or by bombarding certain materials with alpha particles.

ASA Abbreviation for American Standards Association.

asbestos A nonflammable fibrous mineral used in electronics for heat-insulating and fireproofing purposes, as in a line cord resistor.

ASCAP Abbreviation for American Society of Composers, Authors, and Publishers.

asdic British term for listening devices used on vessels for submarine-detecting purposes.

ASME Abbreviation for American Society of Mechanical Engineers.

aspect ratio The numerical ratio of frame width to frame height. In television the aspect ratio of the transmitted picture has been standardized at four units horizontally to three units vertically.

astatic 1. Without any particular orientation; having no directional characteristics. 2. Being in neutral equilibrium; having no tendency toward any change of position.

astatic galvanometer A sensitive galvanometer consisting of two very small magnetized needles arranged parallel to each other with north and south poles adjacent and suspended inside the galvanometer coil. The double needles reduce the effect of the earth's magnetic field.

astatic microphone A nondirectional microphone.

astigmatism A type of spherical aberration in which rays from a single point of an object do not converge in the image. Astigmatism in a lens or mirror causes a blurred image.

ASTM Abbreviation for American Society for Testing Materials.

A supply The A battery, transformer filament winding, or other voltage source that supplies power for heating the cathodes of vacuum tubes.

asymmetrical Not symmetrical.

asymptotic Having or pertaining to the characteristics of an asymptote, which is a line representing the limiting position that the tangent of a curve approaches as the point of contact recedes.

asynchronous Not synchronous.

asynchronous machine A machine in which the speed of operation is not proportional to the frequency of the system to which it is connected.

asynchronous spark gap A rotary spark gap without provision for sparking at definite points in the cycle of the alternating-current supply.

a-t Abbreviation for ampere-turn.

A T-cut crystal A quartz crystal slab cut at a 35-degree angle to the Z axis of the mother crystal. It has low drift in frequency with temperature variations.

atm Abbreviation for atmosphere.

atmosphere The mixture of gases, chiefly oxygen and nitrogen, which surrounds the earth for a distance of about 100 miles from the surface. Atmospheric pressure at the surface of the earth is approximately 15 pounds per square inch; hence this value is often used as a unit of pressure which is called one atmosphere.

atmospheric absorption Loss of power occurring during transmission of radio waves due to absorption in the atmosphere.

atmospheric interference Interference to radio reception due to electrical disturbances and lightning in the atmosphere. Also known as *atmospherics*, *QRN*, or *static*.

atmospheric noise Noise heard during radio reception due to atmospheric interference.

atmospheric radio wave A radio wave that reaches its destination after reflection or refraction from the upper ionized layers of the atmosphere.

atmospherics Noise heard during radio reception due to atmospheric interference.

atom One of the elemental particles that make up all matter. An atom is the smallest particle into which matter can be divided and still retain all the chemical properties of the element. There are only 92 known kinds of atoms, each being made up of a different arrangement of electrons and protons.

atomic hydrogen welding An alternating-current arc-welding process in which welding heat is obtained from an arc between two suitable electrodes in an atmosphere of hydrogen.

atomic number The number assigned to an element when all 92 elements are arranged in the order of the complexity of the atom. Numbering starts from the simplest atom, that of hydrogen. The atomic number is supposed to represent the number of electrons believed to surround the nucleus of the atom.

ATOMIC THEORY

atomic theory The generally accepted theory, concerning the structure and composition of substances and compounds, that everything is composed of various combinations of atoms, of which only 92 known kinds exist. All the atoms of any one of these 92 elements are uniform in size, weight, and other properties.

atomic weight The relative weight of an atom, based on an atomic weight of 16 for the oxygen atom. On this basis, hydrogen has an atomic weight of 1.0078.

attenuation The decrease in the intensity of energy, such as sound waves and radio waves.

attenuation constant The real part of the propagation constant. The imaginary part is the phase constant or wavelength constant.

attenuation distortion See *attenuation-frequency distortion*.

attenuation equalizer An equalizer used to change the transmission loss of a line or circuit at certain frequencies in order to make the total transmission loss essentially the same for all frequencies in the range being transmitted.

attenuation-frequency distortion That form of wave distortion in which the relative magnitudes of the different frequency components of the wave are changed. Also called *amplitude-frequency distortion* or *attenuation distortion*.

attenuation ratio The magnitude of the propagation ratio; that is, the ratio indicating the relative decrease in energy.

attenuator An arrangement of variable resistors used to reduce the strength of an audio-frequency or radio-frequency signal a desired amount without causing appreciable distortion. The corresponding nonadjustable device is called a pad.

attraction A force that tends to make two objects approach each other. Attraction exists between two unlike magnetic poles (N and S) or between two unlike static charges (+ and -).

at wt Abbreviation for atomic weight.

Au Chemical symbol for gold.

audibility A measure of the strength of a signal or sound as compared with the strength required to produce a sound that can just be heard. Audibility is usually expressed in decibels.

audible Capable of being heard by the average human ear. The approximate range of human hearing is between 20 and 20,000 cycles per second, but actual limits vary greatly with different individuals.

audio Pertaining to frequencies of normally audible sound waves (between about 20 and 20,000 cycles per second).

audio amplifier An audio-frequency amplifier.

audio frequency Any frequency in the range from 20 to 20,000 cycles per second, corresponding to audible sound waves.

audio-frequency amplifier One or more vacuum-tube circuits used for amplifying an audio-frequency signal. Often called *audio amplifier*.

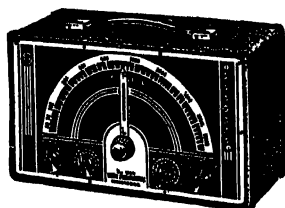

An audio-frequency oscillator that can be set to produce any frequency from about 50 to 15,000 cycles.

audio-frequency oscillator 1. An instrument having vacuum-tube circuits that can be set to generate any desired audio-frequency voltage. Often called *audio oscillator*. 2. An audio-frequency oscillator that is operated by a telegraph key and used for code practice.

audio-frequency transformer An iron-core transformer used for coupling

AUTOMATIC-ALARM RECEIVER

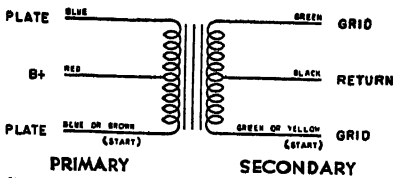

Color code for leads of interstage and output audio-frequency transformers. With a single primary and/or a single secondary, the upper two leads of each winding here show the color coding. Brown and yellow leads are used when the polarity is important, to indicate starting lead (inner end of winding).

between audio-frequency circuits. Often called *audio transformer*.

audiometer An instrument used to test the power of hearing or the intensity or audibility of sounds. It consists of an audio oscillator having variable calibrated output and capable of generating a wide range of audio frequencies.

audion A three-electrode vacuum tube; originally a trade-mark for the triode invented by Dr. Lee de Forest.

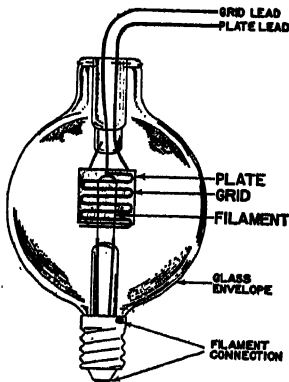

De Forest audion radio tube.

audio oscillator An audio-frequency oscillator.

audio peak limiter A circuit used in an audio-frequency system to suppress audio peaks that exceed a predetermined value. Used in the audio-frequency system of a radio transmitter to prevent overmodulation and to protect equipment from overloading.

audio signal A signal of audible frequency.

audio transformer An audio-frequency transformer.

audition A studio test or rehearsal of a part or all of a program prior to a radio broadcast.

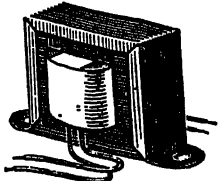

Audio-frequency transformer.

aural Pertaining to the ear or the sense of hearing.

aural signal The signal corresponding to the sound portion of a television program. The use of frequency modulation with a maximum frequency swing of 75 kilocycles and a center frequency 4.5 megacycles above the visual carrier is now standard for transmission of the aural portion of a television program.

aural transmitter The radio equipment used for the transmission of the aural (sound) signals from a television broadcast station. The complete equipment for both visual and aural signals is known as a television transmitter.

autocondensation A method of applying high-frequency currents for therapeutic purposes, in which the patient becomes one part of a capacitor.

autoconduction A method of applying high-frequency currents for therapeutic purposes by magnetic induction. The patient is placed inside a large solenoid (coil), and the therapeutic current is produced by electromagnetic induction.

autodyne reception An early receiver arrangement in which a single vacuum tube served both as an oscillator and a detector in a type of heterodyne reception involving production of a beat frequency. The British equivalent was called *endodyne reception*.

automatic Having a self-acting mechanism or arrangement that performs a required act at a predetermined time or condition.

automatic-alarm receiver A complete receiving, selecting, and warning

AUTOMATIC-ALARM-SIGNAL

device capable of being actuated automatically by intercepted radio-frequency waves forming the international automatic alarm signal.

automatic-alarm-signal keying device

A device capable of automatically keying the radiotelegraph transmitter on board a vessel so as to transmit the international automatic-alarm signal.

automatic bass compensation An extra circuit used in some receivers to make bass notes sound more natural at low volume-control settings. The circuit usually consists of a resistor and capacitors and automatically compensates for the poor response of the human ear to weak low-frequency sounds.

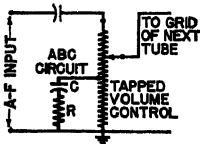

Automatic bass compensation circuit.

automatic brightness control A circuit used in a television receiver to keep the average brightness of the reproduced image essentially constant. Its action is like that of an automatic-volume-control circuit in a sound receiver.

automatic C bias Automatic grid bias.

automatic circuit breaker A device that automatically opens a circuit, usually by electromagnetic means, when the current exceeds a safe value.

automatic control An arrangement of electric controls that provides for opening and/or closing, in an automatic sequence and under predetermined conditions, the switching devices which thereupon maintain the required character of service and provide adequate protection against all usual operating emergencies.

automatic cutout A device, usually operated either by centrifugal force or by an electromagnet, that automatically

removes (cuts out) some part of a circuit at the proper moment. Used on some induction motors to cut out the starting winding when operating speed is attained.

automatic frequency control A special circuit used to keep a superheterodyne receiver tuned accurately to a given station. It was used on some push-button receivers to correct the operation of automatic tuning systems.

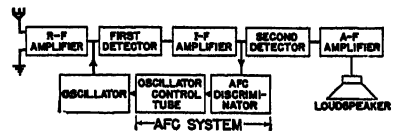

Automatic frequency control applied to a superheterodyne receiver.

automatic gain control A circuit arrangement that automatically maintains the output volume of a radio receiver essentially constant despite variations in input signal strength during fading or when tuning from station to station. This is accomplished by reducing the over-all amplification as the strength of the carrier wave increases, and vice versa. The term is usually applied to automatic compensation for changes in signal level in audio or video circuits. Also called *automatic volume control*.

automatic grid bias Production of grid bias voltage by a vacuum tube itself, by the flow of plate or other electrode currents through a resistor in the cathode lead. The resulting voltage drop across this resistor serves as the grid bias, thereby eliminating the need for a separate C bias voltage source.

automatic machine equipment Equipment that provides automatic control for any type of rotating machine or rectifier.

automatic radio compass A radio direction finder having provisions for rotating the loop automatically to the correct position, so that a pilot can secure a radio bearing simply by glancing at the indicator dials, without

AUTOMATIC VOLUME CONTROL

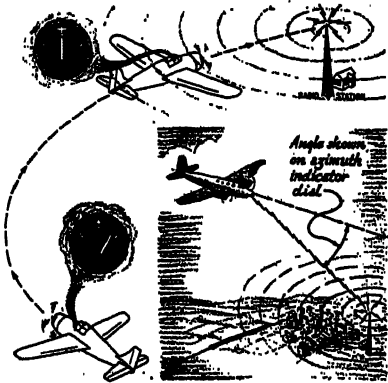

Left-right indicator and azimuth indicator of an automatic radio compass together show the direction to a radio station in much the same way as a magnetic compass points to the magnetic north pole.

making mechanical adjustments and without calculations.

automatic record changer An electric phonograph that automatically plays a number of records one after another. The more common types play only one side of each record. Other types play both sides, either by turning over the record automatically or by using two pickups, one upside down so it acts on the bottom of the record.

automatic regulator A device for regulating a system in such a manner that changes in its operation are initiated by changed conditions and carried out without the intervention of an attendant.

automatic starter A device that performs in correct sequence the required steps in starting a motor, machine, radio transmitter, etc.

automatic station A generating station, substation, radio station, etc. (usually unattended) that under predetermined conditions goes into operation automatically in correct sequence, maintains the required character of service by automatic means, provides protection against usual operating emergencies, and goes out of operation by automatic sequence under other predetermined conditions.

automatic telephone system A telephone system in which special relays or stepping switches connect calling and called lines in response to impulses produced by the dial at the calling station. Except under special conditions, no operators are required.

automatic time switch A combination of a switch with an electric or spring-wound clock, arranged to turn electric circuits on and off at predetermined times.

automatic transfer equipment Equipment that automatically transfers a load in order to permit selecting a source of power from one of several incoming power lines.

automatic transformer equipment Equipment that provides automatic control for connecting and disconnecting additional transformer capacity at an automatic station in response to overload and underload, respectively, of predetermined values for predetermined periods of time.

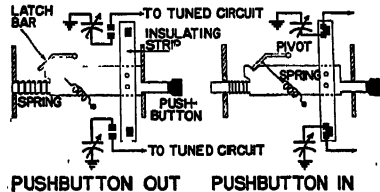

Electrical automatic-tuning system.

automatic tuning An electrical, mechanical, or electromechanical system that tunes a radio receiver automatically to a predetermined station when a button or lever is pressed.

automatic volume control A circuit arrangement that automatically maintains the output volume of a radio receiver essentially constant despite variations in input signal strength during fading or when tuning from station to station. This is accomplished by reducing the over-all amplification as the strength of the carrier wave increases, and vice versa. The term is usually applied to automatic compensation for changes in signal level in radio-frequency or interme-

AUTOMATIC VOLUME EXPANSION

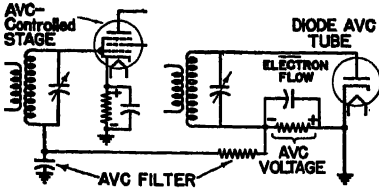

An automatic volume-control circuit in which the diode detector also provides the control voltage.

diode-frequency circuits. Often called *automatic gain control*.

automatic volume expansion A special audio-frequency circuit that increases the volume range of a radio program or phonograph record by making loud portions louder and weak portions weaker. Since the volume range of a program is generally contracted at the point of broadcast, automatic volume expansion tends to make radio reception more nearly like the actual program.

automatic welding Welding with equipment that automatically controls the entire welding operation including feed, speed, rate of interruption, etc.

automaton Any device or mechanism that imitates human actions.

auto radio Popular term for a radio receiver designed for installation in an automobile, usually behind the instrument panel. Filament voltages are obtained directly from the 6-volt automobile storage battery, and the required higher direct voltages are usually obtained from a vibrator-type power pack built into the receiver.

Autosyn A Bendix-Marine trade name, derived from automatically synchronous. It is equivalent to such other trade names as mag-slip, motor-torque generator, selsyn, and Siemens, all of which are equal to the universal term synchro.

autotransformer A power transformer having one continuous winding that is tapped. Usually a part of the winding serves as the primary, and all of it serves as the secondary.

auxiliary transmitter A transmitter maintained only for transmitting the regular programs of a station in case of failure of the main transmitter.

available line The portion of the scanning line that can be used specifically for picture signals in a facsimile system. It may be expressed as a percentage of the length of the scanning line.

avc Abbreviation for automatic volume control.

ave Abbreviation for automatic volume expansion.

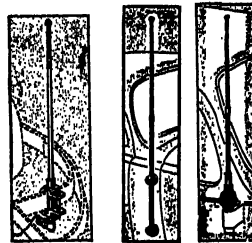

Bumper Cowl Hinge

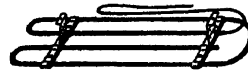

Running Board



Top

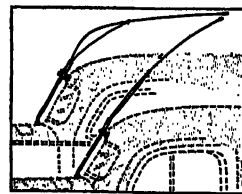

Whip

Types of auto radio antennas.

average value. 1. The value obtained by dividing the sum of a number of quantities by the number of quantities represented. 2. The average of many instantaneous amplitude values taken at equal intervals of time during an alternation (half-cycle) of alternating current. The average value of an

AZIMUTH INDICATING METER

alternation of a pure sine wave is 0.637 times its maximum or peak amplitude value.

avg Abbreviation for average.

aviation channel A band of frequencies assigned for radio communication between aircraft and ground stations.

aviation service A radio-communication or special service carried on by aircraft stations, airport control stations, aeronautical stations, aeronautical fixed stations, instrument landing stations, and flying-school stations.

avigation The science of conducting airplanes from one place to another and determining position.

Avogadro's number The number of molecules in a mass numerically equal to its molecular weight. The number is 6.06×10^{23} molecules.

AWG Abbreviation for American wire gage.

axial leads Leads coming out from the

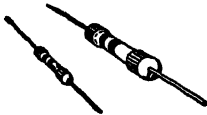

Axial leads on carbon resistors.

ends and along the axis of a resistor, capacitor, or other part.

axiom A self-evident truth that is universally accepted.

axis 1. A central line, real or imaginary, with respect to geometric shape. 2. A line about which a body revolves or may revolve.

Ayrton shunt A type of shunt devised by Ayrton to increase the range of a galvanometer without changing the damping. Also called *universal shunt*.

azimuth The angular measurement in a horizontal plane and in a clockwise direction, beginning at a point oriented to north.

azimuth angle That component of a wave angle which is measured about a vertical axis, clockwise from north, and indicates direction in the plane of the earth's surface.

azimuth indicating meter A ground-station receiver used at airports to determine the azimuth angle of arrival of signals from an airplane. The direction of arrival is shown on the screen of a cathode-ray tube and can be radioed to a pilot coming in through fog or darkness.

B

- B** Letter used to identify the plate-voltage supply of a vacuum tube.
- B** 1. Symbol for magnetic induction, which is the same as magnetic flux density and is measured in gaussess. 2. Symbol for susceptance.
- B+** (B plus, or B positive.) The positive terminal of a B battery or other plate-voltage source for a vacuum tube, or the plate-circuit terminal to which the positive source terminal should be connected.
- B-** (B minus, or B negative.) The negative terminal of a B battery or other plate-voltage source for a vacuum tube, or the plate-circuit terminal to which the negative source terminal should be connected.
- babble** The combined crosstalk from a large number of disturbing channels.
- back electromotive force** The voltage developed in an inductive circuit by a changing or alternating current flowing through the circuit. The polarity of the voltage is at each instant opposite that of the applied voltage, and the amplitude or strength is never greater than that of the applied voltage. Also called *counter electromotive force*.
- back emf** Abbreviation for back electromotive force.
- backfire** Sudden failure of rectifier action in a mercury-vapor rectifier tube due to an internal fault. Sometimes caused by excessive density of mercury vapor resulting from overheating of the cathode. Also called *arcback*.
- background** 1. Music or sound effects produced at a lower volume level along with a regular radio program. 2. The setting behind the performers in a television program.
- background noise** Noise heard with a radio program due to atmospheric interference or to operation of the receiver at such high gain that inherent tube and circuit noises become noticeable.
- backlash** 1. Looseness or play in gears, such that one gear may be rotated an appreciable amount in the reverse direction without causing motion of other meshing gears. Backlash can be eliminated by using two gears side by side, coupled together with springs. 2. Imperfect rectification of alternating current by a thermionic tube, due to the presence of positive ions produced in the gas by collisions.
- back-shunt signaling** A method of keying a transmitter in which radio-frequency energy is fed to the antenna when the telegraph key is closed and to a nonradiating back-shunt circuit when the key is open.
- back wave** A signal heard from a radio telegraph transmitter when the sending key is open between active portions of the code characters or between messages, due to improper neutralization of the radio-frequency amplifier in the transmitter. Also called *spacing wave*.
- baffle** A cabinet or partition used with a loudspeaker to increase the effective length of the air path from the front to the rear of the moving diaphragm. By preventing interaction between sound waves produced simultaneously by the two surfaces of the diaphragm, a baffle improves the fidelity of reproduction and directs the sound waves in the desired forward direction.
- baffle plate** A metal plate inserted in a wave guide to reduce the cross-

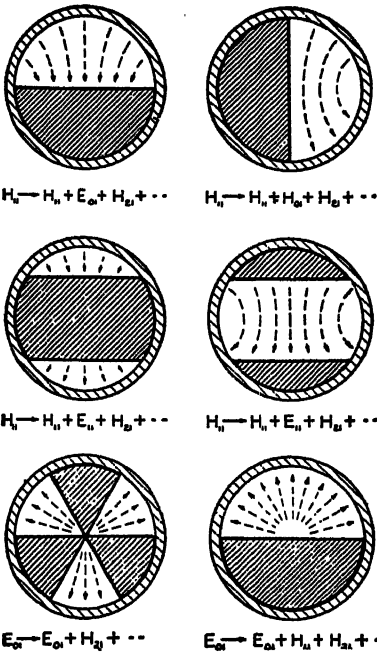

Typical metal baffle plates used as wave converters in circular wave guides. Arrows indicate incident and emergent waves. Formulas give predominant waves passed by each type of baffle.

sectional area for wave conversion purposes.

baffle-plate converter A wave converter consisting, in one form, of a semi-

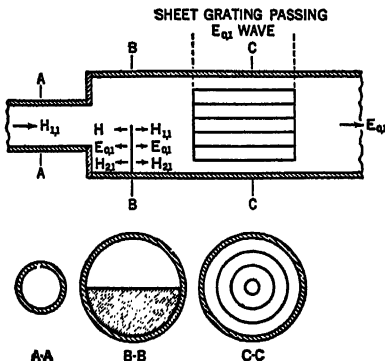

Baffle-plate converter inserted in a circular wave guide ahead of a coaxial sheet grating to convert $H_{1,1}$ wave into $E_{0,1}$ wave and vice versa. Cross sections are shown at the wave guide A-A, the baffle plate B-B, and the coaxial sheet grating C-C.

circular baffle just ahead of a sheet grating formed by a number of hollow coaxial cylinders. By proper choice of the type of baffle plate and sheet grating, any desired wave conversion can be achieved. The action of a baffle-plate converter is reversible

Bakelite A phenolic compound having good insulating qualities. Widely used in the construction of radio parts.

balance 1. In broadcasting, the proper blending of the different sounds that make up a radio program in order to give the desired artistic effect. 2. In television, the proper positioning of the various elements that make up a television scene in order to give the desired artistic effect.

balanced armature unit The driving unit used in some types of magnetic loudspeakers, consisting of an iron armature pivoted between the poles of a permanent magnet and surrounded by coils carrying the audio-frequency current. Variations in audio-frequency current cause corresponding changes in armature magnetism and corresponding movements of the armature with respect to the poles of the permanent magnet. Sound waves are produced by a diaphragm that is mechanically coupled to the moving armature.

balanced circuit A circuit having equal voltages and equal currents in corresponding parts of its main branches.

balanced three-wire system A three-wire system in which no current flows in the conductor connected to the neutral point of the supply.

balanced method Any method of measurement in which the reading is taken after the circuit has been balanced to bring the pointer of the indicating instrument to zero, as in a Wheatstone bridge or in a laboratory balance for weighing purposes. Also called *null method* or *zero method*.

balancer A circuit used in a radio direction finder to balance out the antenna effect due to capacitance between the loop and ground.

BALANCING MACHINE

balancing machine An apparatus for testing the mechanical balance of a rotating part of a machine in order to determine the magnitude and position of the balance weights required for correction or to determine the points at which material must be removed in order to provide perfect dynamic balance.

balancing network An electric network designed for use in a circuit in such a way that two branches of the circuit are made substantially conjugate.

ballast resistor A resistor that decreases in resistance when the current through it decreases, and increases in resistance when current increases, thereby maintaining essentially constant current despite variations in voltage. It is usually mounted in a glass envelope like a vacuum tube, and is used in some radio receivers to compensate for variations in line voltage. Not to be confused with line cord resistors and plug-in resistance tubes, which have no ballast action.

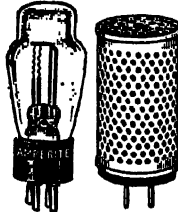

Ballast resistors.

ballast tube A ballast resistor mounted in an evacuated glass or metal envelope like that of a vacuum tube in order to reduce radiation of heat from the resistance element and thereby improve the voltage-regulating action.

ballistic galvanometer An instrument that indicates the effect of a sudden rush of electrical energy, such as the discharge current of a capacitor.

banana jack A jack that fits a banana plug. Generally designed for panel mounting.

banana plug A plug having a spring-metal tip somewhat resembling a

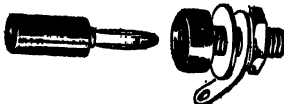

Banana plug and jack.

banana, used on test leads or as terminals for coils and other equipment.

band Frequencies within two definite limits. *Example:* The standard broadcast band extends between 550 and 1,600 kilocycles.

band-elimination filter A filter network that rejects a limited band of frequencies between an upper and a lower critical or cutoff frequency, while transmitting an entire range of frequencies on either side of this narrow band. In a suitable circuit, such a filter suppresses or eliminates the narrow band.

band-pass amplifier An amplifier designed to pass a definite band of frequencies with essentially uniform response. Frequently used in intermediate-frequency amplifiers of high-fidelity receivers.

band-pass filter A filter designed to pass currents at frequencies within a continuous band limited by an upper and a lower critical or cutoff frequency, while substantially reducing the amplitude of currents of all frequencies outside that band.

band-pass response

A response characteristic in which a definite band of frequencies is transmitted uniformly. In intermediate frequency transformers, it is obtained by tuning the primary and secondary resonant circuits to slightly different frequencies. Also called *flat-top response*.

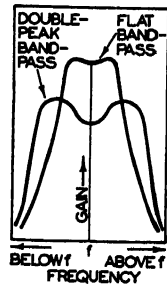

Typical band-pass response curves of intermediate-frequency amplifiers.

B & S Abbreviation for Brown and Sharpe wire gage, now known as American wire gage (AWG).

band selector A switch used to select any one of the bands in which a receiver or transmitter is designed to operate. Often called *band switch*.

BARKHAUSEN OSCILLATOR

bandspread Any method of spreading tuning indications over a greater scale range to simplify tuning in a crowded band of frequencies.

bandspread tuning control A separate tuning control provided on some short-wave receivers to spread stations in a single band of frequencies over an entire tuning dial. It controls small variable capacitors that are connected in parallel with each main tuning capacitor.

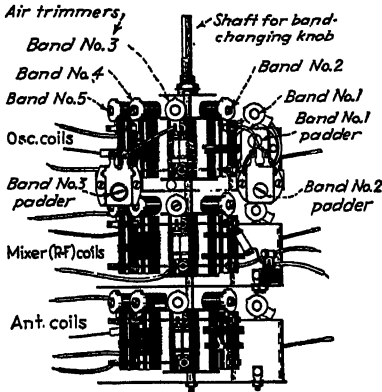

Coil-switching assembly for a five-band all-wave receiver.

band switch A rotary switch, usually having two or more sections, which simultaneously makes the required changes in connections of all tuning circuits in a receiver or transmitter to secure operation in a desired band of frequencies. Also called *band selector*.

bandwidth The number of cycles, or kilocycles, expressing the difference between the limiting frequencies of a frequency band. It can apply to any entity having frequency limits, as a tuned circuit, a combination of tuned circuits, a modulated radio signal, or a group of radio-station channel assignments.

bank A number of similar devices connected together and used as a single device. Examples are a bank of lamps serving as an artificial load, a bank of transformers, a bank of resistors, etc.

banked winding A method of winding radio-frequency coils in which single turns are wound one over the other in a flat outward spiral, with the entire coil consisting of many such spirals side by side in order to give a multi-layer coil without going back to the starting point. This construction reduces the distributed capacitance of the coil.

bantam jr. tube An extremely small vacuum tube with a glass envelope and special base. Used chiefly in hearing aids.

bantam tube A tube having a standard octal base but a considerably smaller glass tube than a standard glass tube. It is identified by the letters GT following the tube type number, and is usually equivalent electrically to the standard-size tube.

bar 1. The centimeter-gram-second absolute unit of pressure, equal to a pressure of one dyne per square centimeter. One million bars is equal to one megabar, a unit almost exactly equal to normal atmospheric pressure. Bar is sometimes written as barye. A certain amount of confusion exists regarding these units; hence radio engineers invariably use the full term dynes per square centimeter when specifying sound pressures. 2. A subdivision of a crystal slab, obtained by making two parallel saw cuts in planes perpendicular to the major surfaces of the slab.

barium An element sometimes used in the cathode coating of vacuum tubes.

Barkhausen effect The succession of abrupt changes in magnetization occurring when the magnetizing force acting on a piece of iron or other magnetic material is varied.

Barkhausen oscillator A type of triode oscillator in which radio frequencies ranging from 300 to 1,500 megacycles are generated, apparently by movements of filament electrons that initially overshoot the positive grid and pass back and forth through the grid before settling on it. The plate is at cathode potential or even slightly negative, and the grid is positive with

BAR MAGNET

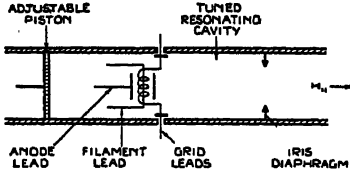

Simplified diagram of a Barkhausen oscillator built into circular wave guide to serve as a generator of $H_{1,1}$ waves.

respect to the cathode. The frequency is determined by the distance between the grid and plate and by the velocity of the electrons, and is independent of external tuning circuits.

bar magnet A bar of hard steel that has been strongly magnetized and holds its magnetism, thereby serving as a permanent magnet.

Barnett effect Magnetization produced by rotating a body, without applying a magnetic field.

barograph A recording barometer, and hence an instrument for recording changes in atmospheric pressure.

barometer An instrument for measuring the pressure of the atmosphere. Two common types are the aneroid barometer and the mercury barometer.

barostat A device used to maintain a constant pressure.

barretter 1. An early form of detector in which current impulses were measured or detected by the change in resistance produced by their heating effect in a fine wire. 2. British term for ballast resistor.

barrier-film rectifier A rectifier in which a film having unilateral (one-directional) conductivity is in contact with metal or other normally conducting plates. The copper-oxide rectifier is an example.

barrier layer The surface of contact between a metal and a semiconductor, which acts as a rectifier of alternating currents and, when illuminated, generates a voltage through photovoltaic action. The junction between the copper and cuprous oxide in a photonic cell is a barrier layer. Also called *blocking layer*.

barrier-layer cell A type of photovoltaic cell in which light acting on the surface of contact between layers of copper and cuprous oxide causes an electromotive force to be produced. Also called *blocking-layer cell* or *copper-oxide photovoltaic cell*.

barye Sometimes used for bar, the centimeter-gram-second absolute unit of pressure.

barytron An early name for the particle now known as *mesotron*.

base The number upon which a system of logarithms is constructed. The base of the common system of logarithms is 10, while that of natural logarithms is 2.718, usually designated as e . The base is designated to the right of and below the word log, as log₁₇; when no base is indicated, the base 10 is assumed.

base insulator A heavy-duty insulator used to support the weight of an antenna mast and insulate the mast from the ground or some other surface.

base-loaded antenna An antenna, usually vertical, having an inductance in series at or near the base for the purpose of loading the antenna so as to secure a desired electrical length with less height than would ordinarily be required.

base metal The material upon which a metal coating is deposited by electroplating.

basket winding A criss-cross coil winding in which adjacent turns are far apart except at points of crossing, resulting in low distributed capacitance.

bass Sounds corresponding to low audio frequencies.

bass-boosting circuit A circuit that attenuates higher audio frequencies in order to emphasize low or bass frequencies.

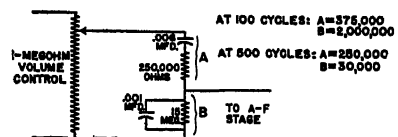

Bass-boosting circuit. A and B are in ohms.

bass compensation Any means for emphasizing the low-frequency response of an audio-frequency amplifier at low volume levels in order to offset the lowered sensitivity of the human ear to weak low frequencies.

bass control A manually adjusted control provided in a radio receiver or audio-frequency amplifier to attenuate higher audio frequencies and thereby emphasize bass notes. It may be a continuously variable control or a multiposition switch providing one or more degrees of bass boost.

bass response 1. The extent to which a loudspeaker or audio-frequency amplifier handles low audio frequencies. 2. The ability of any device to pick up or reproduce low audio frequencies.

bassy A term applied to sound reproduction that overemphasizes low-frequency notes.

bat-handle switch A toggle switch having an actuating lever shaped like a baseball bat.

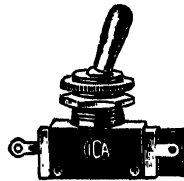

Bat-handle toggle switch.

bathub capacitor Popular name for a type of paper capacitor enclosed in a metal housing having broadly rounded corners like those on a bathtub.



Bathub capacitors.

battery A combination of two or more galvanic cells electrically connected to work together to produce electric energy. Common usage permits application of this term also to a single cell used independently.

battery acid In general, the sulphuric acid solution that serves as the electrolyte in a storage battery.

battery charger Any electrical device used for charging a storage battery. It may be a direct-current generator or

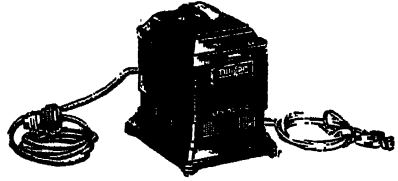

Battery charger using Tungar rectifier tube.

a rectifier unit that converts alternating current to direct current.

battery clip A metal clip having a screw terminal to which a connecting wire can be attached and spring jaws that can be quickly snapped on a battery terminal or other point to which a temporary connection is desired.



Battery clip.

battery receiver A radio receiver that obtains from batteries the voltages required by its vacuum tubes.

baud The unit of telegraph speed. Telegraph signals are characterized by intervals of time of duration equal to, or greater than the shortest or elementary interval. Telegraph speed is, therefore, expressed as the inverse of the value of the elementary interval in seconds. A speed of one elementary interval per second is termed one baud.

bay 1. One of the vertical compartments in which a radio transmitter or other equipment is housed. 2. A portion of an antenna array.

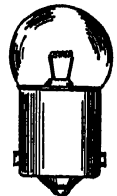

Bayonet-base pilot lamp.

bayonet base A vacuum-tube or lamp base having two projecting pins on opposite sides of a smooth cylindrical base, to engage in corresponding slots in a bayonet socket and hold the base firmly in the socket.

bayonet socket A socket for bayonet-base tubes or lamps, having J-shaped slots on opposite sides and one or more contact buttons at the bottom. Widely used for automobile lights, pilot lamps

BAZOOKA

in radio equipment, and regular electric lamps in Great Britain.

bazooka A device installed at the end of a coaxial transmission line to isolate the outer conductor from ground. Also known as a *line-balance converter*.

B battery The battery that furnishes the direct-current voltages required by the plate and screen-grid electrodes of vacuum tubes in a battery-operated circuit.

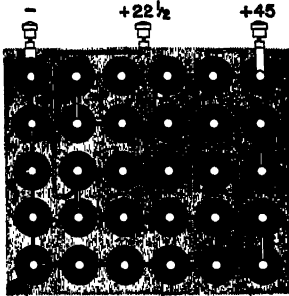

Internal connections of a standard 45-volt B battery.

BBC Abbreviation for British Broadcasting Corporation, a governmental agency that controls all broadcasting in Great Britain.

BC 1. Abbreviation for broadcast band.
2. Base shield connection, a designation used on base diagrams for GT type tubes.

BCL Abbreviation for broadcast listener.

bdi Abbreviation for bearing deviation indicator.

beacon A light, radio transmitter, or other signaling device that serves to indicate geographical location or direction to vessels or aircraft.

beacon course The equisignal zone created in the sky by an aircraft radio beacon to guide aircraft along charted courses regardless of weather conditions.

bead A glass or ceramic insulator with a hole through its center, used for insulating wires and for supporting the

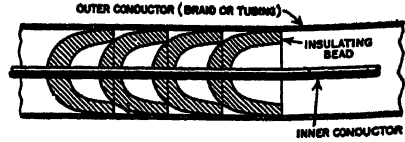

Bead-type coaxial line.

inner conductor of a coaxial line in the exact center of the line.

beam 1. The constant unidirectional radio signal that is transmitted by an aircraft radio beacon for guidance of aircraft. An aircraft flying exactly on the course indicated by a radio beam is said to be "flying the beam." 2. The angular range over which a microphone or loudspeaker gives maximum response.

beam angle The angle that encloses the greater part of the energy transmitted from or received by a directional antenna, loudspeaker, or microphone.

beam antenna An antenna that concentrates its radiation into a narrow beam in a definite direction.

beam current 1. The current carried by the electron stream that forms the beam in a cathode-ray tube. 2. The total anode current in a velocity-modulation tube. The actual current in the beam is smaller because focusing is never perfect.

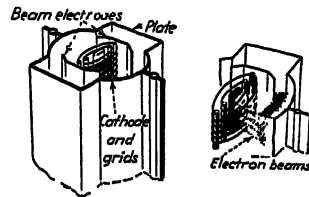

Beam electrodes in a beam-power amplifier tube.

beam-power amplifier tube A vacuum tube having special deflecting electrodes that concentrate the electrons into beams, giving high power output and other desirable characteristics. Widely used in output stages of radio receivers and audio-frequency amplifiers.

beam transmission Radio transmission concentrated into a beam by specially constructed directional antennas.

beam voltage The voltage between the cathode and the anode in a velocity-modulation tube. This voltage determines the average velocity of the electrons in the beam. Also called *acceleration voltage*.

bearing 1. The direction of one point with respect to another. 2. A support for a rotating shaft.

bearing deviation indicator One of the units in an underwater sound system, serving to indicate the direction of an arriving echo with relation to true north or to some major axis of the ship.

beat A complete cycle of the periodic variation of the amplitude of a quantity at a point, obtained in the phenomenon of beating due to the interference of two waves of different frequencies.

beat frequency One of the two additional frequencies obtained when signals of two different frequencies are combined. Their values are equal to the sum and difference, respectively, of the original frequencies.

beat-frequency oscillator An oscillator in which an audio frequency is obtained by mixing or beating together two radio-frequency signals.

beating Combining two different frequencies in order to produce a signal having a frequency equal to the sum or difference of the combined frequencies.

beat note The frequency produced by beating together two frequencies that differ in value.

beat reception The process of receiving radio waves by combining a received radio-frequency voltage with a locally generated alternating voltage to produce a beat frequency that is more readily amplified. This is done in a nonlinear circuit element, with the result that in the output there are frequencies equal to the sum and differ-

ence of the combining frequencies. If the received waves have constant amplitude and are continuous as in telegraphy, the locally generated frequency can be so chosen that the difference frequency is audible. When the received waves are modulated, the locally generated frequency is generally so chosen that the difference frequency is above audibility (at the intermediate-frequency value) and an additional operation is necessary before the original signal wave is reproduced. Also called *heterodyne reception*.

Becquerel effect The voltage obtained when two identical electrodes are immersed in an electrolyte and are unequally illuminated.

Becquerel rays Rays emitted by uranium salts and other radioactive materials, discovered by A. H. Becquerel. They have since been classified into beta and gamma rays.

bed The heavy metal casting on which the various parts of a high-quality sound recorder are mounted.

bel A unit named in honor of Alexander Graham Bell, used to express the relation between amounts of signal power and to express differences in sound-sonation levels. The number of bels is equal to the common logarithm of the ratio of the two powers or sound levels involved. Two powers or levels differ by 1 bel when their actual ratio is 10:1. A smaller unit called the decibel, equal to $\frac{1}{10}$ bel, is more commonly used. The neper is similar to the bel but is based upon Napierian logarithms.

B eliminator A power pack that changes alternating-current power-line voltage to the direct-current voltages required by vacuum tubes, eliminating the need for B batteries.

Bellini-Tosi direction finder An early type of radio direction finder that consists of two loop antennas at right angles to each other and connected to a goniometer. The bearing of an incoming signal is indicated by the goniometer, which compares the phase

BELL TRANSFORMER

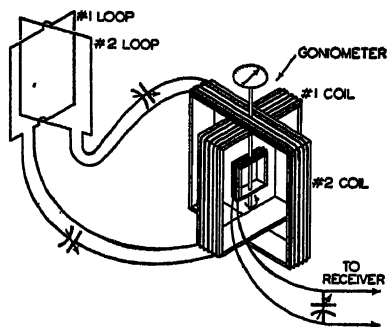

Simplified Bellini-Tosi radio direction-finder circuit.

relations of the currents induced in the two antennas by the incoming signal.

bell transformer A small iron-core transformer having a primary that connects to a 115-volt alternating-current line and a secondary that delivers 10 to 20 volts, for operation of a doorbell, buzzer, or chimes.

bell wire Cotton-covered copper wire, usually No. 18, used for doorbell and thermostat connections in homes and similar low-voltage work.

bent-shank needle A phonograph needle intended for use with heavy phonograph pickups because it lessens needle pressure on the record.

Bessel functions A number of mathematical powers in x that serve as solutions for the linear differential equation of the form

$$x^2 \frac{d^2y}{dx^2} + x \frac{dy}{dx} + (x^2 + a^2)y = 0.$$

beta Greek letter β , often used to designate angles or quantities.

beta particles Negatively charged particles each consisting of a single electron, projected in beta rays.

beta rays Electrons emitted from the atoms of an element that is undergoing radioactive transformation. These electrons come partly from the nucleus and partly from the outer electron orbits of the atom. They are more penetrating than alpha rays but less penetrating than gamma rays. They travel at speeds comparable with but

less than that of light, are easily deflected by a magnetic field, and affect photographic plates.

betatron The induction electron accelerator originally developed by D. W. Kerst. It speeds electrons just as a cyclotron speeds positive particles. Electrons emitted from the filament of a doughnut-shaped glass vacuum tube are accelerated in gradually contracting orbits by an alternating-current electromagnet and eventually strike a target, producing high-energy photons or X rays. Also called *induction accelerator* or *rheotron*.

between-the-lens shutter A shutter (light-blocking object) located between two of the lens elements of a camera. It usually consists of thin metal leaves that open and close or revolve to make the exposure or, in the case of a television camera, to permit the image to be projected on the television camera tube.

Beverage antenna A directional antenna consisting of a very long wire, supported a few feet above the ground.

bfo Abbreviation for beat-frequency oscillator.

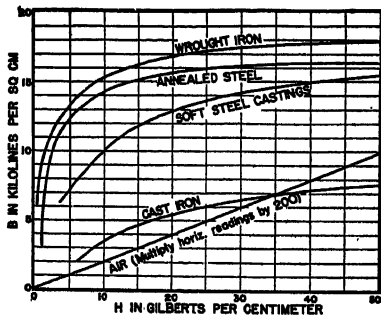

B-H curves for various materials.

B-H curve A characteristic curve showing the relation between magnetic induction B and magnetizing force H for a magnetic material. It shows the manner in which the permeability of a material varies with flux density. Also called *magnetization curve*.

BH rectifier A form of gas-filled cold-cathode rectifier tube.

bias The direct voltage used to make the control grid of a vacuum tube negative with respect to the cathode and provide the desired operating point. Also called *C bias* or *grid bias*.

bias cell A small dry cell used in the grid circuit of a vacuum tube to provide the required C bias voltage. It will last indefinitely if no current is drawn from it. Two sizes are available, producing 1 and $1\frac{1}{4}$ volts, respectively. Any number of cells may be used in series for higher voltages.

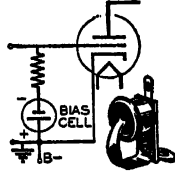

Bias cell and usage in typical circuit.

bias resistor The cathode resistor through which the plate and screen grid currents of a vacuum tube flow, developing across the resistor a direct voltage used as C bias for the tube.

biconical horn An arrangement of two conical horns with peaks facing each other, connected to a coaxial cable for the purpose of radiating microwave energy. The outer conductor of the cable is connected to one horn at its peak, and the inner conductor is connected to the other horn.

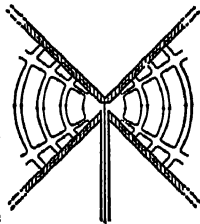

Biconical horn. Pattern of typical complementary wave.

bidirectional Responsive in two opposite directions. An ordinary loop antenna is bidirectional because it has maximum response from the two opposite directions that are in the plane of the loop.

bidirectional suspension A form of suspension used for the moving systems of galvanometers and similar highly sensitive instruments. It consists of two separate wires or fibers of quartz, in which raising of the center of gravity of the suspended system due to twisting of the wires out of the parallel position supplies practically the entire controlling force.

bifilar winding A method of winding noninductive resistors. The wire is first doubled on itself, then wound double, starting from the loop.

bilateral Having, or arranged upon, two sides.

bilateral antenna An antenna having maximum response in exactly opposite directions (180 degrees apart), such as a loop.

billion In the United States, a thousand million (1,000,000,000); in Great Britain, a million million (1,000,000,000,000).

bimetallic strip A strip formed of two dissimilar metals welded together. The metals have different temperature coefficients of expansion, causing the strip to bend or curl when the temperature changes. Used in thermostats and thermal time-delay switches.

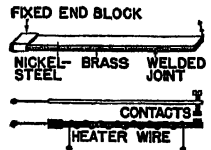

Bimetallic strip used as a time-delay switch.

bimorph cell Two crystal elements cemented together, used in crystal headphones, microphones, pickups, and loudspeakers. The elements are usually ground from Rochelle salt crystals.

binaural Duplicating the effect of hearing with two ears.

binaural effect That effect which makes it possible for a person to determine the direction from which a sound is coming. It is accomplished by distinguishing differences in arrival times of sound waves at the ears.

binder 1. The cementlike material used in carbon resistors for holding the carbon particles together and providing mechanical strength. 2. The resinous material used in phonograph records.

binding post A screw terminal used for making electrical connections.

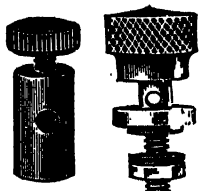

Binding posts.

BINOMIAL ARRAY

- binomial array** A directional antenna array that provides maximum response in two opposite directions. The array consists of a number of single-turn loops stacked vertically above each other, with all loops fed in phase, and with the current distributed between successive array elements according to a binomial expansion whereby the center radiators get more current than the outer ones.
- bioluminescence** Emission of light by living organisms, such as the firefly, certain fungi, and many marine forms.
- Biot-Savart's law** The magnetic intensity at any point near a current-carrying conductor can be computed on the assumption that each infinitesimal length of the conductor produces at the point an infinitesimal magnetic density. The resulting magnetic intensity at the point is the vector sum of the contributions of all the elements of the conductor. Also called *Ampère's law*, but these men did not state this law in its final differential form.
- bipolar** Having two poles.
- bipolar electrode** A conductive partition placed across an electrolytic cell so that one surface of the partition acts as an anode surface and the other as a cathode surface when an electric current is passed through the cell.
- bipolar magnetic driving unit** A head-phone or loudspeaker unit having two magnetic poles acting directly on a flexible iron diaphragm.
- birdie** A high-pitched whistle sometimes heard while tuning a receiver. It is due to beating between two radio frequencies differing by about 10,000 cycles per second.
- bisect** To cut or divide into two equal parts.
- bismuth spiral method** Measurement of magnetic flux by observing the change in resistance of a flat spiral of bismuth wire when placed in an air gap or elsewhere in the magnetic circuit. The resistance increases with increased strength of field.
- bivalent** Having a chemical valence of two.
- black** The signal produced at any point in a facsimile system by the scanning of a selected area of subject copy having maximum density.
- blackbody** A body whose radiant flux in all parts of the spectrum is the maximum obtainable from any body at that same uniform temperature. Such a radiator is called a blackbody because it will absorb all the radiant energy that falls upon it, and hence does not reflect radiant energy.
- blackening of a bulb** Formation of a black deposit on the inside of the glass of a thermionic vacuum tube or incandescent lamp after a period of use. It is due to particles of the filament being knocked off as the filament disintegrates owing to heat.
- blacker-than-black level** The direct voltage value used in an electronic television system for control impulses. It is greater than the value representing black portions of the image.
- black level** In television, the amplitude of the modulating signal corresponding to the scanning of a black area in the transmitted picture.
- black light** Invisible radiation. It may be either ultraviolet or infrared radiation, both of which are invisible. Black light is neither black nor is it light.
- blade** The flat moving conductor in a knife switch.
- blank** 1. The result of the final cutting operation on a natural crystal. 2. A recording blank.
- blanketing** Existence of an undesired signal so strong that it prevents reception of a desired radio signal.
- blanking pulse** The pulse used in television to remove the lines that would otherwise be traced each time the electron beam returns to start another line or frame. The application of a voltage for this purpose is called gating.

blasting Distortion due to overloading of any part of a radio transmitter, receiver, or public-address amplifier.

blattnerphone A device that records sounds as changes in magnetization along a steel wire or strip. Used in Great Britain for recording and reproducing broadcast programs and for sound-film production.

bleeder current Current drawn continuously from a power pack or other voltage source to lessen the effect of fluctuations in load current or to provide a voltage drop across some resistor.

bleeder resistance The value in ohms of a bleeder resistor.

bleeder resistor A resistor connected across a power pack or other voltage source to improve voltage regulation by drawing a fixed bleeder-current value continuously. Also used to dissipate the charge remaining in the filter capacitors when the unit is turned off.

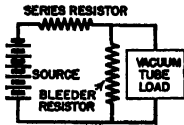

Use of a bleeder resistor across a load to reduce fluctuations in load voltage.

block diagram A diagram in which entire circuits, stages, or sections are represented by labeled blocks. Used in explaining general operating principles of radio and electronic equipment.

blocked-grid keying A method of keying a radiotelegraph transmitter in which sufficient grid bias is provided to block one or more tubes when the transmitting key is open. Closing the key removes this bias, applying full transmitter power to the antenna.

blocked impedance For an electro-acoustic transducer, the measured terminal impedance of its electric system when the attached mechanical system is blocked so that it cannot move and hence has infinite impedance. Also called *damped impedance*.

blocked resistance The resistance of a loudspeaker when its moving elements

are blocked so they cannot move. It represents the resistance due only to electrical losses.

blocking Applying a high negative bias to the grid of a tube to block its plate current.

blocking capacitor A capacitor used to block the flow of direct current while allowing alternating or signal currents to pass.

blocking layer The surface of contact between a metal and a semiconductor, which acts as a rectifier of alternating currents and, when illuminated, generates a voltage through photovoltaic action. The junction between the copper and cuprous oxide in a photonic cell is a blocking layer. Also called *barrier layer*.

blocking-layer cell A type of photovoltaic cell in which light, acting on the surface of contact between layers of copper and cuprous oxide, causes an electromotive force to be produced. Also called *barrier-layer cell* or *copper-oxide photovoltaic cell*.

blocking-layer rectifier A dry-disk rectifier, such as the copper-oxide rectifier.

blocking oscillator A form of oscillator in which a capacitor is charged through one impedance and discharged through another.

block signal A semaphore signal used in railroad control systems. It is operated by sensitive relays actuated by the current that flows when opposite rails are short-circuited by the wheels of a locomotive.

blooming A fuzzy effect in a reproduced television picture due to defocusing of the electron beam in the picture tube when excessively strong signals are applied to the electron gun.

blooper A receiver that is radiating a signal.

blow A fuse is commonly said to blow when it opens a circuit because of excess current, particularly when the current is heavy and the melting of the fuse is violent.

BLOWOUT MAGNET

blowout magnet A permanent magnet or electromagnet so positioned that it extinguishes the arc formed by the opening of a switch or relay. The magnetic field increases the length of the path of the arc.

blowtorch A portable device for producing the intense local heat required for soldering large objects or for heating large soldering irons.

blue glow A glow normally seen in electronic tubes containing mercury vapor. It is due to ionization of the molecules of mercury vapor. A blue glow near the electrodes of a vacuum tube means that the tube is gassy and hence defective. A soft blue fluorescent glow only on the glass of a vacuum tube is normal. A luminous blue glow exists near the cathode in a Geissler tube, especially when the tube contains air.

BMI Abbreviation for Broadcast Music, Inc., an association formed to license radio performances of the music of its members.

body capacitance Capacitance existing between the human body and a piece of electronic apparatus and between the human body and ground. Capable of detuning some radio circuits.

Bohr atom The atom as conceived by Bohr and Rutherford, consisting of a positive nucleus about which circulates a number of orbital electrons. Also called *Rutherford-Bohr atom*.

bolometer A highly sensitive thermometer utilizing changes in the resistance of a blackened platinum strip to measure thermal radiation, chiefly from stars.

Boltzmann's constant A constant equal to about 1.371×10^{-16} erg per degree. It is equal to the ideal gas constant divided by Avogadro's number.

bombardment 1. The process of directing high-speed electrons at an electrode, causing secondary emission of electrons, fluorescence, disintegration, or production of X rays. 2. The process of directing electrons or other high-speed particles at atoms to cause ionization or transmutation.

bonding 1. Connecting the metal parts of an automobile or airplane. 2. Connecting the shields of radio parts, or connecting these parts to the chassis.

book capacitor A two-plate trimmer capacitor having the plates hinged together like the pages of a book. The capacitance is varied by changing the angle between the plates.

boom A mechanical support for a microphone, used in a television or motion-picture studio to suspend a microphone within range of the actors but above the field of view of the camera.



Boom for supporting a microphone out of range of a television camera.

booster A small generator used in series or parallel with a larger generator to maintain normal voltage under heavy loads.

bound charge An early term for an induced charge that is still in the presence of the charge of opposite sign that induced it.

Bourdon gage A pressure-indicating gage that depends on deformation of a curved tube of elastic metal, of elliptic cross section, when pressure is applied to the interior of the tube by a liquid or gas.

B power supply The plate-voltage source for a vacuum tube. It may be a B battery, an alternating-current or universal power pack, a vibrator power pack, or a direct-current generator.

Bragg angle The glancing angle for X rays at the reflecting planes of a crystal. Used in X-ray orientation of quartz crystals being cut up for radio use.

Bragg's law The expression specifying the conditions under which a system of parallel atomic layers in a crystal will reflect a beam of X rays with

maximum intensity. If d is the distance between layers, θ is the glancing angle, λ is the wavelength of the X rays, and N is a whole number, the expression is $2d \sin \theta = N\lambda$.

branch A section of network between branch points or junctions.

branch points Junctions in a network at which current can divide.

Braun tube An early type of cathode-ray oscilloscope tube, requiring an operating potential of several thousand volts.

brazing Joining two metal objects by a process similar to soldering except that it uses an alloy, generally brass or hard solder, that is relatively infusible as compared with common solder.

breadboard construction Arrangement of all parts for a radio receiver or transmitter on a board, so that the parts may be anchored temporarily with wood screws and easily moved during experimental work.

breakdown A disruptive discharge through insulation, involving a sudden and large increase in current through the insulation due to complete failure under electrostatic stress. Also called *puncture*.

breakdown voltage The voltage at which insulation will break down and become conductive.

break-in keying A radio-transmitter keying method that permits the receiver to be operated continuously, so that the sending operator can receive incoming signals during keying intervals.

break-in operation A method of radio communication in which it is possible for the receiving operator to interrupt or break into the transmission at any time.

break-in relay A relay used in a radio transmitter for break-in operation, automatically permitting reception of incoming signals during keying intervals.

Brewster angle The angle of incidence at which a wave reflected from a surface undergoes a 90-degree phase shift with respect to the incident wave when the incident wave is polarized in the plane of the angle of incidence. The angle changes with frequency and with ground conditions.

bridge An instrument generally used for measuring an unknown value such as resistance, inductance, or capacitance by comparison with known values.

bridge circuit A test circuit consisting of four resistances or impedances all connected in series to form a diamond. A voltage source is connected between one pair of opposite junctions, and an indicating instrument (usually a galvanometer) is connected between the other pair of junctions. The unknown value is connected as one of the four elements, the other elements being adjusted until no current flows through the indicating meter or bridge. The value of the unknown can then be read on the dials of the instrument. The Wheatstone bridge is an example.

bridged T network

A T network in which the series impedances are bridged by a fourth impedance.

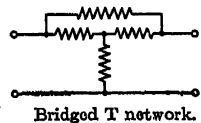

bridge rectifier A full-wave rectifier with four elements connected in series as in a bridge circuit. Alternating voltage is applied to one pair of opposite junctions, and direct voltage is obtained from the other pair of junctions.

bright level The zero-voltage level of the pulsating direct voltage constituting a television video signal. It represents white, the brightest part of the scene being televised.

brightness The luminous intensity of any surface in a given direction per unit of projected area of the surface as viewed from that direction. It is measured in candelas per unit area or in such brightness units as the lambert, foot-lambert, or stilb.

BRIGHTNESS CONTROL

brightness control The television-receiver control that varies the average brightness of the reproduced image.

brilliance 1. The degree of brightness and clarity in a reproduced television image. 2. The degree to which the higher audio frequencies sound like the original when reproduced by a receiver or public-address amplifier.

brilliance modulation Control of the brilliance of the trace on the screen of a cathode-ray tube in conformity with the signal. Also known as *intensity modulation*.

brilliance control The brightness control in a television receiver.

brilliant A term applied to sound reproduction in which high frequencies are properly reproduced.

Britannia splice A splice used for joining heavy wires, made by overlapping the bare ends of the wires and

wrapping a fine wire around the entire splice.

British Broadcasting Corporation The government-owned corporation in charge of all radio broadcasting in Great Britain. It is financed by license fees collected from each radio-receiver owner, and carries no commercial programs. Abbreviated BBC.

British thermal unit The quantity of heat required to raise the temperature of one pound of water one degree Fahrenheit. Abbreviated Btu. The corresponding metric unit is the calorie.

broad Responding to a wide range of frequencies. Usually applied to tuned circuits.

broadcast A radio transmission intended for public reception.

broadcast band The band of frequencies between 550 and 1,600 kilocycles in which are the carrier-frequency assign-

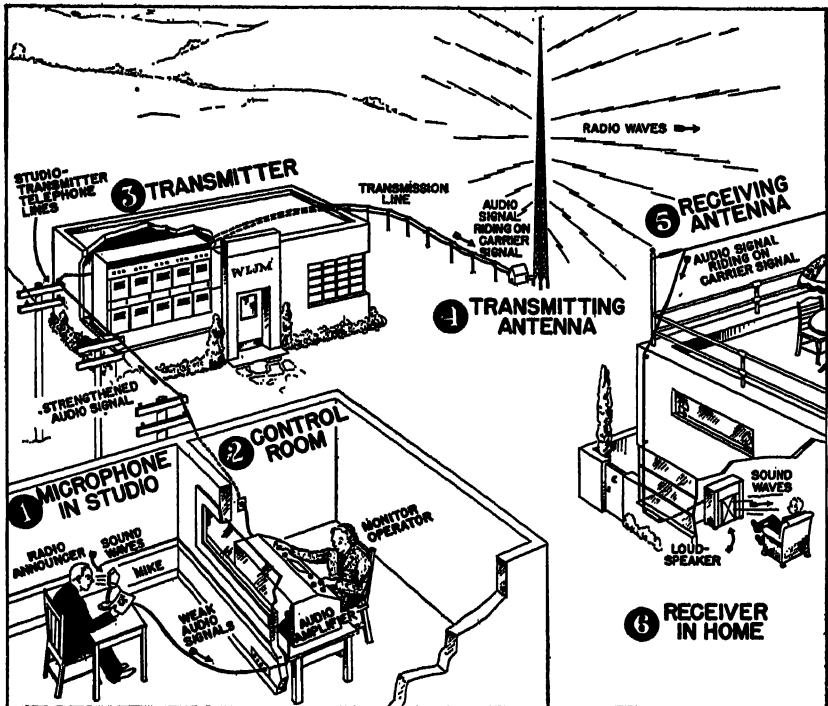

Complete broadcasting system, from microphone to receiver.

ments of all standard broadcast stations in the United States.

broadcast day The period of time between local sunrise and 12 midnight local standard time.

broadcaster One who or that which broadcasts a radio program for the benefit of an unlimited number of receiving stations.

broadcasting Transmission of radio programs intended for public interest, entertainment, or education.

broadcast station A radio station used for transmitting programs to the general public. This term usually applies only to stations in the 550- to 1,600-kilocycle broadcast band.

broadside array An antenna array in which the elements are in the same plane, with the currents of all elements in phase. The direction of maximum radiation is broadside to the plane containing the antennas.

broadside directional antenna A broadside array.

broad tuning A condition in which two or more radio stations are heard at a single setting of the tuning dial of a receiver, generally due to poor selectivity in the tuning circuits of the receiver.

Bronson resistance A high resistance consisting of two electrodes in a gas that is made conducting by a constant source of ionization.

bronze An alloy of copper and tin.

Brown and Sharpe gage Original name of the American wire gage (AWG) commonly used in the United States for specifying the size of a conductor. Wire sizes range from 0000 (0.46 inch diameter) for the largest to 40 and higher for the smallest diameters. Abbreviated B & S.

Brownian movement An erratic zigzag motion exhibited by very small particles in a liquid or gaseous medium, due to the thermal agitation of the molecules of the medium.

brush A metal or carbon block used to make contact with a rotating part,

such as the armature, of a generator or motor.

brush discharge A luminous electrical discharge consisting of visible streams of charged particles moving through the air between the terminals of a static machine or other high-frequency high-voltage source. It has a feathery appearance and is accompanied by a hissing sound.

brush holder The device, often adjustable, that holds a brush in the proper position against a commutator or slip ring and applies the correct pressure to the brush.

brute-force filter The common type of power-pack filter, depending on large values of capacitance and inductance to smooth out pulsations, rather than on resonant effects of tuned filters.

B supply The plate-voltage source for a vacuum tube. It may be a B battery, an alternating-current or universal power pack, a vibrator power pack, or a direct-current generator.

Btu Abbreviation for British thermal unit.

buck To oppose, as one voltage bucking another.

bucking coil A coil connected and positioned in such a way that its magnetic field opposes the magnetic field of another coil. The hum-bucking coil of an electrodynamic loudspeaker is an example.

bucking voltage An opposing voltage, having opposite polarity to that of another voltage against which it acts.

Buckley gage A type of ionization gage used for measuring very low gas pressures.

buckling In a storage battery, warping of the plates due to an excessively high rate of charge or discharge.

buffer A vacuum-tube stage used chiefly to prevent undesirable interaction between two other stages. In a transmitter, it generally follows the master-oscillator stage.

BUFFER AMPLIFIER

buffer amplifier A vacuum-tube amplifier used to separate the master-oscillator stage of a transmitter from following power-amplifier stages.

buffer capacitor A capacitor connected across the secondary of a vibrator transformer or between the anode and cathode of a cold-cathode rectifier tube to suppress voltage surges that might otherwise damage other parts in the circuit.

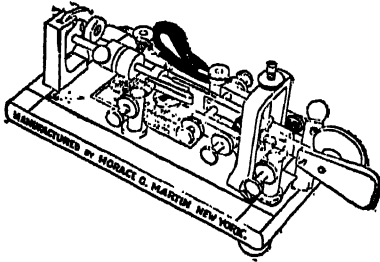

Code-sending bug.

bug 1. A ring dial used on echo ranging and radar equipment as a reference for reading the position of the projector or antenna with respect to the lubber line of a ship. Also used in connection with the bearing repeater compass card on the bearing deviation indicator of underwater sound equipment to indicate the true bearing of the projector. The compass card is electrically connected to the gyro compass on the ship. A bug is also used for a similar purpose on water or airborne radar equipment. 2. A semiautomatic code-sending key in which movement of a lever to one side produces a series of correctly spaced dots and movement to the other side produces a single dash.

building-out section A short section of transmission line, either open or short-circuited at the far end, shunted across another transmission line for use as an impedance-matching transformer.

building-up In a self-excited generator, the gradual increase in magnetic field strength from the residual-magnetism value to the normal operating value produced when normal field current is flowing. The residual magnetism pro-

duces the small initial voltage that starts the building-up process.

built-in antenna An antenna located inside the cabinet of a radio receiver. It is usually a loop, but may be simply a sheet of metal or a connection to the power line through a capacitor.

bulb A term loosely used to specify the glass envelope that encloses an incandescent lamp or an electronic tube. Sometimes applied to complete incandescent lamps.

buncher The buncher resonator in a velocity-modulation tube.

buncher resonator The first or input cavity resonator in a velocity-modulation tube. It serves to modify the velocity of the electrons in the beam.

buncher voltage The radio-frequency voltage between the grids of the buncher resonator in a velocity-modulation tube such as a klystron. In most discussions, the term implies the peak value of this oscillating voltage.

bunching The flow of electrons from the cathode to the anode as a succession of electron groups rather than as a continuous stream. Bunching may be effected by the control grid in an ultrahigh-frequency oscillator tube as the grid swings above and below the cutoff voltage during each cycle. Optimum bunching is the bunching condition required for maximum output. Underbunching and overbunching refer to the conditions existing when the buncher voltage is less or greater than the value required for optimum bunching. Ideal bunching theoretically gives a single infinite current pulse during each cycle.

bunching parameter A single term that combines the effect of a number of factors that determine the theoretical operation of a klystron.

Bunsen cell A primary cell having a zinc negative electrode immersed in sulphuric acid and a positive carbon electrode immersed in nitric acid, with the two liquids separated by a porous cup.

Bunsen photometer A photometer employing a spot of grease on a screen. The spot appears to vanish when both sides of the screen are equally illuminated. Also called *grease-spot photometer*.

burglar alarm An automatic electric signaling device intended to indicate attempted entry to protected premises.

burn out Failure of an electric motor, generator, heating element, or other appliance due to excessive heat produced by excessive current.

burst 1. A sudden increase in the strength of a signal being received from beyond line-of-sight range. It is believed due to meteors passing through the upper atmosphere and momentarily affecting the ionized layers that reflect radio waves back to earth. 2. A cosmic-ray effect upon matter, causing a sudden intense ionization that often gives rise to great numbers of ion pairs at once.

bus Term sometimes used to specify a busbar.

busbar A heavy copper strip or bar used on switchboards and in power plants to carry heavy currents.

bushing 1. A lining for a hole, intended to insulate and/or protect from abrasion one or more conductors that pass through it. 2. A metallic sleeve or lining, usually removable, inserted in a body and used as a bearing for a shaft in order to reduce friction.

butt The end of a mother quartz crystal opposite the pointed end or apex, generally broken off in the mining operation. The sides of the crystal taper inward slightly from the butt.

butterfly circuit A frequency-determining element having no sliding contacts, used in ultrahigh-frequency oscillator circuits to provide simultaneous change of both inductance and capacitance. It replaces conventional tuning capacitors and fixed coils. The shape of the rotor resembles the opened wings of a butterfly.

butt joint A splice or connection formed by placing the ends of two conductors together and joining them by welding, brazing, or soldering.

button The telescopic metal container that holds the carbon granules in a carbon microphone.

buzzer An electromagnetic device having an armature that vibrates rapidly, producing a buzzing sound.



BX cable.

BX cable Insulated wires in flexible metal tubing, used in wiring buildings or for bringing electric power to electric or electronic equipment. Often called simply BX.

bypass capacitor A capacitor connected to provide a low-impedance path for radio-frequency or audio-frequency currents around a circuit element.

C

- C** 1. Letter used to designate a capacitor on a diagram. 2. Chemical symbol for carbon. 3. Abbreviation for centigrade. 4. Letter used to designate the grid-voltage source for a vacuum tube. 5. Roman numeral for 100.
- C** Letter used to designate a capacitance in an equation.
- c** 1. Abbreviation for candle. 2. Abbreviation sometimes used for cycles per second. Better to spell out as cycles.
- C+** (C plus, or C positive) Denotes the positive terminal of the C battery or the positive polarity of some other grid-voltage source for a vacuum tube, or the grid-circuit terminal to which the positive source terminal should be connected.
- C-** (C minus, or C negative) Denotes the negative terminal of a C battery or the negative polarity of some other grid-voltage source for a vacuum tube, or the grid-circuit terminal to which the negative source terminal should be connected.
- C_{gk}** The grid-cathode capacitance in a vacuum tube.
- C_{gp}** The grid-plate capacitance in a vacuum tube.
- °C** Abbreviation for degrees centigrade.
- CAA** Abbreviation for Civil Aeronautics Authority.
- cabinet** The wood, plastic, or metal housing in which the chassis and loud-speaker of a radio or television receiver are mounted.
- cable** A stranded conductor (single-conductor cable) or a combination of conductors insulated from one another (multiple-conductor cable). The combination is sometimes encased in a lead sheath or covered with braided metal.
- cable count** The method used for determining the number of words in a cable message, in which every word of address, text, and signature is counted. Domestic count normally considers only words in the text.
- cactus needle** A playback point or phonograph needle made from the thorn of a cactus plant.
- cadmium** A silvery-white metal frequently plated on steel radio parts or on a steel chassis to prevent rusting.
- caesium** An alkali metal used in forming the cathodes of certain types of phototubes.
- caesium phototube** A phototube having a caesium-coated cathode. It has maximum sensitivity to the infrared portion of the spectrum.
- cage antenna** A group of parallel wires arranged in the form of a cylinder and connected together to serve as an antenna.
- cal** Abbreviation for calorie.
- calcium** An alkali metal used in forming the cathodes of certain types of phototubes.
- calibrate** To determine by measurement or comparison the correct value of each scale reading on a meter or other device being calibrated, or to determine the settings of a control which correspond to particular values of voltage, current, frequency, or some other characteristic.
- calibration** The process of determining the correct values for different positions of a meter, pointer, or settings of a control.
- call letters** Identifying letters, sometimes including numerals, assigned

to radio stations by the Federal Communications Commission or by corresponding authorities in other countries.

call signal The signal (usually call letters) used to identify a particular radio station during its operation.

calomel electrode A half cell containing a mercury electrode in contact with a solution of potassium chloride saturated with mercurous chloride. Also called *calomel half cell*.

calomel half cell Same as calomel electrode.

calorie The unit of heat energy in the metric system. The amount of heat required to raise the temperature of one gram of water from 15° centigrade to 16° centigrade. The corresponding unit is the Btu which is equal to 252 calories.

cam An irregularly shaped part used to convert rotary motion to linear motion, or vice versa. Used in mechanical pushbutton tuning systems.

cambric Linen or cotton fabric used for insulating purposes. Varnished cambric is impregnated with an insulating oil and baked, and when made in the form of tubing, it is called spaghetti.

camera A box or other housing in which the images of objects are projected on a light-sensitive surface. In ordinary cameras this surface is a film, while in television cameras it is the mosaic or other light-sensitive surface in the television camera tube.

camera signal The video output signal of a television camera.

camera tube A special vacuum tube that performs the two important functions of converting an optical image into a corresponding electrical image and selecting the picture elements in the proper sequence of alternate rows as required for interlaced transmission. Types of camera tubes in common use are the iconoscope developed by Radio Corporation of America, the image dissector tube developed by Farnsworth, and the

improved iconoscope known as the orthiconoscope.

Campbell-Colpitts bridge A shielded alternating-current bridge for measuring capacitance by a substitution method.

canal rays Streams of positively charged atoms or molecules (positive ions) that travel in the direction from the anode to the cathode in certain types of evacuated tubes. These rays are commonly observed in the space behind the cathode after passing through openings or canals in the cathode. More often called *positive rays*.

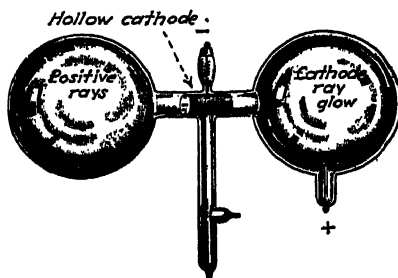

Canal-ray tube.

candelabra base A screw base for lamps having a size intermediate between that of a standard lamp and that of the miniature base used on flashlight bulbs.

candle The unit of luminous intensity. In the United States it is a specified fraction of the average horizontal candlepower of a group of 45 carbon-filament lamps preserved at the National Bureau of Standards, when the lamps are operated at specified voltages.

candle-hour A unit of light, or luminous energy, equal to the total luminous energy emitted in one hour by a source having a luminous intensity of one candle.

candlepower Luminous intensity expressed in candles and used to specify the strength of a light source.

Candohm A wire-wound resistor that is wrapped in heavy fiber insulating

CAPACITANCE



Candohm resistor.

paper and encased in metal. It is used chiefly as a voltage divider, and generally has one or more taps.

capacitance The electrical size of a capacitor, determining the amount of electrical energy that can be stored in it by a given voltage and the amount of alternating current that will flow at a given frequency. The basic unit of capacitance is the farad; it is the value that will pass a current of one ampere when the voltage across the capacitor is changing at the rate of one volt per second. The farad is too large a unit for radio or electrical work; hence the microfarad (one millionth of a farad) and the micro-microfarad (one millionth of a microfarad) are commonly used. Capacitance exists whenever two conductors are separated by an insulating material.

capacitance altimeter An electronic device for determining the exact height of an aircraft above ground when it is near the ground or preparing to land. It depends on changes in capacitance between two conductors on the aircraft when the ground, acting as a third conductor, is approached.

capacitance bridge A form of Wheatstone bridge used for making precise comparisons of capacitance values. It uses capacitors in some or all of its four elements, requires an alternating-voltage source, and utilizes a headphone in place of the usual galvanometer.

capacitance loading The tuning effect of a lumped capacitance at some point, usually the open-circuited end, of a transmission line.

capacitance-operated intrusion detector A boundary alarm system in which the approach of an intruder to an antenna wire encircling the protected area a few feet aboveground changes the antenna-ground capacitance and sets off the alarm.

capacitance meter An instrument used to measure capacitance values of capacitors or of circuits containing capacitance.

capacitance relay An electronic relay that responds to very small changes in capacitance such as that created by bringing a hand near the pickup wire or plate.

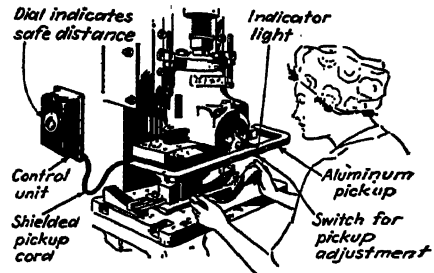

Capacitance relay arranged to shut off power to a punch press when the operator's hands come near the aluminum pickup bracket connected to the control unit.

capacitance section That part of a transmission line or resonator which may be considered as a lumped capacitance. The grids of a klystron resonator are the capacitance of the resonator.

capacitive coupling The linking of one circuit with another by means of capacitance that is common or mutual to both.

capacitive reactance That type of reactance which is due to the capacitance of a capacitor or circuit. Capacitive reactance is measured in ohms, designated by X_c , and is equal to the reciprocal of the product of 2π times the frequency in cycles per second and the capacitance in farads

$$X_c = \frac{1}{2\pi fC}$$

capacitor An electrical or radio device consisting essentially of two conducting surfaces separated by an insulating material or dielectric such as air, paper, mica, glass, or oil. A capacitor stores electrical energy, blocks the flow of direct current, and permits the flow of alternating current to a degree

CAPACITOR PICKUP

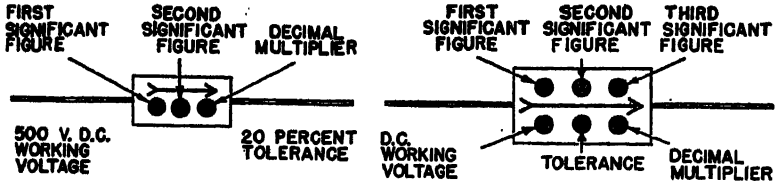

Color	Numerical	Volts	Multiplier	Tolerance, %
Black	0	1	
Brown	1	100	10	1
Red	2	200	100	2
Orange	3	300	1,000	3
Yellow	4	400	10,000	4
Green	5	500	100,000	5
Blue	6	600	1,000,000	6
Violet	7	700	10,000,000	7
Gray	8	800	100,000,000	8
White	9	900	1,000,000,000	9
Gold	..	1,000	0.1	5
Silver	..	2,000	0.01	10
No Color	..	500	20

Standard RMA color code for fixed capacitors. Capacitance values are in micromicrofarads. When only three colored dots are used, the direct-current working voltage is assumed to be 500 volts and the tolerance is assumed to be 20 per cent.

dependent on the capacitance and the frequency. The electrical size, or capacitance, of a capacitor is generally specified either in microfarads or micromicrofarads. A capacitor is often called a condenser, a term now deprecated.

capacitor antenna An antenna consisting of two conductors or systems of conductors, the capacitance between which is the essential characteristic.

capacitor bank A number of capacitors in a single container.

capacitor constant For a capacitor, the ratio of capacitive reactance to effective resistance at a given frequency.

capacitor loudspeaker A loudspeaker in which the mechanical forces result from electrostatic reactions between a

large flexible metal diaphragm and a rigid metal plate forming a two-plate air capacitor.

capacitor microphone A microphone, the electric output of which results from variation in electrostatic capacitance. It consists essentially of a flexible metal diaphragm and a rigid metal plate forming a two-plate air capacitor. Sound waves set the diaphragm in vibration, producing capacitance variations that are converted into audio-frequency signals by a suitable amplifier circuit.

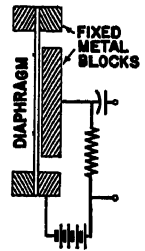
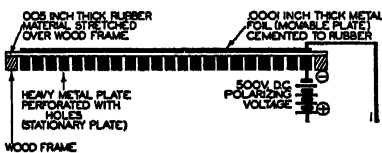

Diagram illustrating the operating principles of a capacitor microphone.

capacitor motor A single-phase induction motor having a main winding connected directly to a source of power and an auxiliary winding connected in series with a capacitor to the source of power.

capacitor pickup A phonograph pickup in which the electric output is gener-



Cross-section view of a capacitor loudspeaker.

CAPACITOR PLATES

ated by mechanical variation of its capacitance.

capacitor plates The half-round metal plates of a variable tuning capacitor, or the metal plates of any other capacitor.

capacitor shaft The shaft to which the rotor plates of a variable-tuning capacitor are attached.

capacitor split-phase motor Same as a capacitor-start motor.

capacitor-start motor

A split-phase induction motor having a capacitor connected in series with the auxiliary winding to aid in producing the rotating magnetic field required to bring the motor up to synchronous speed. The auxiliary circuit is opened, generally by a centrifugal switch, when the motor has attained a predetermined speed.

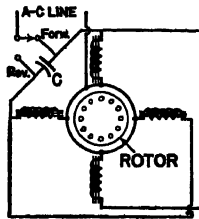

Simplified diagram of a capacitor split-phase induction motor (reversible).

capacity 1. Term often used for capacitance. 2. The rated load of a machine, apparatus, or device, or the maximum load that can be handled under existing service conditions.

capillary electrometer A sensitive electrometer in which a displacement of a drop of dilute acid in a column of mercury in a capillary tube is produced by the action of the voltage to be measured. The voltage changes the capillary forces due to surface tension and other factors.

carbon An element widely used in the construction of resistors, dry cells, and other radio and electrical parts.

carbon button A telescopic metallic container filled with carbon granules, used in carbon microphones.

carbon-contact pickup A phonograph pickup that depends for its operation on the variation in resistance of carbon contacts.

carbon filament An incandescent lamp filament consisting of a fiber or thread that has been reduced to carbon.

carbon granules Small carefully selected particles of carbon used in carbon microphones.

carbon microphone A type of microphone in which the flexible diaphragm applies a varying pressure to a container or button filled with carbon granules, causing the resistance of the microphone to vary in accordance with the varying pressure of sound waves on the diaphragm. A single-button carbon microphone has a carbon container on one side of the diaphragm only. A double-button carbon microphone has a carbon-filled container on each side of the diaphragm, and gives twice as much resistance change for a given diaphragm movement.

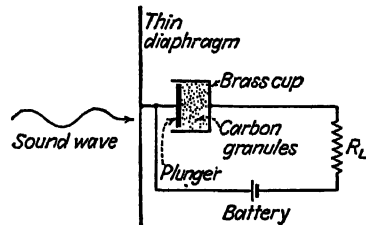

Circuit illustrating the action of a single-button carbon-granule transmitter as used in a telephone handset or a carbon microphone.

carbon-pile regulator A number of disks or blocks of carbon arranged in a pile, with a means for applying variable pressure to the pile in order to vary its total resistance and thereby regulate the current flowing in a circuit.

carbon-pile voltage regulator An automatic device employing variable pressure on a pile of carbon disks to vary the field circuit resistance of a generator in such a way as to keep the generator output voltage essentially constant.

carbon-pressure recording Electro-mechanical facsimile recording in which movement of a stylus or other pressure device over carbon paper produces the received image on a sheet of paper.

carbon regulator A variable resistance consisting of a number of carbon plates that can be subjected to varying mechanical pressure by a screw or other means. The greater the pressure, the lower is the resistance between the metal terminal plates at opposite ends of the stacks of carbon plates. Also called *carbon rheostat*.

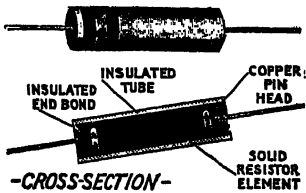

Carbon resistor—example and construction.

carbon resistor A resistor consisting of carbon particles mixed with a ceramic binder molded into a cylindrical shape and baked, with terminal leads attached to opposite ends. The unit is sometimes encased in a protective housing of plastic or some other insulating material.

carbon rheostat A carbon regulator.

carborundum A compound of carbon and silicon produced in crystal form in an electric furnace. It can be used as a crystal detector to rectify or detect radio waves.

carborundum detector A crystal detector employing carborundum crystals.

cardioid microphone A microphone having a heart-shaped response pattern that gives nearly uniform response for a range of about 180 degrees in one direction and minimum response in the opposite direction.

cardioid pattern A heart-shaped pattern obtained as the response or radiation characteristic of certain directional antennas or as the response characteristic of certain types of microphones.

cardiotachometer An electronic amplifier that times and records pulse surges. Used in determining pulse rates of the heart.

Carey-Foster bridge A type of Wheatstone bridge used to measure the difference between nearly equal resistances. Coils connected by a slide wire serve for two ratio arms.

carriage In a sound recorder having an overhead feed mechanism, the part that carries the cutting head.

carrier A term frequently used to designate a carrier current, carrier voltage, or carrier wave. When no sounds are being transmitted, as during a pause in a radio program, only the unmodulated carrier is present.

carrier current 1. The alternating current at the assigned carrier frequency of a radio station. It is capable of being modulated with an intelligence signal. 2. The radio-frequency carrier current sent over power, telegraph, or telephone lines for communication purposes. Carrier frequencies for telephone wires generally extend from about 5,000 to 30,000 cycles per second. Many additional circuits can be obtained from a single pair of wires by using carrier currents.

carrier frequency The frequency of the unmodulated radio wave produced by a radio transmitter or other source of modulated waves. For radio stations, it is assigned by the Federal Communications Commission or by corresponding authorities in other countries and must be maintained within a specified percentage of the assigned value.

carrier-frequency wire broadcasting A form of wire broadcasting in which a modulated current having a carrier frequency is either transmitted on special wire circuits or superimposed on telephone or power wires for distribution to a general listening audience.

carrier level The strength or level of an unmodulated carrier signal at a particular point in a radio system, expressed in decibels in relation to some reference level.

carrier repeater A repeater comprising one or more amplifiers and asso-

CARRIER SHIFT

ciated equipment for use in carrier transmission.

carrier shift A change, usually undesirable, in the carrier frequency of an amplitude-modulated radio transmitter.

carrier suppression Radio transmission in which the carrier wave is not transmitted.

carrier telegraphy That form of telegraphy in which, in order to form the transmitted signals, alternating current is supplied to the line after being modulated under the control of the transmitting apparatus.

carrier telephony That form of telephony in which carrier transmission is used, with the carrier wave being modulated by the voice-frequency wave. Ordinarily applied only to wire telephony. In most cases, the same carrier will be used for a number of different channels, with filter circuits to separate the messages that arrive simultaneously at the receiving end.

carrier transmission That form of electric transmission involving a wave resulting from the modulation of a single-frequency wave by a modulating wave.

carrier voltage The voltage of the unmodulated carrier signal.

carrier wave The unmodulated component of a radio wave, usually called simply the *carrier*. In effect, it carries the intelligence signal from a transmitting antenna through space to receiving antennas. It constitutes the entire output of a radio transmitter during those intervals when no intelligence is being transmitted.

carrying capacity The maximum current that a conductor can carry without becoming overheated and damaging its insulation.

cartridge fuse A fuse enclosed in an insulating tube in order to confine the arc and prevent it from damaging near-by objects when the fuse blows. The terminals are usually brass ferrules or blades at opposite ends on the tube.

cascade In series, as tuning circuits or amplifier stages used one after another.

cascade amplifier A vacuum-tube amplifier containing two or more stages arranged in the conventional series or cascade manner.

cascade connection A method of connecting similar pieces of apparatus so that the output side of one is connected to the input side of the next.

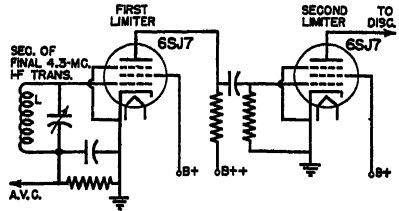

Circuit diagram of a two-tube cascade limiter for a frequency-modulated receiver.

cascade limiter A limiter circuit that uses two vacuum tubes in series or cascade, to give improved limiter operation in a frequency-modulated receiver for both weak and strong signals and provide considerably higher gain than is obtained with a single-stage limiter.

cascade tube A high-voltage vacuum tube used to produce hard X rays or high-speed ion beams. The total voltage is divided by constructing the tube in several sections connected in series or cascade.

cassette A holder for the film or plate and the intensifying screens of an X-ray machine.

catalyst Any substance used to aid a chemical reaction without causing any changes in its properties.

catcher The catcher resonator of a velocity-modulation tube.

catcher current The alternating-current component of the bunched beam current in a velocity-modulation tube. This current is not measured but is used in theoretical discussions as an indication of the output that may be expected. The product of the catcher current and the shunt impedance

CATHODE MODULATION

gives the radio-frequency voltage at the catcher grids.

catcher resonator The output resonator to which ultrahigh-frequency power is delivered in a velocity-modulation tube. The beam current between the grids of this resonator is pulsating or bunched, and when the resonator is tuned to the bunching frequency the beam delivers power to the catcher. This power is taken from the tube by means of small wire loops that lead to the coaxial terminals.

catelectrotonus The state of increased excitability of a nerve or muscle that is near the negative electrode or cathode during passage of direct current through living tissue.

catenary The curve assumed by a perfectly flexible and uniform chain or line hanging in equilibrium between two supports. Overhead telephone and power-line wires form catenaries.

cathautograph A system of transmitting visual writing, in which the writing is traced by an electron beam moving over the fluorescent screen of a cathode-ray tube, remaining visible there for a sufficiently long time to be read. The transmitter contains a stylus that regulates two resistances as in the telautograph and thus controls the deflecting fields for the cathode-ray tube in the receiver.

cathetron A grid-controlled mercury-vapor rectifier having an external control electrode.

cathode 1. The primary source of electrons in a vacuum tube. In thermionic vacuum tubes, the cathode is either heated indirectly by a filament or is itself a filament. The cathode is connected to the negative terminal of the plate-voltage source. 2. A general term for a negative electrode.

cathode bias See *cathode resistor*.

cathode current The total electron flow passing from the cathode to the other electrodes in a vacuum tube.

cathode dark space That portion of the glow discharge in a Crookes tube, length of neon tubing, or other dis-

charge tube that is between the cathode glow and the negative glow. It is nonluminous. Also known as *Crookes dark space*.

cathode disintegration The wearing away of a cathode in a vacuum tube by the bombardment of positive ions which knocks out atoms of cathode material. This action shortens the life of ordinary tubes, but is used to advantage in the process of sputtering a thin film of metal on a surface.

cathode drop The abrupt drop in voltage existing at the cathode surface of an electronic tube or electrolytic cell.

cathode follower A vacuum-tube circuit in which the output is taken between cathode and ground, giving high input impedance, low output impedance, and a gain of less than unity.

cathode-follower circuit A circuit in which the output load is included in the cathode circuit of a tube, and the input to the tube is applied between the grid and the remote end of the cathode load.

cathode glow A luminous glow immediately surrounding the cathode in a gaseous discharge tube at moderately low gas pressure.

cathode heating time The time in seconds required for the cathode of a thermionic vacuum tube to reach normal operating temperature after normal filament voltage is applied. The cathode is assumed to be at normal temperature when the plate current reaches 90 per cent of its final value.

cathode keying A transmitter keying method in which the direct-current circuits of both plate and grid in the keyed stage are opened simultaneously by breaking the plate return lead going to the cathode or filament center tap.

cathode-loaded amplifier A cathode-follower circuit connected so that gain is realized.

cathode modulation Amplitude modulation accomplished by varying simultaneously the plate and control grid voltages, thereby varying the cathode current.

CATHODE RAY

cathode ray A stream of electrons emitted from the cathode of an evacuated tube or from the ionized region near the cathode under the influence of an applied voltage.

cathode-ray current A current in a vacuum or in a rarefied gas, comprising the movement of electrons or other negatively charged subatomic particles.

cathode-ray direction finder A direction finder in which a visual indication of the bearing is automatically given by a cathode-ray tube.

cathode-ray furnace An experimental apparatus in which cathode rays from one or more concave electrodes are focused on the object to be heated in a vacuum. A sufficiently high temperature can be obtained to convert a diamond into black carbon.

cathode-ray lamp A vacuum tube in which cathode rays directed onto a block of lime or similar material produce sufficient heat to cause incandescence.

cathode-ray oscilloscope A test instrument using a cathode-ray tube to make visible on a fluorescent screen the wave forms of varying currents or voltages.

cathode-ray oscilloscope tube The cathode-ray tube used in an oscilloscope. Here the deflection of the electron beam by means of applied electric and/or magnetic fields indicates the instantaneous values of the applied voltages and/or currents.

cathode-ray television tube The cathode-ray tube used in a modern television receiver to reproduce the image being transmitted.

cathode-ray tube 1. A funnel-shaped vacuum tube having in its neck an electron gun that directs a beam of electrons at a fluorescent screen inside the large end of the tube. A glow is produced at the point where the beam strikes the screen. Electrostatic deflecting plates or electromagnetic deflecting coils are used to sweep the beam over the screen and make it trace thereon the waveform of a voltage or current or produce a pattern or com-

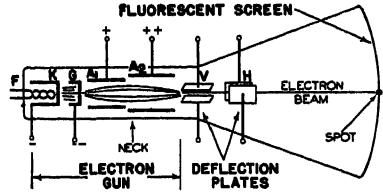

- F--FILAMENT--Pins 1 & 11
- K--CATHODE--Pin 12
- G--CONTROL GRID--Pin 10
- A₁--FIRST ANODE--Pin 4
- A₂--SECOND ANODE--Pin 7
- V--VERT. DEFL. PLATES--Pins 6 & 9
- H--HORIZ. DEFL. PLATES--Pins 3 & 8

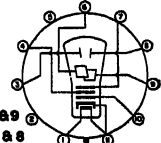

Construction and schematic symbols for a cathode-ray tube employing electrostatic deflection.

plete image. 2. A discharge tube having a thin window at the end opposite the cathode, through which cathode rays can pass into the atmosphere. Also called *Lenard tube*, and used in radiology.

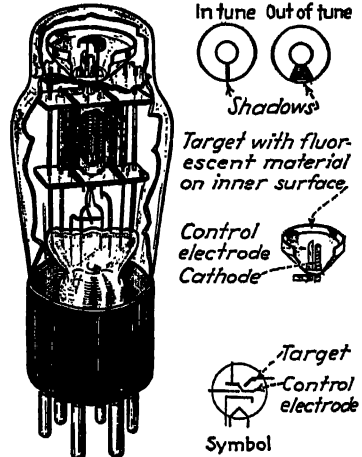

Diagram illustrating the construction of a cathode-ray tuning indicator tube.

cathode-ray tuning indicator A small cathode-ray tube, having about the same size and shape as an ordinary glass radio tube. Used in radio receivers to give a visual indication when the receiver is properly tuned.

cathode resistor A resistor used in the cathode circuit of a vacuum tube, and

C BIAS DETECTOR

having a resistance value such that the voltage drop across it, due to cathode current, provides the correct negative grid bias for the tube.

cathode spot The bright spot on the surface of the cathode of a pool-type mercury-vapor tube. Ionizing action is concentrated here, resulting in extremely high current density.

cathode sputtering An electronic method of depositing an extremely thin and uniform layer of metal on a surface. When used to produce the metal master of a phonograph record, the wax or lacquer original record is placed in a large demountable vacuum tube having a cathode operated under conditions that promote cathode bombardment resulting in sputtering of extremely small particles of molten metal. These fall uniformly on the record and produce thereon a conducting layer that can be strengthened by electroplating.

cathodoluminescence Luminescence excited by cathode rays.

cathodophosphorescence Phosphorescence excited by cathode rays.

catholyte The solution adjacent to the cathode in an electrolytic cell. The anolyte is adjacent to the anode.

cation A positive ion that moves toward the cathode in a discharge tube, electrolytic cell, or similar apparatus. The corresponding negative ion is called the anion.

catkin tube British term for a thermionic vacuum tube having a metal envelope that also forms the anode.

catwhisker A sharply pointed flexible wire used in a crystal detector to make contact with the surface of the crystal at a point that provides signal rectification.

caustic soda cell A cell in which the electrolyte consists primarily of a solution of sodium hydroxide.

cavity resonance A condition in which a baffle or cabinet for a loudspeaker has a natural resonant frequency in the range of audio frequencies it is han-

dling, causing unpleasant emphasis of sounds at that frequency.

cavity resonator A space totally enclosed by a metallic conductor and excited in such a way that it becomes a source of electromagnetic oscillations. The size and shape of the enclosure determine the resonant frequency. For a cylinder, the maximum resonant wavelength is 2.61 times the radius. Cavity resonators have an extremely high Q factor, which can be as great as 50,000. They are used in ultrahigh-frequency systems in place of conventional resonant circuits.

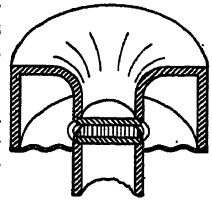

Cross-section of a typical cavity resonator, used in a klystron velocity-modulation tube.

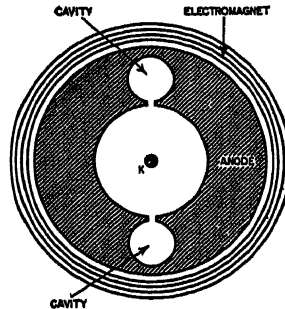

Cross-section of a cavity-resonator magnetron.

cavity-resonator wavemeter A resonating cavity used to determine the wavelength of microwaves.

C battery The battery that furnishes the steady voltage required by the control-grid electrodes of vacuum tubes in a battery-operated circuit.

C bias The direct voltage used to make the control grid of a vacuum tube negative with respect to the cathode and provide the desired operating point. Also called *grid bias*.

C bias detector A detector circuit in which the tube is operated with a C bias value almost negative enough to cut off plate current. Operation is thus at the lower bend of the grid

voltage-plate current characteristic curve, and detection takes place in the plate circuit.

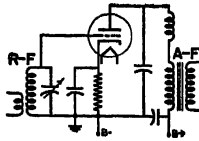

C bias detector circuit.

CBS Abbreviation for Columbia Broadcasting System.

cell 1. A single unit that produces a direct voltage by converting chemical energy into electrical energy. A dry cell is a primary cell, and cannot be recharged when exhausted. A storage cell is a secondary cell, and can be recharged by passing current through it in the reverse direction. 2. A single unit that produces a direct voltage by converting radiant energy into electrical energy, as a photovoltaic cell. 3. A single unit that produces a varying voltage drop because its resistance varies with illumination, as in selenium cells and phototubes (originally called photoelectric cells).

cellulose acetate A thermoplastic material available in a wide range of colors and forms, possessing toughness, resilience, resistance to sunlight, and resistance to fire. Used for radio cabinets, instrument lenses, etc.

cellulose nitrate disk A phonograph record made from cellulose nitrate.

Celotex A building material made by compressing the fibers of shredded sugar cane into sheets. It is used extensively in acoustic treatment of radio and television studios and in theaters and auditoriums for echo prevention because of its high sound-absorption factor.

cemf Abbreviation for counter electromotive force.

cent An interval equal to 1/1,200 octave, and hence equal to 1/1,200th of the interval of two frequencies having a ratio of 2:1.

center frequency The assigned carrier frequency of a frequency-modulation station. It is radiated only during intervals of silence during programs; at other times, the transmitter fre-

quency swings above and below the resting-frequency value at a rate corresponding to the sound frequency being transmitted. Also called *resting frequency*.

centering control A control, either the horizontal centering control or the vertical centering control, provided in a television receiver or a cathode-ray oscilloscope to shift the position of the entire image on the screen.

center tap A terminal at the electrical midpoint of a resistor or other device.



Center-tapped resistor.

center-tap keying A method of keying a radiotelegraph transmitter by interrupting the current in the plate return lead going to the filament center tap. Also called *cathode keying*.

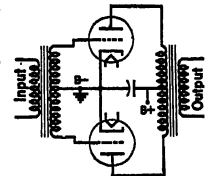

Use of center-tapped transformers in a push-pull amplifier output stage.

centi- A prefix meaning a hundredth of.

centigrade The metric temperature scale, in which the interval between the freezing and boiling points of water is divided into 100 equal parts or degrees, with 0° as the freezing point and 100° as the boiling point. Absolute zero is -273.1°C. To change degrees centigrade to degrees Fahrenheit, multiply by 9/5 and add 32 to the result.

centimeter 1. A unit of length in the metric system, equal to 0.01 meter, or 0.394 inch. A centimeter of mercury is the pressure per unit area exerted by a column of mercury 1 centimeter high. 2. More rarely the centimeter-gram-second electrostatic unit of capacitance. It is then the capacitance of an isolated metal ball having a radius of 1 centimeter and is equal to about 1.113 micromicrofarads.

centimeter-gram-second system See *cgs system*.

central station A main power generating station, as distinguished from smaller outlying substations.

CGS ELECTROMAGNETIC SYSTEM

centrifugal switch A switch that is opened or closed by centrifugal force. It is used on some induction motors to open the starting winding when the motor has almost reached synchronous speed.

ceramic Pertaining to articles made from earth by the agency of fire.

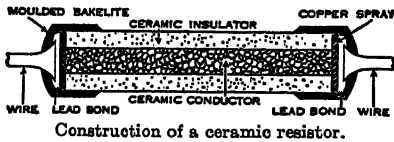

Construction of a ceramic resistor.

ceramic bead A doughnut-shaped bead made from ceramic material and used to insulate and support a wire in the exact center of a metal tube serving as a coaxial cable.

connections are made to opposite sides of the disk. In both types, the silver is applied as a coating on the baked ceramic.

cgs Abbreviation for centimeter-gram-second, the metric units of length, mass, and time.

cgs electromagnetic system An absolute system for measuring electrical and magnetic quantities. It is based on the centimeter-gram-second system of units, on the assignment of the value of unity to the strength of each of two magnetic poles that repel each other in a vacuum with a force of 1 dyne at a distance of 1 centimeter, on the measurement of current by means of its magnetic effect, and on the measure-

Color	End color	1st dot	2nd dot	3rd dot	4th dot	
	Temperature coefficient, $\mu\mu\text{f}$ per $\mu\mu\text{f}$ per $^{\circ}\text{C}$.	First significant figure	Second significant figure	Multiplier	Tolerance	
					For units over 10 $\mu\mu\text{f}$, per cent.	For units 10 $\mu\mu\text{f}$ or smaller
Black	Zero ± 0.00008	0	0	1	± 20	12.0 $\mu\mu\text{f}$
Brown	-0.00008 or -30×10^{-6}	1	1	10	± 1	10.1 $\mu\mu\text{f}$
Red	-0.00008 or -80×10^{-6}	2	2	100	± 2	10.2 $\mu\mu\text{f}$
Orange	-0.00015 or -150×10^{-6}	3	3	1,000	± 2.5	10.25 $\mu\mu\text{f}$
Yellow	-0.00022 or -220×10^{-6}	4	4			
Green	-0.00033 or -330×10^{-6}	5	5	± 5	10.5 $\mu\mu\text{f}$
Blue	-0.00047 or -470×10^{-6}	6	6			
Violet	-0.00075 or -750×10^{-6}	7	7			
Gray	8	8	0.01		
White	Not specified	9	9	0.1	± 10	11.0 $\mu\mu\text{f}$

Color code arrangement for tubular ceramic capacitors. *Example:* Violet end, followed by dots or bands of orange, green, brown, and white indicates a 350-micromicrofarad capacitor with 10 per cent tolerance and a temperature coefficient of -0.00075 micromicrofarad per micromicrofarad per degree centigrade. (Color bands are used in place of dots on some units.)

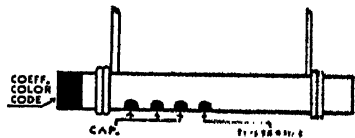

ceramic capacitor A capacitor in which the dielectric material is a ceramic, the composition of which can be controlled to give a wide range of temperature coefficients, both positive and negative. A tubular type consists of two silver coaxial cylinders separated by the ceramic dielectric. A feed-through type employs an insulating ceramic disk in which the

ment of potential difference as the quotient of power divided by current. This system has been more widely used than any other system of units. Electrical units employed in the system are frequently designated by the prefix *ab* attached to the units of the practical system. Names for some of the magnetic units, such as the *ab* and *gilbert*, were adopted by the Inter-

CGS ELECTROSTATIC SYSTEM

national Electrotechnical Commission in 1930.

cgs electrostatic system An absolute system of units for measuring electric and magnetic quantities. It is based on the centimeter-gram-second system of units, plus assigning the value of unity to the dielectric constant of a vacuum and measuring electric energy in mechanical units.

cgs system An absolute system of units for measuring physical quantities, based upon the centimeter, gram, and second as fundamental units. This system is primarily applicable only to mechanical units, but has been extended to other fields by accepting the doctrine of conservation of energy and by introducing a fourth unit or a property of a material, as in the cgs electrostatic system and cgs electromagnetic system.

CH Designation often used on diagrams to identify an iron-core choke coil. A radio-frequency choke coil is sometimes marked RFC.

chain A network of radio or television stations connected by special telephone lines, by coaxial cables, or by radio relay links so that all can simultaneously broadcast a program originating at a key station.

changeover switch A switch used in a radio communication station to change the antenna connection from the receiver to the transmitter, or vice versa.

channel 1. A band of frequencies including the assigned carrier frequency within which a radio station must maintain its modulated carrier signal to prevent interference with stations on adjacent channels. 2. One branch or path over which signals may travel. A public-address system may have several input channels, each with its own microphone, transmission line, and volume control. 3. Any circuit over which telephone, telegraph, or other signals may be sent by carrier-current methods.

channeling A special case of multiplex transmission in which a modulation-frequency band is utilized for simul-

taneous transmission from two or more communication channels. Separation between the channels is accomplished by the use of carriers or subcarriers, each in a different frequency band forming a subdivision of the main band.

characteristic conductivity The percentage increase in the current of a photoelectric cell per volt increase in applied voltage, for constant illumination.

characteristic curve A curve plotted on graph paper to show the relation between two changing values, as the effect of a change in grid voltage on the plate current of a vacuum tube.

characteristic impedance For a uniform line of infinite length, the ratio of an applied voltage to the resultant current at the point where the voltage is applied. It is thus the impedance in ohms measured between the terminals of the transmission line at the operating frequency. Also called *surge impedance*, and designated in equations as Z_0 . For nonuniform lines or structures, the recommended corresponding term is iterative impedance.

characteristic radiation X rays of a particular frequency, emitted as secondary radiation by a substance being bombarded by X rays having sufficiently high frequency. The square roots of the frequencies of the secondary rays given out by the elements form a series corresponding to their atomic numbers.

characteristic roentgen rays Roentgen rays (X rays) having wavelengths determined by the atomic constitution of the object that emits them.

charge 1. The electrical energy stored in a capacitor or held on an insulated object. An object having more electrons than normal has a negative charge. An object having fewer electrons than normal has a positive charge. 2. To furnish electrical energy to a capacitor, insulated metal object, or storage battery.

charger A device used to convert alternating current into a pulsating direct current suitable for charging a storage battery.

CHRISTMAS-TREE PATTERN

charge-resistance furnace A resistance furnace in which the heat is developed within the charge acting as the resistor.

charging current 1. The current flowing into a capacitor when a voltage is applied. 2. A current flowing in the correct direction to charge a storage battery. 3. The correct current value at which a particular storage battery should be charged.

charging rate The rate in amperes at which a storage battery is charged.

charging voltage The voltage required to send the correct charging current through a storage battery.

chart 1. The paper or other material upon which the graphic record is made by a recording instrument. 2. A presentation of information in tabular form on paper or other material. 3. A map showing some geographical aspect, as a route or magnetic variations, usually by curves, of fluctuations in a variable quantity, such as the height of the Heaviside layer or the intensity of the earth's magnetic field.

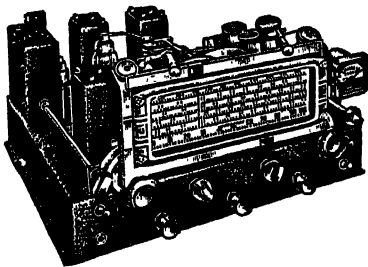

Chassis of communications receiver.

chassis The metal frame on which the parts of a radio receiver, transmitter, or other electronic unit are mounted.

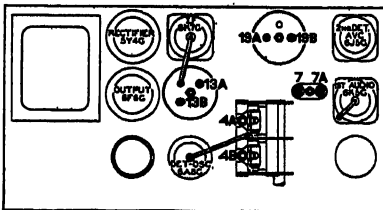

Chassis layout for a typical six-tube alternating-current superheterodyne receiver.

chassis base See *chassis*.

chassis units Plural expression for *chassis*.

chatter Vibration of a cutting stylus in a direction other than that in which it is driven.

check beam A radio beam indicating exact position to pilots preparing to level off for a landing at an airport.

chemiluminescence Luminescence produced by chemical action, such as the emission of light due to the slow oxidation of phosphorus at ordinary temperatures.

chip The material removed from a phonograph disk by the recording stylus during sound recording. Also called *thread*.

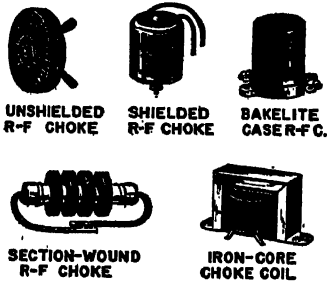

Choke coils (inductors).

choke coil An inductor used to limit or suppress alternating current without appreciably affecting the flow of direct current. Also called *impedance coil*.

chopper A device for interrupting a current or ray of light at frequent and regular intervals.

chopping The removal, by electronic means, of one or both extremities of a wave form at a predetermined level.

c-hr Abbreviation for candle-hour.

Christmas-tree pattern The optical pattern observed when the surface of a phonograph record is illuminated by a beam of light that is essentially parallel to the surface of the record. The frequency response of the recording can be determined by inspection of this pattern.

CHROMATIC ABERRATION

chromatic aberration An aberration (lens defect) that affects the sharpness of optical images. Different colors of light passing through a lens produce different magnifications, and different colors come to a focus at different distances from the lens. The focus for red light will be farther away from the lens than that for violet light, and there will be colored fringes around the image. Chromatic aberration is corrected by combining a crown-glass lens with a flint-glass lens, giving what is known as an achromatic lens. All anastigmatic lenses are corrected for chromatic aberration.

chronograph Electric apparatus for recording intervals of time with a high degree of accuracy. It usually operates by closing contacts so as to send current impulses to energize electromagnets that make a recording pen trace indications on a paper strip traveling at a known speed.

chronopher A contact maker used to send impulses over a line from an observatory or a standard clock to serve as standard time signals.

chronoscope An electronic interval timer originally developed to measure the velocity of rifle bullets. It employs two thystrons to pass a known current through a ballistic galvanometer during the time interval to be measured.

chuck The clamping device that holds the stylus or needle of a phonograph pickup.

cipher 1. The numeral zero. 2. A code for transmitting messages.

circle cutter A tool used for cutting large circular holes in panels for electronic equipment.

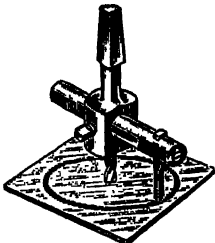

Circle cutter.

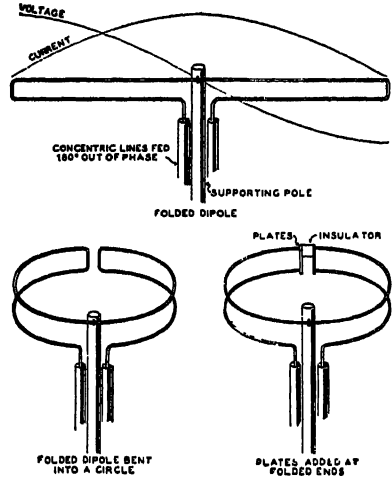

Evolution of a circular antenna from a folded dipole.

circle diagram A circular diagram showing the properties of induction motors and other alternating-current equipment.

circuit A complete path over which electrons can flow from the negative terminal of a voltage source through parts and wires to the positive terminal of the same voltage source.

circuit breaker An electromagnetic device that opens a circuit automatically when the current rises in excess of a predetermined value. It can be reset by operating a lever or by other means.

circuit-disturbance test A method of isolating a defective stage in a radio receiver. Starting from the loudspeaker and working back toward the antenna, a disturbance is introduced in each stage by removing and replacing the tube, touching the top cap, removing and replacing the top clip, or shorting the grid momentarily to the cathode or chassis. The first stage at which this disturbance fails to produce a click, howl, or other indication in the loudspeaker may indicate that this stage is defective.

circuit noise Noise that is brought to the loudspeaker of a radio system or to the receiver of a telephone system by electrical means.

circular antenna A horizontally polarized antenna derived essentially from a half-wave antenna by bending the elements around a circular shape. It radiates substantially uniform energy in all directions horizontally, with low vertical radiation, and may readily be mounted on a single pole.

circular electric wave Any wave with circular electric lines of force.

circular grating A conformal wire grating consisting of concentric wire rings mounted on insulating cross bars in a circular frame that fits inside a circular wave guide. A circular grating obstructs H waves (TE waves) of zero order while passing the corresponding E waves (TM waves).

circular guide A metal tube having a circular cross-section and serving as a wave guide for propagation of electromagnetic waves through its interior at frequencies of 1,000 megacycles and higher. The H wave of first order and first mode (H_{11}) has the lowest attenuation for practical purposes in circular wave guides.

circularly polarized wave An elliptically polarized wave in which the displacement at any point rotates about the point with constant angular velocity and has a constant magnitude.

circular magnetic wave Any wave with circular magnetic lines of force.

circular mil A unit of area equal to the area of a circle whose diameter is 1 mil (0.001 inch). Used chiefly in specifying cross-sectional areas of round conductors.

circular mil foot A unit conductor having a cross-sectional area of one circular mil and a length of one foot. Used for comparing resistances of wires made from different materials. The specific resistance of a material is the resistance in ohms of one circular mil foot of the material.

circular polarization Polarization in which the end of the rotating vector representing the vibrations in a beam of polarized radiation traces a circle during each polarization cycle.

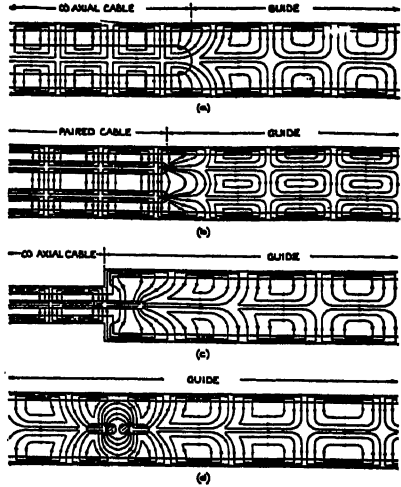

Four methods of feeding circular wave guides, with resulting distribution of electric forces in axial planes. (a) $H_{0,1}$ wave is launched from a coaxial cable; (b) $H_{1,1}$ wave is launched from a paired cable; (c) $H_{0,1}$ wave is launched from a straight-wire antenna fed from a coaxial cable; (d) $H_{0,1}$ wave is launched from a dipole fed by a pair of Lecher wires (top view of dipole is shown).

circular wave guide A wave guide whose cross-sectional area is circular.

cir mil Abbreviation for circular mil.

cir mils Abbreviation for circular mils.

civil air patrol station A radio station exclusively for essential communications relating directly to the activities of the Civil Air Patrol.

civilian defense station A radio station operated by a municipal government for emergency communication relating directly to the activities of the United States Citizens' Defense Corps or other equivalent officially recognized organizations.

clamping circuit A circuit in which either amplitude extreme of a waveform is maintained at a certain potential level.

Clark cell A standard cell used in voltage measurements, having a positive electrode of mercury, a negative electrode of zinc amalgam, and an electrolyte of zinc sulphate. Its voltage is 1.434 volts at 15° centigrade.

CLASS A AMPLIFIER

class A amplifier A vacuum-tube amplifier in which plate current flows at all times and the amplification is essentially linear. The grid voltage is chosen to place the operating point in such a way that the input signal voltage will swing over a straight portion of the tube characteristic curve at all times but will never swing positive and will never swing down to the curved portion near cutoff.

class AB amplifier A vacuum-tube amplifier in which plate current flows for appreciably more than one-half of each input cycle but not for the full cycle. The operating point is essentially the same as in a class A amplifier, but the signal voltage is allowed to swing positive and beyond cutoff to give increased operating efficiency. The input circuits are especially designed to eliminate the resulting distortion.

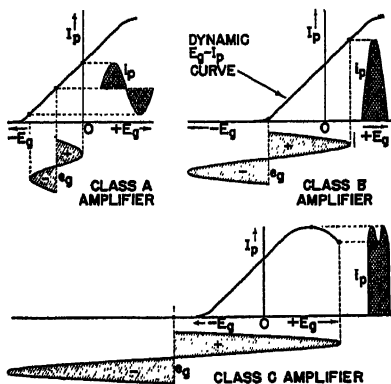

Three basic types of amplifier operation.

class B amplifier A vacuum-tube amplifier in which the grid bias is approximately equal to the cutoff value of the tube, so that plate current is essentially zero when there is no input signal. Plate current then flows for approximately one-half of each input signal cycle, and the grid is generally allowed to swing positive on peaks. Class B operation is used in both radio-frequency and audio-frequency amplifiers, generally in push-pull stages to minimize distortion.

class C amplifier A vacuum-tube amplifier in which the grid bias is greater

than the cutoff bias, so that plate current is zero for no signal and flows for appreciably less than one-half of each input signal cycle. The grid may swing positive far beyond saturation. Used chiefly for radio-frequency stages in radio transmitters.

class I station A dominant standard broadcast station that operates on a clear channel and is designed to render primary and secondary service over an extended area and at relatively long distances. The operating power is not less than 10 kilowatts nor more than 50 kilowatts.

class II station A secondary standard broadcast station that operates on a clear channel and is designed to render service over a primary service area that is limited by and subject to such interference as may be received from class I stations. The operating power is not less than 0.25 kilowatt nor more than 50 kilowatts. Whenever necessary, a class II station uses a directional antenna or other means to avoid interference with class I stations and with other class II stations.

class III station A standard broadcast station that operates on a regional channel and is designed to render service primarily to a metropolitan district and the rural area contiguous thereto. A class III-A station operates with a power of not less than 1 kilowatt nor more than 5 kilowatts. A class III-B station operates with a power of not less than 0.5 kilowatt nor more than 1 kilowatt at night and 5 kilowatts during the daytime.

class IV station A standard broadcast station that operates on a local channel and is designed to render service primarily to a city or town and the suburban and rural areas contiguous thereto. The operating power is not less than 0.1 kilowatt nor more than 0.25 kilowatt.

cleanup The gradual disappearance of gases from a discharge tube during its operation, or from other electronic tubes when the getter is vaporized by induction heating.

clear To remove all temporary connections from a switchboard, or to restore electrical conditions to normal.

clearance 1. The distance between two terminals or conductors having opposite polarity, or between a conductor and objects at ground potential. 2. Space between a moving and stationary object. 3. Permission from the owner of a musical copyright to broadcast a particular musical number.

clear channel A standard broadcast channel in which the dominant station or stations render service over wide areas. Stations on a clear channel are cleared of objectionable interference within their primary service areas and over all or a substantial portion of their secondary service areas.

cleat An assembly of two pieces of insulating material provided with grooves for holding one or more conductors at a definite spacing from a wall or surface and from each other, and having screw holes for fastening the cleats in position.

click filter A filter circuit used to eliminate or reduce key clicks in a radiotelegraph transmitter.

clinometer An instrument for measuring the angle of slope.



Crocodile clip with rubber insulating sleeve, and a small, plain spring clip for temporary connections.

clip A small spring clamp attached to the end of a wire or test probe. Used for making a temporary connection to a terminal.

clipper The television receiver circuit that separates the control impulses from video signals. Also called *amplitude separator* or *synchronizing separator*.

clipping The perceptible mutilation of signals or speech syllables during transmission. It may be in the form of initial and/or final clipping.

clockwise The direction of rotation in which the hands of a clock move.

close coupling The coupling obtained when the primary and secondary windings of a radio-frequency or intermediate-frequency transformer are very close together.

closed circuit A complete electric circuit through which current can flow.

closed-circuit voltage The voltage at the terminals of a battery or other voltage source when a specified current is flowing through the load circuit.

closed magnetic circuit A complete magnetic circuit.

closeup In television, a scene obtained either by moving the camera close to the subject or by using a long-focus lens, so as to secure a larger-than-normal image.

cloud chamber An enclosure containing air supersaturated with water vapor by sudden expansion, in which rapidly moving particles are revealed by streaks of droplets called cloud tracks. Also called *expansion chamber* or *fog chamber*. The Wilson chamber is a special type of cloud chamber.

cloud track A streak of droplets formed in a cloud chamber along the path of an ionizing particle.

cm Abbreviation for centimeter.

cm⁻¹ A unit of frequency employed chiefly in infrared spectroscopy. By definition, 1 cm⁻¹ is equal to 1 divided by the wavelength in centimeters.

cm² Abbreviation for square centimeter.

cm³ Abbreviation for cubic centimeter.

C network A network composed of three impedance branches in series, the free ends of the network being connected to one pair of terminals, and the junction points being connected to another pair of terminals.

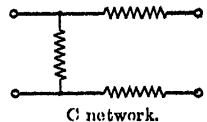

coated filament A vacuum-tube filament that has been coated with metallic oxides to provide increased electron emission.

COATED LENS

coated lens A lens whose surfaces are coated with a transparent film a quarter-wavelength (of light) thick, having an index of refraction that is the geometric mean of the indexes of air and the glass in the lens. This coating minimizes loss of light due to reflection at lens surfaces.

coating The layer of recording lacquer on the surface of a recording disk.

coaxial antenna An antenna that is fed by a coaxial transmission line, with the center conductor projecting vertically upward a quarter-wavelength beyond the end of the line to act as the upper half of a half-wave antenna, and with a quarter-wavelength metal sleeve serving as the lower half. The sleeve surrounds the coaxial line and is connected to the outer conductor of the line at the end of the line.

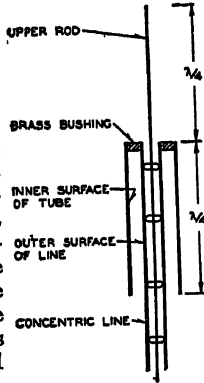

Coaxial antenna.

coaxial cable A metal tube having at its center a wire supported by insulators. It is used as a transmission line for radio or television signals or for transmitting a number of telephone or telegraph messages simultaneously in a carrier system. Also called *coaxial line*, *concentric line*, *pipe line*, etc.



Coaxial cable construction. Insulating disks spaced a few inches apart keep the inner conductor in the exact center of the metal pipe serving as the outer conductor.

coaxial cavity A circular resonating cavity having a central conductor in contact with its pistons or other reflecting devices. The conductor serves to pick up a desired wave. The character of the wave inside a coaxial cavity is that of a wave inside a coaxial cable.

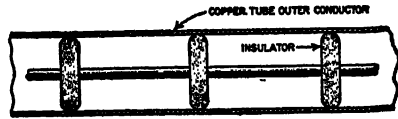

Spaced-insulator type coaxial line.

coaxial line A coaxial cable.

coaxial terminals The concentric output or feedback lines that are coupled to a klystron resonator with wire loops that link the magnetic field in the resonator.

coaxial wavemeter A concentric resonant transmission line used for determining wavelength by measuring recurrent nodes or maxima.

cobalt A metal having slight magnetic characteristics, sometimes combined with iron and steel to make special alloys used in permanent magnets.

codan receiver A carrier-operated anti-noise receiver. Noise is automatically suppressed by reduction of receiver gain during intervals when no carrier is present. Gain is restored to normal by arrival of a carrier.

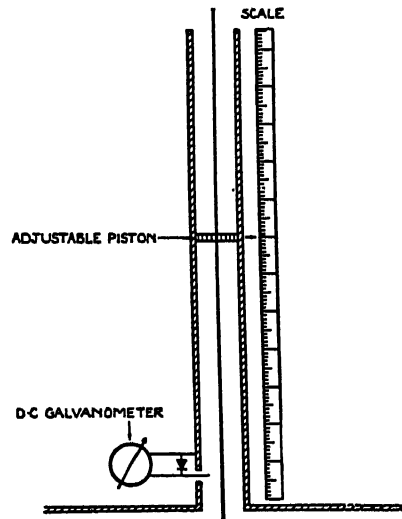

GUIDE

Coaxial resonating cavity used as a wavemeter for determining the frequency of a wave passing through a guide.

code 1. An alphabet consisting of various combinations of long and short signals or intervals, used in the transmission of messages by radio or wire telegraphy. The international Morse code (also called the *continental code*) is universally used in radiotelegraphy. The American Morse Code is used for wire telegraphy in the United States. 2. Any system or set of rules devised to maintain proper technical standards, secure uniformity in production, simplify maintenance, identify terminals, or specify electrical values.

code beacon A flashing beacon light having a recognizable sequence of on and off periods to permit establishment of its identity by aircraft in flight or by ships at sea.

code recorder An instrument that makes a permanent record of code messages received by radio or wire, either by punching holes in a tape or by making dot and dash marks on a tape.

coefficient of coupling A numerical rating between 0 and 1 that specifies the degree of coupling between two circuits. Maximum coupling is 1, and no coupling is 0.

coercive force The magnetizing force at which the magnetic induction is zero for a magnetic material that is being magnetized alternately by magnetizing forces that are equal and of opposite sign. Hence, it is the magnetizing force required in the reverse direction to eliminate the residual magnetism in a previously magnetized iron object.

coercivity The magnetic intensity required to reduce the magnetization to zero in a material that has been previously magnetized to saturation.

coherer A cell containing a granular conductor between two electrodes. The cell becomes highly conducting when subjected to an electric field, and conduction can then be

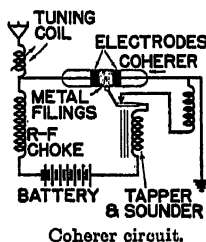

stopped only by jarring the granules. It was formerly used as a detector in wireless telegraphy.

coil A spiral of wire, usually having a relatively large number of turns wound close together on a coil form made from insulating material. It may or may not have an iron core passing through its center but offers little opposition to direct current. The electrical size of a coil is called its inductance, is designated L , and is expressed in henrys. Sometimes called *inductor*.

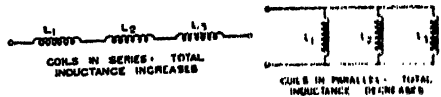

Rules for combining coils in series and in parallel.

coil constant The ratio of the reactance of a coil to the effective resistance at a given frequency.

coil form The tubing or other object on which a coil is wound. It may have any shape, and is generally made from an insulating material such as paper, cardboard, fiber, bakelite, wood, glass, or a plastic or ceramic material.

coil loading Loading in which inductors, commonly called loading coils, are inserted along the line at intervals, either in series or in parallel.

coincidence counter A device for counting pulses that occur in separate circuits at exactly the same time.

cold cathode A cathode that is not heated. Electrons may be pulled out of it by a sufficiently high voltage applied to a pointed anode as in the type BH gaseous rectifier tube. The cathode of a phototube may be considered in this class since it emits electrons when exposed to light rather than heat.

cold-cathode tube A vacuum tube in which the cathode is not heated.

collector 1. An electrode used to collect electrons in certain types of electronic tubes. In a cathode-ray television camera tube, it may be a conductive

COLLECTOR RINGS

coating or ring on the inside of the glass envelope about halfway between the mosaic screen and the electron gun. 2. An exploring electrode or probe built into a vacuum tube to study the distribution of voltage in the space between the electrodes. 3. A metal cylinder, as a Faraday cylinder, used to collect charged particles.

collector rings The slip rings of an alternating-current rotor shaft, serving with the brushes to provide a means of collecting the electrical energy generated.

collinear array An antenna array in which the half-wave elements are arranged end to end on the same straight line. It may be mounted either horizontally or vertically.

collision An encounter between atoms, molecules, ions, electrons, etc., that generally results in an exchange of energy and a change in condition. Thus, the collision between an electron and a molecule can result in ionization of the molecule, giving a positive ion and two or more electrons.

colloidal graphite Extremely fine flakes of graphite suspended in water, petroleum oil, castor oil, glycerine, or other liquids. Used in one form to provide a conductive shield on the inside surface of the glass envelope of a vacuum tube.

colloidal particles Electrically charged particles suspended in a fluid or other medium. They are larger than atomic or molecular dimensions but sufficiently small to exhibit the Brownian movement.

colorama tuning indicator An arrangement of colored lights and a saturable-core transformer used to indicate when a receiver is accurately tuned to a station. Green lights glow when the tuning is correct. Red lights glow between stations or when the tuning is incorrect.

color code A system of colors used to indicate the electrical value of a radio part or to identify terminals and leads.

color response The relative sensitivity to the different colors of light of the human eye, photoelectric cells, and other devices.

color television A television system that reproduces an image in its original colors.

color transmission The transmission of television signals that can be reproduced with different color values.

Colpitts oscillator A vacuum-tube oscillator circuit in which two capacitors are connected in series across the tank coil, with the junction of the capacitors connected to the cathode.

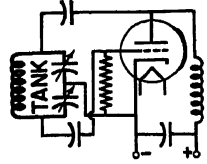

Colpitts oscillator circuit.

commentator One who edits and broadcasts news at a radio station, interspersed with personal opinions.

commercial operator license One of the six classes of licenses issued by the Federal Communications Commission to those authorized to operate a radio station: radiotelephone second-class operator license, radiotelephone first-class operator license, radiotelegraph second-class operator license, radiotelegraph first-class operator license, restricted radiotelephone operator permit, restricted radiotelegraph operator permit.

Commission The Federal Communications Commission.

communication The science of transmitting intelligence between two or more points.

communication band The band of frequencies effectively occupied by the emission of a radio transmitter, for the type of transmission and the speed of signaling used.

Communications Act The Communications Act of 1934, as amended.

communications control radio station The radio station of a group or network of associated radio stations that is responsible for regulating the handling

of radio traffic among the stations in the group.

communications receiver A receiver designed especially for reception of voice or code messages transmitted by radio-communication systems.



Communications receiver.

communications traffic Authorized messages for transmission by the telecommunications services.

communication system Any means of exchanging intelligence (by voice, code, facsimile, etc.) between two or more points.

commutate To convert an alternating current into a direct current by means of a commutator that reverses the direction of current flow during alternate half cycles.

commutating pole An auxiliary pole placed between the main poles of a direct-current generator or motor to produce a flux that assists reversal of current in the short-circuited armature coil at each instant, thereby reducing sparking at the commutator. Also called *interpole*.

commutation 1. Use of a rotating commutator and fixed brushes to change a generated alternating voltage to a pulsating direct voltage in a generator. 2. The process of shifting a low current automatically from one rectifier tube to another in a high-power multitube rectifier system.

commutator 1. A cylindrical arrangement of copper segments mounted radially on the shaft of an armature, separated from each other and the armature by insulation, and connected to individual armature coils. Fixed brushes make contact with the rotating commutator segments at the correct positions to give mechanical rectification of the alternating voltage generated in the armature coils of a direct-current generator, or to apply the external voltage to the correct armature coils at each instant in a direct-current motor. 2. A key, switch, or other device used to reverse the direction of a current.

commutator segment One of the insulated copper bars in a commutator.

compandor A system for improving the signal-to-noise ratio in a radio system by compressing the volume range of the emitted signal energy at the transmitter by means of a compressor, and expanding it again at the receiving apparatus with an expander.

compass A small permanent magnet mounted in such a way that it can rotate freely. It takes a position parallel to the magnetic lines of force of the earth and hence points toward the north and south magnetic poles of the earth.

compensated loop direction finder A direction finder with a loop antenna and with a second antenna system provided to compensate polarization error.

compensator That portion of a radio direction finder which applies part or all of the necessary correction to the directional indication.

complementary wave A wave brought into existence at the ends of a coaxial cable or two-conductor transmission line or at any discontinuity along the line. It resembles in character the waves propagated in wave guides. Normally these complementary waves are highly attenuated and can be neglected.

complex impedance Impedance consisting of both resistance and re-

COMPLEX ION

actance, and hence expressible by a complex quantity of the form $R \pm jX$.

complex ion A positive ion combined with an uncharged molecule.

complex operator The letter j , used to designate the reactive component of a complex impedance.

compliance In a mechanical element, the displacement per unit of force, expressed in centimeters per dyne. It is the reciprocal of the stiffness. Negative compliance occurs when a small displacement results in a force tending to give a further displacement in the same direction. Compliance in a mechanical system is equivalent to capacitance in an electrical system.

component 1. One of the parts in a complete circuit. 2. One of the separable parts that make up a voltage, current, radio wave, force, etc., and that may be considered by itself. As an example, a pulsating current has an alternating-current component.

composite Made up of several distinct parts or elements.

composed circuit A circuit that can be used simultaneously for telephony and direct-current telegraphy or signaling, separation between the two being accomplished by frequency discrimination.

composite filter A low-pass filter consisting of a constant-K filter in series with an m-derived filter. It gives sharp cutoff with good attenuation above the cutoff frequency.

composite intermediate-frequency coil A combination intermediate-frequency coil and oscillator coil mounted on a single dowel and usually contained in a single shield.

compound A chemical combination of two or more elements.

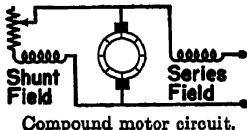

compound winding A motor or generator field arrangement in which one part of each field coil winding is connected in series with the armature and the other part is connected in parallel with the armature.

compression 1. Narrowing the volume range of an audio-frequency signal, so that weak passages in a musical number will not be lost in background noise and loud passages will not overload any part of the radio system. 2. The dense region, in air or some other medium, that forms alternate half-cycles of a sound wave produced by a vibrating body. 3. In facsimile, a reduction in white-to-black amplitude range or frequency swing, occurring between two points in the system.

concave-convex lens A lens that is curved inward on one side and is curved outward on the other side.

concave lens A lens that is curved inward on one side and is flat on the other side.

concave mirror A polished reflecting surface that is curved inward like the inside surface of a ball.

concentration cell An electrolytic cell whose voltage is due to a difference in concentration between different parts of the electrolyte.

concentric Pertaining to two or more objects having a common center.

concentric line A metal tube having at its center a wire supported by insulators. It is used as a transmission line for radio or television signals or for transmitting a number of telephone or telegraph signals simultaneously in a carrier system. Also called *coaxial cable*, *coaxial line*, *pipe line*, etc.

concentric-line oscillator A vacuum-tube oscillator in which a concentric line is used as a tank circuit.

condensance A little-used term for capacitive reactance.

condenser 1. Deprecated term for capacitor. 2. A system of lenses designed to intercept a large cone of rays

CONFORMAL WIRE GRATING

from a lamp or carbon arc and concentrate these rays within a limited area.

3. An apparatus in which steam is condensed to water, or other gases or vapors are condensed to a liquid or solid state.

condenser loudspeaker. A capacitor loudspeaker.

condenser microphone A capacitor microphone.

condenser pickup A capacitor pickup.

conductance That property of a circuit or body which determines how much current will flow for a given applied electromotive force or a given potential difference. Conductance is measured in mhos and designated by *G*. Conductance is the reciprocal of resistance, and hence is a measure of the ability to conduct electricity.

conducting guide A class of wave guides consisting of a metal tube either filled with gas or air or evacuated, and capable of propagating electromagnetic waves through its interior much as sound waves travel through a speaking tube. Guides with circular or rectangular cross-sections are most commonly used. The frequencies involved in wave-guide phenomena are of the order of 1,000 megacycles or higher.

conduction current 1. A current comprising the movement of negative electricity (electrons) through a body. The current due to moving masses heavier than electrons, such as charged particles moving through a gas or vacuum, is called convection current. 2. That component of dielectric current which flows through a surface in an imperfect dielectric and is proportional to the potential gradient. It is measured after the electric field has remained unchanged for so long a time that the current has become constant.

conductivity The ability of a material to conduct electricity, as measured by the current intensity per unit of applied voltage. It is the reciprocal of resistivity.

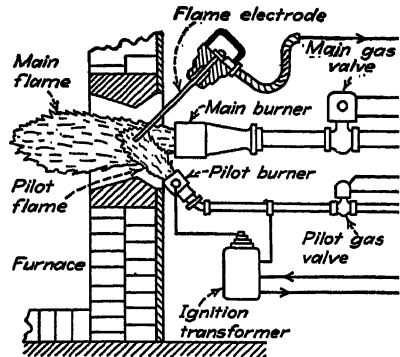

Flame-failure detector utilizing the conductivity of a flame.

conductor Any wire, cable, or other object suitable for carrying electric current. A good conductor offers little opposition to current flow.

conduit Solid or flexible metal or other tubing through which insulated electric wires are run.



Cone and voice coil assembly of a dynamic loudspeaker.

cone The conical-shaped paper or fiber diaphragm of a loudspeaker.

cone loudspeaker A loudspeaker employing a magnetic driving unit that is mechanically coupled to a paper or fiber cone.

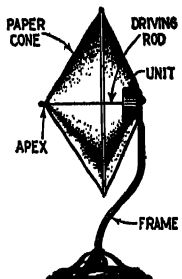

Early cone loudspeaker.

cone of silence The area directly over the antenna of a radio-beacon transmitter in which no signal is heard by the pilot of an aircraft.

configuration The relative distribution or arrangement of parts in a structure, as in an antenna array.

conformal wire grating A wire grating in which the wires are bent to conform to the lines of electric force that are characteristic of the wave that is to be reflected by the grating. These gratings can be made to pass or

CONICAL HORN



Typical conformal wire gratings for circular wave guides. The grating of radial wires blocks $E_{0,n}$ waves (all types of E_0 waves) and passes $H_{0,n}$ waves; the circular grating blocks $H_{0,n}$ waves and passes $E_{0,n}$ waves; and that at the right blocks the $H_{1,1}$ wave.

obstruct one or more types of waves while obstructing or passing all other types, and hence act much like filters in radio circuits. Examples are radial gratings and circular gratings.

conical horn A cone-shaped horn whose radius increases uniformly along the axis.

conjugate impedances Impedances that have equal resistance components, with reactance components that are equal in magnitude but opposite in sign.

connection A joint that provides a path for current between two points in a circuit.



Connector for antenna lead of auto-radio set.

connector Any device that joins or couples two or more parts, such as two cables.

conoscope An instrument used for determining the position of the optical axis of a quartz crystal. Monochromatic polarized green light, obtained from a mercury lamp having suitable light filters and a polarizing slide, is passed through the crystal. A pattern of concentric circles is seen in the viewing system. The crystal is rotated until these circles are centered on the crosshairs, and the angle of the optical axis is then read on the instrument.

consequent poles Magnetic poles occurring at some place other than at the ends of a magnet.

console A large cabinet for a radio or television receiver, standing on the floor rather than on a table.

console receiver A radio receiver in a console cabinet.

constant-amplitude recording A sound-recording method in which all frequencies are inscribed at the same amplitude when they have the same intensity. The method gives desirable reduction of surface noise at higher audio frequencies, but involves certain mechanical difficulties that limit its use.

constantan An alloy containing 60 per cent copper and 40 per cent nickel, used in making precision wire-wound resistors because of its low temperature coefficient of resistance. Another alloy similarly used is manganin.

constant-current generator A vacuum-tube circuit, generally containing a pentode, in which the alternating-current plate resistance is so high in comparison to the plate load resistance that plate current remains essentially constant despite variations in load resistance.

constant-current modulation A method of modulating a carrier wave in which the plates of both the radio-frequency oscillator and modulator tubes are fed through a common inductor having high impedance. The inductor prevents any change in total plate current drawn by the two tubes together; hence audio-frequency plate-current variations in the modulator tube produce similar but opposite audio-frequency variations in the plate current of the radio-frequency oscillator tube. Also called *Heising modulation*.

constant-current transformer A transformer that automatically maintains a constant current in its secondary circuit under varying loads, when supplied from a constant-voltage source.

constant groove speed A phonograph turntable so designed that the linear speed of the groove with respect to the stylus is independent of the diameter of the groove. Used in embossing forms of recording.

CONTRAST CONTROL

constant-speed motor An electric motor that operates at essentially the same speed when carrying a full load as when handling a light load.

constant-voltage transformer A transformer designed to deliver an essentially constant output voltage despite severe fluctuations in power-line voltage.

contact To join two conductors or conducting objects in order to provide a complete path for current flow.

contact microphone A microphone designed to pick up mechanical vibrations directly and convert them into corresponding electrical currents or voltages. When used with wind, string, and percussion musical instruments, it is strapped or clamped to the housing of the instrument. When used in vibration analysis of machinery, it is held against various parts of the machinery. When used as a throat microphone, it is strapped against the throat of the speaker. When used as a lip microphone, it is held against the lips of the speaker.

contactor A device, operated other than by hand, for repeatedly establishing and interrupting an electric circuit.

contact potential The difference of potential that exists when dissimilar metals are placed in contact. Also called *Volta effect*.

contact resistance The resistance in ohms between the contacts of a relay, switch, or other device when the contacts are touching each other. The value is generally a fraction of an ohm, but is highly important in that it determines the current-carrying capacity of the contacts. Excessive contact resistance causes heating which rapidly deteriorates the contacts.

contacts Conducting parts that coact to complete or interrupt a circuit.

continental code The International Morse Code, universally used for radiotelegraphy.

continuity 1. The presence of a complete path through which current can flow. 2. Commercial announcements,

introductions for musical numbers or speakers, and other material ordinarily read by an announcer at a radio station.

continuity writer A writer who prepares the continuity used by announcers between musical numbers and speeches on a radio program.

continuous current A unidirectional current (flowing in one direction at all times) in which the value is essentially constant. Also called *direct current*.

continuous duty Operation of a machine or apparatus at a substantially constant load for an indefinitely long time.

continuous loading Loading in which added inductance is distributed continuously along the conductors of the line.

continuous rating The rating applying to operation for an indefinitely long time, or defining the load that may be carried for an indefinitely long time.

continuous spectrum A spectrum that appears to represent a continuous variation of wavelength from one end to the other. An example is the spectrum of an incandescent lamp.

continuous wave A radio wave in which successive cycles have constant amplitude and are otherwise identical under steady-state conditions.

contour 1. The geometrical form of a surface. 2. An imaginary line used chiefly on maps to connect those points on a land surface at which a radio station provides the same signal intensity, or to connect points having the same elevation.

contrast The degree of difference in tone between the lightest and darkest areas in a photograph, facsimile reproduction, or received television picture. Contrast is measured in terms of gamma, a numerical indication of the degree of contrast. Contrast is the opposite of detail; low or poor contrast means good reproduction of details.

contrast control The manual control provided in a television receiver to

CONTROL

change the amplification or gain. In effect, it varies the contrast between bright and dark portions of the reproduced image by increasing or decreasing the range between black and the brightest possible area.

control Adjusting conditions in a system through some influence not connected with that system. With automatic control there is no feedback, whereas with regulation there is feedback of the condition being regulated. Regulation keeps constant some condition such as speed, temperature, voltage, or position by means of electronic or other systems that automatically measure the output of the machine or process and correct errors.

control area radio station The aeronautical ground radio station through which the air traffic control officer in charge of an aircraft communicates.

control characteristic In a gas tube, the relation between critical grid voltage and anode voltage. Usually shown by a graph.

control electrode Any electrode to which varying voltage is applied with respect to the cathode for the purpose of varying the current flowing between two or more electrodes.

control grid A grid, ordinarily placed between the cathode and an anode, for use as a control electrode.

control grid-plate transconductance See *transconductance*.

controlled mercury-arc rectifier A mercury-arc rectifier in which one or more electrodes are employed to control the starting of the discharge.

controlled rectifier A rectifier provided with means for controlling its output current, usually by means of grid-controlled thyatrons or ignitrons.

controller Any device that controls the operation of electric machinery to which it is connected. In addition to providing for starting and stopping, it may control the speed and sometimes also the direction of motion, and can be used for sustained periods of time on intermediate speed steps.

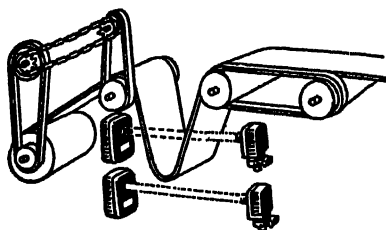

Photoelectric slack control.

control room That room in a broadcast station from which engineers and production men control a radio program. It is adjacent to the main studios and separated from them by large double glass windows.

control wheel A wheel attached to the shaft of a large adjustable unit of a transmitter or other heavy-duty electronic equipment. It generally has a pointer moving over a calibrated dial.

convection current A current in which electricity is carried by moving masses heavier than electrons. That due to electrons alone is called conduction current.

convective discharge A discharge of electricity through air between the terminals of a high-voltage source, consisting of visible or invisible streams of charged particles.

convenience receptacle A spring-contact device installed at an outlet and connected permanently to the power-line wiring of a building. It permits connection of a portable lamp or appliance to the power line by means of a plug and flexible cord. Also called *receptacle* or *wall outlet*.

convergent beam A beam consisting of light rays that meet (converge) at a point.

converse magnetostrictive effect The change in the magnetization of a ferromagnetic material during deformation due to pressure or twisting. It is the reverse of the magnetostrictive effect.

converse piezoelectric effect The deformation of a piezoelectric crystal when a voltage is applied between

COPPER-CLAD STEEL WIRE

opposite faces. It is the reverse of the piezoelectric effect.

conversion transformer A coupling device used to join a balanced two-wire transmission line to a coaxial line.

conversion transconductance 1. The magnitude of a single beat-frequency component of the output-electrode current of a vacuum tube divided by the magnitude of the control-electrode voltage of frequency f_1 , under the conditions that all direct electrode voltages and the magnitude of the electrode alternating voltage f_2 remain constant. Furthermore, there must be no impedances in the output circuit at the frequencies f_1 or f_2 . 2. A characteristic of a vacuum tube when used as a mixer, having the same meaning then as transconductance.

converter 1. That section of a superheterodyne radio receiver which converts the desired incoming radio-frequency signal to a lower carrier frequency known as the intermediate-frequency value. The converter section includes the oscillator stage and the mixer-first detector stage, these sometimes being combined in a single stage called the converter. 2. A rotating machine consisting of an electric motor driving an electric generator for the purpose of changing alternating current to direct current as in a motor-generator or rotary converter, changing to a different frequency as in a frequency converter, or changing to a different number of phases as in a phase converter. 3. In facsimile, a device that changes the type of modulation delivered by the scanner.

converter noise Noise originating in the converter section of a superheterodyne receiver.

converter tube A multi-element vacuum tube utilized both as a mixer and as an oscillator in a superheterodyne receiver.

convex lens A lens that is curved outward on one side and is flat on the other side.

convex mirror A polished reflecting surface that curves outward.

Coolidge tube A type of X-ray tube using a heater-type cathode to furnish cathode-ray electrons by thermionic emission. It contains an incandescent tungsten cathode and a water-cooled or air-cooled anode in a vacuum at least as low as 0.00000003 atmosphere, and has a self-rectifying effect that permits operation from high-voltage alternating current without a rectifier.

Cooper-Hewitt lamp A mercury-vapor lamp that was once widely used in photography, photostat work, and certain medical applications. It produces a bluish-green light having a high ultraviolet content. The process is entirely electronic, involving ionization of mercury vapor in a glass tube when a sufficiently high voltage is applied between two electrodes. It usually has the form of a long glass tube that is tilted either by hand or automatically for starting the arc.

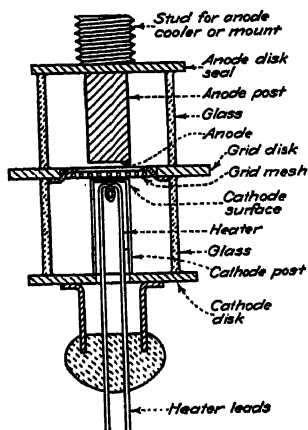

Coplanar electrodes in a disk-seal tube.

coplanar electrodes Electrodes arranged in parallel planes or layers in a vacuum tube, as in a megatron.

copper An element having good conductivity, widely used in electronics for conductors.

copper-clad steel wire Steel wire to which has been welded a coating of copper, as distinguished from copper-plated or copper-sheathed material.

COPPER LOSS

copper loss Power loss in transformers, generators, connecting wires, or other parts of a circuit due to current flow through the resistance of the copper conductors. Also called I^2R loss.

copper-oxide meter An instrument that measures alternating currents or voltages by passing the alternating current through a full-wave copper-oxide rectifier, then measuring the resulting direct current with a conventional direct-current milliammeter having a scale calibrated in alternating-current values.

copper-oxide modulator A modulator employing a copper-oxide rectifier as the modulating element.

copper-oxide photovoltaic cell A type of photovoltaic cell in which light acting on the surface of contact between layers of copper and cuprous oxide causes an electromotive force to be produced. Usually called a *barrier-layer cell* or *blocking-layer cell*.

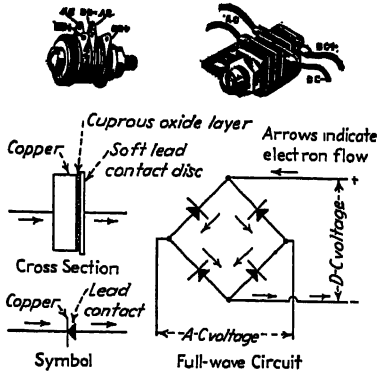

Copper-oxide rectifiers, with construction, symbol, and typical circuit.

copper-oxide rectifier A rectifier consisting of a disk of copper coated with cuprous oxide on one side, with a soft lead washer providing electrical contact with the oxide surface. The resistance is considerably lower for electron flow from the copper to the oxide than for electron flow in the reverse direction; hence rectification is obtained in alternating-current circuits. A number of these rectifiers are generally combined, since the break-

down voltage per junction is about 11 volts peak and because the current per junction must be sufficiently low to keep the operating temperature below about 140° Fahrenheit.

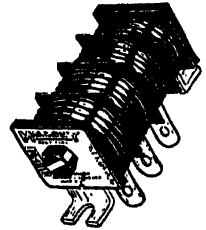

Copper sulphide rectifier used in battery chargers.

copper sulphide rectifier A dry-disk rectifier consisting of magnesium in contact with copper sulphide.

Corbino effect The production of a current along the circumference of a metal disk located in a magnetic field perpendicular to the disk, when a current is sent from the center of the disk to the circumference.

cord A small, highly flexible insulated cable. There is no clear-cut distinction with respect to size between a cord and a cable.

cord circuit A connecting circuit terminating in a plug at one or both ends. Used at switchboard positions for establishing telephone connections.

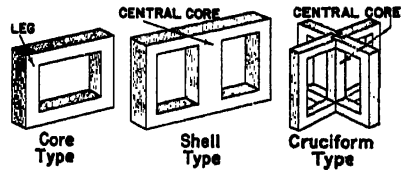

Core constructions for transformers.

core 1. The material that serves as a path for the magnetic flux of a coil. When it is iron or some other magnetic material, the flux is greatly increased. 2. The inner metal base or heating element of a thermionic filament. Here the core is usually covered with a coating of barium and strontium oxide or some other good thermionically active material. 3. The highly stable electron group that remains when a chemically active atom is ionized by the removal of its incomplete outer shell of electrons. Also called *Rumpff* or *kernel*.

COUNTER ELECTROMOTIVE FORCE

coreless-type induction furnace An induction furnace in which the heat is generated within the charge, within the walls of the containing crucible, or in both, by currents induced by a high-frequency magnetic flux produced by a surrounding coil. Also called *high-frequency furnace*.

core losses Losses occurring in an iron-core transformer or inductor due to eddy currents and hysteresis effects in the iron core.

core-type induction furnace An induction furnace that includes a primary winding, a core of magnetic material, and a secondary winding comprising one short-circuited turn of the material to be heated. Also called *low-frequency furnace*.

corona A discharge of electricity appearing as a glow of colored light on the surface of a conductor when the potential gradient exceeds a certain critical value. It is due to ionization of the surrounding air by the high voltage.

corona voltmeter A meter in which voltage is determined by the beginning of a corona discharge.

corpuscular theory The theory that the sensation of light was due to bombardment of the retina of the eye by tiny particles given off by a luminous body. It was proposed by Sir Isaac Newton, and is now known to be incorrect.

corrected radio bearing An observed radio bearing to which all known corrections have been applied.

correction factor A coefficient by which a meter reading or other result must be multiplied in order to make it correct.

corrective network An electric network designed to be inserted in a circuit to improve its transmission properties, impedance properties, or both. Also called *shaping network*.

corrosion A gradual wearing away or disintegration by a chemical process, as the rusting of iron.

cortical stimulator An electronic instrument used in nerve and mental therapy to deliver an electric shock of prescribed strength by means of a pulsating current. A low-frequency relaxation oscillator is sometimes used to produce the pulses.

cosinoidal Varying in proportion to the cosine of an angle or time function. A variation with the sine is sinusoidal.

cosmic rays Highly penetrating radiation of unknown origin, apparently traversing interplanetary space in all directions, and detected by the ionization that it produces in electrosopes, ion counters, etc. Cosmic rays can penetrate 18 inches of solid lead or 200 feet of water.

coulomb A measure of the quantity of electricity that passes a given point in a circuit in a given time. One coulomb is equal to a current of one ampere flowing for one second, or to a movement of 6.3×10^{18} electrons past a point in one second.

Coulomb's law The attraction or repulsion between two electric charges is proportional to the product of their magnitudes and is inversely proportional to the square of the distance between them. The force between unlike charges is an attraction; the force between like charges is a repulsion. Also called the *law of electrostatic attraction*.

coulometer An electricity meter having the form of an electrolytic cell, arranged to measure the quantity of electricity in coulombs passing through a conductor. Actually, it measures the amount of electrolysis produced by the current in the electrolytic cell. Also called *voltameter*.

counterclockwise Rotation in a direction opposite to that of the hands of a clock.

counter electromotive force The voltage developed in an inductive circuit by a changing or alternating current flowing through the circuit. The polarity of the voltage is at each instant opposite that of the applied voltage, and the amplitude or strength is never greater

COUNTER EMF

than that of the applied voltage. Also called *back electromotive force*.

counter emf One of the abbreviations for counter electromotive force.

counterpoise A system of wires supported a few feet above ground and connected to a radio transmitter in place of the usual ground.

countersink To ream, drill, or cut a conical depression around a hole, so that a flathead wood or machine screw will be flush with the surface when inserted in the hole.

counterweight A weight employed in the arms of some pickups and cutters to reduce needle pressure.

counting circuit A circuit that, when receiving uniform pulses representing units to be counted, produces a voltage in proportion to the pulse frequency.

counting tube An ionization chamber used for counting electrons or other ionizing particles. Examples are Geiger counter, Geiger-Muller counter, and ion counter.

couple 1. A pair of metals placed in contact, as in a thermocouple or a voltaic couple. Also, the act of connecting two circuits so that current variations in one will affect the voltage in the other. 2. Two equal and oppositely directed parallel forces acting on a body form a couple.

coupled impedance The effect produced in a circuit by a current flowing in another circuit, such as the effect in a transformer primary winding produced by a current flowing in the secondary winding.

coupler Any device used to transfer electrical energy from one circuit to another by means of inductive, capacitive, or resistive coupling.

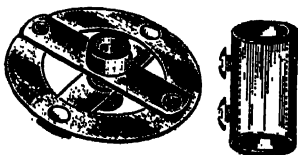

Flexible and rigid couplings.

coupling 1. A mutual relation between two circuits such that it permits transfer of energy between them. 2. A flexible or rigid device used to fasten together two shafts.

coupling capacitor A capacitor used to couple two circuits together.

coupling coefficient A numerical rating between 0 and 1 that specifies the degree of coupling between two circuits. Maximum coupling is 1, and no coupling is 0.

coupling element The common impedance necessary for coupling between two circuits.

coupling transformer A transformer used to couple two circuits together by mutual induction.

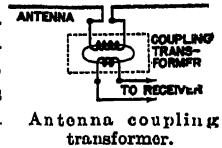

Antenna coupling transformer.

coverage The area effectively served by a broadcast station.

cp Abbreviation for candlepower.

C power supply The grid voltage source for a vacuum tube. It may be a C battery, a power pack, or a grid bias cell.

cps Abbreviation for cycles per second. Preferably written as cycles.

crater 1. The cavity formed in the positive carbon electrode of an electric arc. 2. The depression at the termination of an arc weld.

crater lamp A gaseous lamp, usually containing neon, which provides a point source of light that can be modulated with a signal. Used in sound-on-film recording and in mechanical television systems.

crest factor The ratio of the peak value to the effective value of any periodic quantity such as a sinusoidal alternating current.

crest forward anode voltage The maximum instantaneous anode voltage in the direction in which the tube is designed to pass current.

CROOKES RADIOMETER

crest inverse anode voltage The maximum instantaneous anode voltage in the direction opposite to that in which the tube is designed to pass current.

crest value The maximum value that a quantity attains during the time interval under consideration.

crest voltage Peak or maximum voltage.

crest voltmeter A meter that responds to the crest or maximum value of the voltage applied to its terminals.

critical angle That angle at which a ray of light striking the surface of a transparent medium such as glass will be completely reflected, without passing into the medium.

critical area An area of the subject copy in facsimile whose dimensions are equal to the definition along and across the direction of scanning.

critical coupling

The degree of coupling that provides maximum transfer of signal energy from one radio-frequency circuit to another. Also called *optimum coupling*.

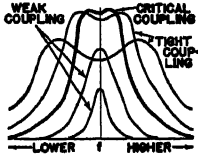

Response curves. Critical coupling gives maximum response.

critical damping That amount of damping which causes a body that is displaced against a potential or an elastic force to come to rest in the shortest possible time without overshooting the rest position. Thus, in a critically damped meter, the pointer rises to its final position without overshooting and oscillating above and below this position.

critical frequency 1. The cutoff frequency of a filter at which the attenuation constant changes from zero to a positive value, or vice versa. 2. The frequency at which the quantum energy is just sufficient to release photoelectrons from a given surface. Sometimes called *threshold frequency*. 3. The frequency of intermittent illumination that is just sufficient to prevent a sensation of flicker. 4.

The frequency, for an ionized layer of the ionosphere, at which the virtual height for a wave component at vertical incidence has a maximum value corresponding to penetration of the wave through the layer. It is the highest frequency that will be reflected from the layer except for sporadic and scattered reflections. Also called *penetration frequency*.

critical grid current In a gas tube, the instantaneous value of grid current at the time when anode current starts to flow.

critical grid voltage In a gas tube, the instantaneous value of grid voltage at the time when anode current starts to flow.

critical wavelength The wavelength corresponding to the critical or threshold frequency in a quantum process brought about by radiation.

cro Abbreviation for cathode-ray oscilloscope.

Crookes dark space The portion of the glow discharge in a Crookes tube, length of neon tubing, or other discharge tube which is between the cathode glow and the negative glow. It is nonluminous. Also known as *cathode dark space*.

Crookes radiometer An apparatus resembling a miniature four-vane windmill mounted in a glass vacuum tube, used to demonstrate the intensity of radiant energy. The vanes are polished on one side and blackened on the other. Absorption of radiant energy and the resulting rise in temperature at the blackened faces produce forces that cause the vane to spin in sunlight.

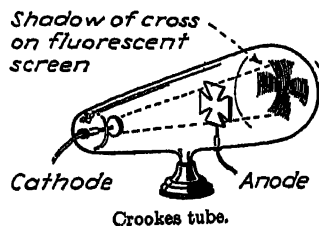

Crookes tube.

CROOKES TUBE

Crookes tube An early form of vacuum tube, used by Sir William Crookes in his studies of cathode rays and electrical discharges at low pressures.

Crosby exciter A highly stabilized exciter unit developed by M. G. Crosby for frequency-modulated transmitters. This exciter generates the resting frequency or assigned carrier frequency of the transmitter.

cross modulation A type of station interference in which the carrier of a desired signal becomes modulated with an undesired signal. The program of the undesired station is then heard in the background of the desired program. It occurs because the first tube in the receiver acts as a detector for the strong undesired signal.

crossover frequency 1. That frequency, in a woofer-tweeter loudspeaker combination, at which equal power is delivered to both loudspeakers. Below this frequency, the output of the low-frequency loudspeaker predominates, while above this frequency, the output of the high-frequency loudspeaker predominates. 2. Sometimes erroneously applied to the frequency at which changeover from constant-amplitude recording to constant-velocity recording occurs in a record.

crossover point The point at which converging light rays or electron beams cross and begin to diverge.

crosstalk Interfering conversation heard in a telephone system or in a radio system containing telephone lines.

cruciform core A transformer core design in which all windings are placed on the central leg and in which there are four separate outer legs serving as return paths for magnetic flux.

crystal 1. A piece of natural quartz or other material possessing piezoelectric properties. A quartz crystal can be ground to dimensions such that it will vibrate naturally at a desired radio frequency and generate that frequency when kept vibrating. Crystals are used in transmitters to generate the assigned carrier fre-

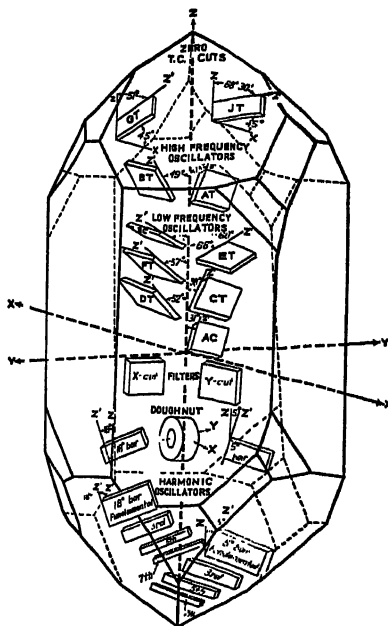

Standard types of cuts made in quartz crystals. The angle of the cut with respect to the natural faces of the crystal determines the electrical characteristics of the finished crystal plate.

quency with a high degree of accuracy. In receivers and radio-frequency amplifiers, they are used in filter circuits to improve selectivity and provide a desired frequency response. Crystals of Rochelle salt are used in crystal microphones and crystal pickups. 2. A mineral crystal, such as carborundum, used for rectifying purposes in a crystal detector.

crystal analysis The study of the arrangement of molecules, ions, or atoms in crystals, chiefly by X-ray methods.

crystal control Use of a quartz crystal to maintain the carrier frequency of a radio station within the legal limits of its assigned frequency.

crystal detector An early form of detector that used a silicon, galena, carborundum, or other crystal in contact with a pointed

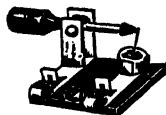

Crystal detector.

CRYSTAL OVEN

wire to rectify an incoming radio signal.

crystal filter A highly selective circuit employing one or more quartz crystals. It is sometimes used in the intermediate-frequency amplifier of a communications receiver to give improved selectivity when a large number of stations are operating in the desired band.

crystal holder A housing designed to provide proper electrical contacts for a quartz crystal. It may have terminal prongs to permit plugging into a socket. It may have a variable air gap to permit varying the frequency of oscillation over a limited range.

crystalline finish A lacquer finish that may be applied to wood, metal, and many other materials. It dries as a surface having an irregular fine-line crystalline pattern.

crystallography That branch of physical science which deals with the geometrical forms of crystals.

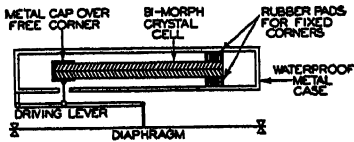

Constructional features of a crystal loudspeaker.

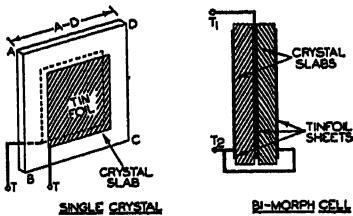

Bimorph cell and single crystal as used in crystal microphones, phonograph pickups, and loudspeakers.

crystal loudspeaker A loudspeaker in which diaphragm movements are produced by a piezoelectric crystal element that is twisting or bending under the influence of the applied signal voltage.

crystal microphone A microphone in which deformation of a piezoelectric

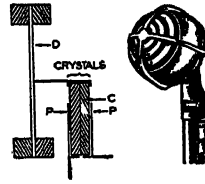

Crystal microphone and diagram illustrating operating principle. Sound waves move diaphragm *D*, applying bending force to crystals *C* and making them generate a voltage picked up by electrode plates *P*.

crystal (usually Rochelle salt) by sound waves or mechanical vibrations generates the output voltage between the faces of the crystal.

crystal mixer A device employing the nonlinear characteristic of a crystal to mix two frequencies. Crystals used for this purpose do not possess piezoelectric qualities.

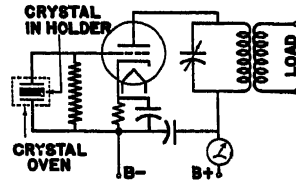

Crystal oscillator circuit.

crystal oscillator A vacuum-tube oscillator in which the frequency is determined by a piezoelectric crystal, usually quartz.

crystal oven A small electrically heated compartment in which the crystal holder and crystal are mounted. The oven is kept at essentially constant temperature by an automatic-temperature-control system to prevent the crystal from drifting in frequency with changes in temperature.

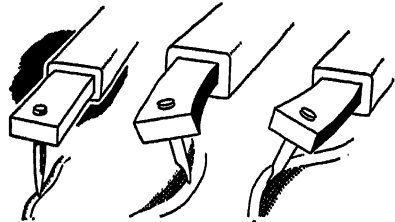

Twisting Action

Twisting action utilized in a crystal pickup.

CRYSTAL PICKUP

crystal pickup A phonograph pickup in which deformation of a piezoelectric crystal (usually Rochelle salt) is caused by movements of the phonograph needle in the record groove. This generates the output voltage across the faces of the crystal.

crystal plate A precisely cut slab of quartz crystal that has been lapped to final dimensions by using increasingly finer abrasive materials. The plate is then thoroughly cleaned and etched to remove loose particles and improve stability and efficiency. Metallic coatings, generally aluminum, silver, or gold, are sometimes deposited directly on the major surfaces of the crystal plate to serve as electrodes.

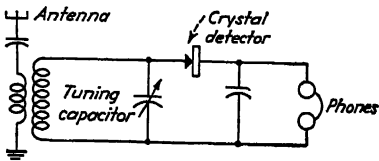

Circuit of typical crystal set.

crystal set A radio receiver having no vacuum tubes, using a crystal detector to demodulate the received signals.

crystal unit The complete assembly of a crystal plate in its mounting and case, involving the use of electrodes on or near the crystal surfaces for impressing voltage across the crystal plate, supports for holding the crystal plate in its mount, and a sealed outer case having the necessary terminals.



Crystal unit.

Cs Chemical symbol for caesium, an element used on the cathodes of some phototubes.

CST Abbreviation for Central Standard Time.

C supply C power supply for tubes.

CT Abbreviation for the center tap of a winding.

Cu Chemical symbol for copper.

cu Abbreviation for cubic.

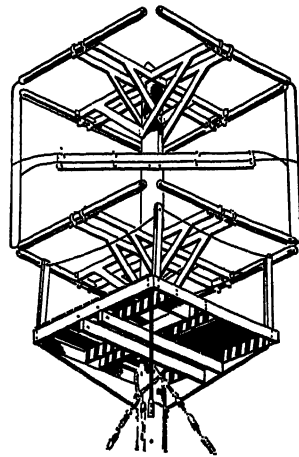

Cubical antenna used by television station W2XKB.

cubical antenna An antenna array whose elements are positioned to form a cube.

cubicle A metal cabinet or other enclosure in which the equipment for a stage or section of a transmitter or other electronic device is mounted.

cu cm Abbreviation for cubic centimeter.

cue A signal given during a radio or television broadcast, calling for a predetermined action on the part of performers, announcers, or technical personnel. Thus, on network programs the network identification at the end of a program period could be the cue for telephone and radio operators to switch channels and lines in preparation for the next network program.

cue sheet An orderly tabulation of scheduled programs, indicating all cues.

cu ft Abbreviation for cubic foot.

cu in Abbreviation for cubic inch.

cuprous oxide A powdery reddish material (Cu_2O) formed on copper that has been only partially burned or oxidized. Electrons flow readily only in the direction from the metallic copper toward the oxide layer on the surface, and this effect is utilized for rectification in copper-oxide rectifiers.

CURRENT-WAVELENGTH CHARACTERISTIC

curie A unit quantity of radium emanation or radon, defined as that quantity which is in equilibrium with one gram of radium.

Curie point The temperature of a ferromagnetic material at which, with increasing temperature, the transition from ferromagnetic to paramagnetic properties appears to be complete. Also called *magnetic transition temperature*.

current The rate of transfer of electricity. The practical unit of current is the ampere, which is a transfer of one coulomb per second.

current amplification The ratio of the current produced in the output circuit of an amplifier to the signal current supplied to the input circuit.

current antinode A point at which current is a maximum along a transmission line, antenna, or other circuit element having standing waves. Also called *current loop*.

current density 1. The current flowing per unit cross-sectional area of a conductor. 2. The current density at a point is a vector having the same direction as the current and having a magnitude equal to the quotient of the current flowing through an infinitesimal area surrounding the point and perpendicular to the direction of the current, divided by the area.

current feed Feeding current to a transmitting antenna at a point of maximum current flow, as at the center of a half-wave antenna.

current-limiting resistor A resistor inserted in an electric circuit to limit the flow of current to some predetermined value.

current loop A current antinode.

current node A point at which current is zero along a transmission line, antenna, or other circuit element having standing waves.

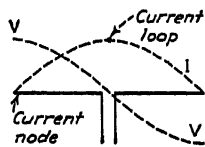

Current loop and current nodes on a half-wave doublet in free space.

current regulator A device that functions to maintain the output current of a generator or other voltage source at a predetermined value, or varies the voltage according to a predetermined plan.

current relay A relay that functions at a predetermined value of current.

current saturation The condition in which the plate current of a thermionic vacuum tube cannot be further increased by increasing the plate voltage. The electrons are then being drawn to the plate at the same rate as they are emitted from the cathode. Also called *plate saturation* or *voltage saturation*.

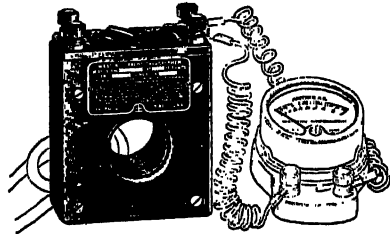

Current transformer, showing meter connections and how line is looped through the transformer.

current transformer An instrument transformer intended for measurement or control purposes, and designed to have its primary winding connected in series with the circuit carrying the current to be measured or controlled. An alternating-current ammeter with its scale calibrated to read primary current is connected across the secondary. It avoids having heavy-current or high-voltage leads connected to the instrument directly. Sometimes the primary consists simply of one or more turns of the current-carrying conductor looped through the center of the transformer core.

current-type telemeter A telemeter that employs current as the translating means.

current-wavelength characteristic The phototube characteristic that reveals, usually by means of a graph, the relation between the wavelength of incident radiant flux and the direct

CURVATURE OF FIELD

anode current per unit energy of the incident radiant flux.

curvature of field A type of spherical aberration in which the image is sharply focused on a curved surface instead of a plane. When this image is produced on a flat surface, either the edges or the central portion of the image will be blurred.

curvilinear cone A loudspeaker diaphragm having a parabolic shape, used to secure pure piston action whereby the entire cone moves as a unit. Sometimes called *para-curve*.

cushioned socket A vacuum-tube socket having a spring or soft rubber mounting in order that chassis vibrations will not affect operation or injure the tube.

cut 1. A plane section of a crystal, with two parallel major surfaces cut in any orientation. Cuts are either specified by a direction normal to the major surfaces of the crystal or by special distinguishing symbols. Thus, an *X* cut has major surfaces perpendicular to the *X* axis of the natural crystal. 2. To remove spoken or musical material from the script for a radio program to make it fit the available time. 3. A command to stop an action, as to disconnect all microphones so nothing more can go on the air, or to turn off a television camera.

cutoff 1. The minimum value of negative grid bias that will prevent the flow of plate current in a vacuum tube. 2. In a selective circuit, the frequency above or below which the circuit fails to respond.

cutoff frequency In a filter, the frequency at which the attenuation constant changes from zero to a positive value, or vice versa. Also called the critical frequency of a filter, because it represents a frequency limit beyond which the filter begins to suppress or cut off signals.

cutoff limiting Limiting the maximum output voltage of a vacuum-tube circuit by driving the control grid beyond the cutoff value.

cutoff wavelength The critical wavelength above which the attenuation of a wave guide increases rapidly.

cutout Any device, usually electromagnetic, that opens a circuit automatically when the current exceeds or drops below a predetermined value.

cutter An electromagnetic or piezoelectric device having a diamond or hard alloy steel stylus, used to cut a wavy line on the moving highly polished wax surface of a phonograph record when actuated by audio-frequency signals. Also called *cutting head*.

cutting angle The angle between the vertical cutting face of the stylus and the surface of the record. It should ordinarily be 90 degrees. Deviation from this value is sometimes specified as the dig-in angle or drag angle.

cutting head A cutter.

cutting stylus The diamond, sapphire, or hard-steel tool that cuts the groove in a record during sound recording.

cutting through Cutting through the coating into the base of a recording disk, or cutting through from one groove into the next.

c-w Abbreviation for continuous wave. Same abbreviation used for noun and adjective.

cycle One complete sequence of variations in an alternating current, including a rise to a maximum in one direction, a return to zero, a rise to a maximum in the opposite direction, and a return to zero. The number of cycles occurring in 1 second is called the frequency.

cyclic Pertaining to recurring events, such as to circular motion, alternating current, or vibrating motions.

cyclically magnetized Under the influence of a magnetizing force varying between two specific limits long enough so that the magnetic induction has the same value for corresponding points in successive cycles.

cyclograph A name sometimes applied to an instrument having an optical or electron-beam system that moves in two directions under control of two variables, as in a cathode-ray oscilloscope. When dealing with periodic quantities, a closed figure or cyclogram, similar to a Lissajous figure, is produced.

cyclotron An apparatus for imparting high speeds to electrons or ions by causing them to move in semicircular paths in a magnetic field. The acceleration and the radius of travel are increased every 180 degrees owing to an electric field that alternates in synchronism with the motion of the electron. Used for bombarding nuclei of atoms to produce transmutations from one element to another and produce artificial radioactivity similar to that otherwise obtainable only with large quantities of radium.

cylindrical concave mirror A curved reflecting surface like the inside of one-half of a cylinder, used to focus light rays to a line.

cylindrical convex lens A lens having a straight surface in its longer dimension

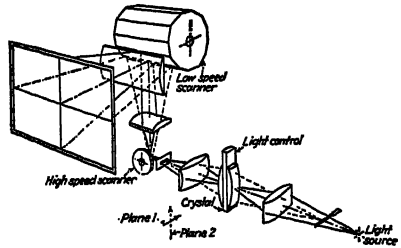

Use of cylindrical convex lenses in the Scophony television system with two motor-driven mirror wheels to provide scanning.

and a spherically curved surface at right angles to this direction, used to focus light rays to a line.

cylindrical wave A wave whose wave-front is a cylindrical surface.

cymometer Early name for a frequency-measuring instrument in which a capacitance formed by one brass tube sliding over another could be varied simultaneously with an inductance consisting of a solenoid of bare wire, arranged so that the frequency at which resonance occurred was indicated by a neon lamp and read on a scale.

D

damped impedance For an electro-acoustic transducer, the measured terminal impedance of its electric system when the attached mechanical system is blocked so that it cannot move and hence has infinite impedance. Also called *blocked impedance*.

damped oscillation Oscillation in which the amplitude of the oscillating quantity decreases with time.

damped waves Radio waves that progressively decrease in amplitude during successive cycles.

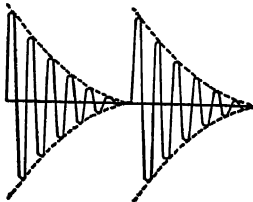

Damped waves.

dampen To place sound-absorbing material, as drapes, in a radio studio or in an auditorium to prevent echoes.

damping Reducing or eliminating oscillation or vibration by introducing friction or some other type of loss that dissipates the kinetic energy of the moving element. A vane moving in an enclosure is often used to provide damping for a meter.

damping factor The ratio of the amplitude of any one of a series of damped oscillations to that of the following one. Also called *decrement*. It is the quotient obtained, during any complete oscillation of any underdamped motion, by dividing the logarithmic decrement by the time required for the oscillation.

Daniell's cell A cell having a copper electrode in a copper sulphate solution and a zinc electrode in dilute sulphuric

acid or zinc sulphate solution, with the two solutions separated by a porous partition. It generates an essentially constant electromotive force of about 1.1 volts.

daraf The unit of elastance, which is the reciprocal of capacitance. It is the term farad spelled backward.

dark conduction Residual electrical conduction in a photosensitive substance when not illuminated.

dark discharge An electric discharge that has no visible luminosity, occurring in a gas.

dark spot Sometimes observed in a reproduced television image. Caused by the formation of electron clouds in front of the mosaic screen in the camera tube at the television transmitter.

dark-spot signal The signal existing in a television system during scanning of a dark spot by the television camera.

D'Arsonval current A comparatively strong current produced by a low-voltage high-frequency source and used in electrobiology.

D'Arsonval galvanometer A direct-current galvanometer consisting of a narrow rectangular coil freely suspended between the poles of a permanent magnet. Current sent through the coil produces the magnetic field that interacts with the permanent field and causes rotation of the coil.

D'Arsonval movement The meter movement commonly used in precision instruments for direct-current measurements. It consists essentially of a small lightweight coil of wire supported on jeweled bearings between the poles of a permanent magnet. Spiral springs provide connections to the coil and keep the coil and its attached pointer at the zero position on the

D-C VOLTAGE

meter scale. When the direct current to be measured is sent through the coil, its magnetic field interacts with that of the permanent magnet and causes rotation of the coil and pointer.

Davisson coordinates A special system of curvilinear coordinates, used in plotting the emission characteristic of a vacuum tube.

db Abbreviation for decibel.

db meter A copper-oxide rectifier-type meter having a scale calibrated to read directly in decibel values at a reference level that must be specified. Used in audio-frequency amplifier circuits of broadcast stations, public-address systems, and receiver output circuits to indicate volume level.

d-c Abbreviation for direct current. Same abbreviation used for noun and adjective.

d-c amplifier An amplifier that is capable of amplifying small variations in direct current. It generally employs direct coupling between stages, through resistors.

dcc wire Abbreviation for double-cotton-covered wire.

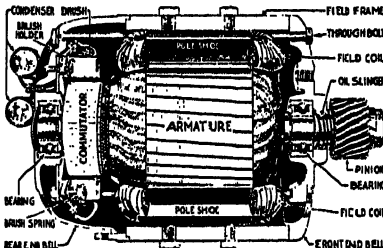

Cross-section of direct-current generator. This unit is used in a wind charger and is driven by a propeller through gears.

d-c generator A rotating electric machine that converts mechanical power into direct-current power.

d-c inserter stage The television transmitter stage that adds to the video signal a

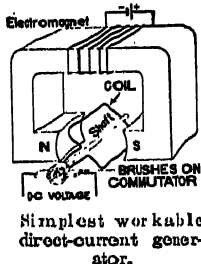

direct-current component known as the pedestal level.

d-c picture transmission Transmission of the direct-current component of the television picture signal. This component represents the background or average illumination of the over-all scene, and varies only with over-all illumination. In contrast, the alternating-current component or video signal varies with the brilliance of the small area of the scene being scanned at the moment.

d-c plate resistance A vacuum-tube value equal to the direct-current plate voltage divided by the direct-current plate current.

d-c receiver A radio receiver designed to operate from one of the direct-current power lines that are still in service in older sections of many cities. The commonest voltage is 110 volts. The circuit employed is much the same as for universal a-c/d-c receivers, with the tube filaments connected in series with a voltage-dropping resistor across the power line.

d-c resistance The resistance (opposition to current flow) offered by a circuit or body for an unvarying current. Usually called simply *resistance*.

d-c transformer 1. A device for measuring large values of direct current, in which the line current magnetizes an iron core surrounding the conductor or enclosed by a few turns of the conductor. In the air gap of the core is an armature that is driven at constant speed and is provided with brushes connected to the indicating instrument. The armature current is proportional to the magnetic field strength and hence to the line current. 2. A term sometimes applied to a rotating machine used to convert direct current from one voltage to another.

d-c transmission Transmission of a television signal in such a way that the direct-current component of the picture signal is still present.

d-c voltage Abbreviation for direct voltage. A deprecated abbreviation because it stands for direct-current voltage.

DEACCENTUATOR

deaccentuator A network, or circuit, required in a frequency-modulation receiver to offset the preemphasis action introduced at the higher audio frequencies in a frequency-modulation transmitter.

deadbeat Coming to rest without vibration or oscillation. Thus, the pointer of a highly damped meter or galvanometer moves to a new position without overshooting and vibrating about its final position. Also called *aperiodic*.

dead-center position The position in which a brush would be placed on the commutator of a direct-current motor or generator if the field flux were not distorted by armature reaction.

dead end 1. That end of a radio studio which has the greater sound-absorbing characteristics. 2. That portion of a tapped coil through which no current is flowing at a particular band-switch position.

dead room A room so thoroughly sound-proofed that practically all sound is absorbed and there is little reflection or echo.

dead short A short circuit having very low resistance.

dead spot 1. A location in which signals from a radio station are received poorly or not at all. 2. A portion of the tuning range of a receiver in which stations are heard poorly or not at all, owing to improper design of tuning circuits in the receiver.

death ray Any ray capable of killing living cells. Ultraviolet rays of certain frequencies can kill bacteria, radio waves of certain frequencies can kill insects, and X rays have still greater destructive power. From time to time, inventors have claimed great destructive effects for secret rays produced in highly concentrated beams and reported to have wavelengths in the relatively unknown region between ultraviolet radiation and X rays, but to date the claims have not been confirmed by demonstrations.

de Broglie equation An expression for the wavelength of the de Broglie wave

associated with a moving electron. It states that the wavelength is equal to Planck's constant divided by the momentum of the electron.

de Broglie wave A wave or wave group assumed in wave mechanics to be associated with an elementary moving particle such as an electron or a proton. Sometimes called *phase wave*.

debunching A space charge effect that tends to destroy the electron bunching in a velocity modulation tube.

decade box A special type of variable resistor or variable capacitor used chiefly in laboratory work. It contains two or more sections, with each section having ten times the value of the preceding section and with each section divided into 10 equal parts. Each section has a 10-position selector switch or equivalent arrangement such that the box can be set to any desired value in its range.

decade resistance box A decade box containing two or more sets of 10 precision resistors.

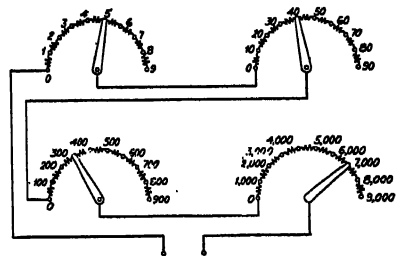
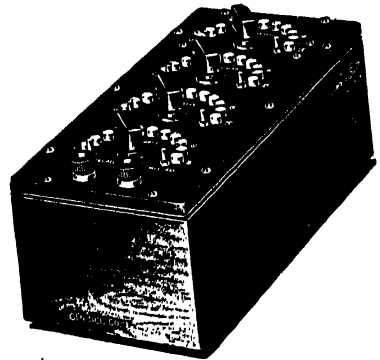

Decade resistance box and internal circuit arrangement.

deci- A prefix meaning one-tenth.

decibel A unit used for expressing the magnitude of a change in signal level or a change in sound level. One decibel is the amount that the pressure of a pure sine wave sound must be changed in order for the change to be just barely detectable by the average human ear. The amount of change in power level, expressed in decibels, is equal to ten times the common logarithm of the ratio of the two powers ($db = 10 \log P_1/P_2$).

decimal attenuator A system of attenuators so arranged that a voltage or current can be reduced decimally.

decimetric waves Electromagnetic waves having wavelengths between 0.1 and 1 meter.

declination The angle between the horizontal component of the earth's magnetic field and a line running due north and south.

declinometer An instrument for measuring magnetic declination, consisting essentially of a delicately suspended magnet and a means for measuring the angular position of the magnet with respect to true north and south.

decoupling Preventing feedback of energy from the output of a device to its input.

decoupling circuit A circuit used to prevent interaction of one circuit with another.

decoupling filter A filter used to prevent interaction of two circuits.

decoupling network A network used to prevent interaction of two circuits.

decoupling resistance A resistor, usually of high value, used to prevent interaction of two circuits.

decrement A decrease in the value of a variable quantity. When applied to damped oscillations, it is usually called *damping factor*.

decrometer An instrument for measuring the damping of a radio wave or alternating current.

deemphasis Removal of emphasis (usually of higher audio frequencies) previously introduced in a system.

deenergize To stop the flow of current in a circuit, or remove the voltage from a circuit, as by opening a switch.

definition 1. The fidelity with which a lens, television receiver, facsimile receiver, or cathode-ray oscilloscope forms an image having fine detail. When the image is sharp and has definite lines and boundaries, the definition is said to be good. 2. In facsimile, the definition in a given direction is equal to the width of the narrowest isolated line of subject copy perpendicular to that direction, for which the response of the system will just reach the steady-state value attained for a larger area of the same density.

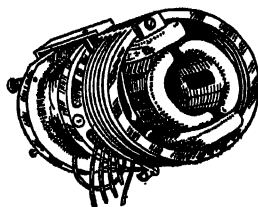

Deflecting coils for a television cathode-ray tube.

deflecting coil An inductor used to produce a magnetic field that will bend the electron beam a desired amount in the cathode-ray tube of an oscilloscope, television receiver, or television camera. Also called *deflecting yoke*.

deflecting electrode A cathode-ray-tube electrode to which a potential is applied for the purpose of moving the electron beam in a horizontal or vertical direction.

deflecting yoke A deflecting coil for a cathode-ray tube.

deflection Movement away from a position, as deflection of the pointer in a meter or deflection of the electron beam in a cathode-ray tube.

deflection factor The reciprocal of the deflection sensitivity of a cathode-ray tube. It is therefore the amount of change in the deflecting field that will

DEFLECTION SENSITIVITY

cause unit displacement of the electron beam at the screen. It may be expressed as volts per inch or deflecting coil current per inch.

deflection sensitivity The amount of displacement of the electron beam at the screen of a cathode-ray tube per unit change in the deflecting field. Usually expressed in millimeters per volt applied between deflecting electrodes or in millimeters per gauss of the deflecting magnetic field.

deflection tube A tube in which the output current is controlled by the deflection of an electron stream.

degassing The process of driving out and exhausting any gases that are occluded in the electrodes and other parts of a vacuum tube and that would not be removed by evacuation alone.

degaussing Term used to describe a means of neutralizing the magnetic field of the hull of a ship as a protection against magnetic mines.

degaussing cable A cable arranged around the hull of a ship and fed with a current of the correct value to neutralize the magnetic effect of the hull. The adjustment is made at a degaussing station equipped with underwater equipment to indicate when the resultant magnetic field has been sufficiently weakened so it will not actuate the magnetic striker of a mine.

degeneration A vacuum-tube-circuit arrangement wherein a signal is fed back from the plate circuit to the grid circuit in such a way that it is 180 degrees out of phase with the input signal, decreasing the amplification. It is used in radio-frequency circuits to improve stability by preventing oscillation, and in audio-frequency circuits to reduce distortion and noise in order to permit greater undistorted power output. Also called *inverse feedback*, *negative feedback* and *stabilized feedback*.

degenerative feedback Degeneration.

degree 1. A division identified by a whole number on a thermometer. One degree change in temperature in the centigrade system is equal to one-

hundredth of the difference in temperature between that of melting ice and boiling water, while one degree in the Fahrenheit system is equal to $\frac{1}{180}$ th of this difference in temperature. 2. The angular unit of measure. One degree is equal to a 360th part of a circle.

Deion circuit breaker A circuit breaker in which the arc that forms on breaking is magnetically blown into a stack of insulated copper plates, giving the effect of a large number of short arcs in series. Each arc becomes almost instantly deionized when the current drops to zero in the alternating-current cycle, and the arc cannot re-form.

deionization potential The potential at which the ionization of the gas within a gas-filled tube ceases and conduction stops.

deionization time The time required for the control grid of a gaseous tube to regain control after plate current has been interrupted.

delay distortion That form of distortion in which the time of transmission (the delay) varies with frequency in the desired transmission range. It occurs when the phase angle of the transfer impedance with respect to two chosen pairs of terminals is not linear with frequency.

delayed automatic volume control An automatic-volume-control circuit that acts only on signals above a certain strength. It thus permits reception of weak signals even though they may be fading, whereas normal automatic volume control would make the weak signals weaker. The delayed action is obtained by introducing a bias voltage that is in series with and opposes the automatic-volume-control voltage.

delay equalizer A corrective network design to make the phase angle of the transfer impedance, with respect to two chosen pairs of terminals, substantially linear with frequency within a desired range. It thus makes the time of transmission or delay substantially constant in that frequency range.

Dellinger effect Complete fade-outs in short-wave reception due to rapid changes in ionosphere layers during solar eruptions.

delta Greek letter Δ .

delta circuit A combination of three resistors or other circuit components connected in series to form a triangle like the Greek letter delta Δ . Also called *mesh circuit*.

delta connection Connection of a three-phase system so that the phases form a triangle like the Greek letter delta Δ .

delta matching transformer A method of matching an open-wire transmission line to a half-wave antenna by spreading out the upper ends of the line and connecting them directly to the antenna to form a triangle like the Greek letter delta Δ . The antenna is not cut at its center.

delta rays Electrons emitted by substances when bombarded by alpha particles.

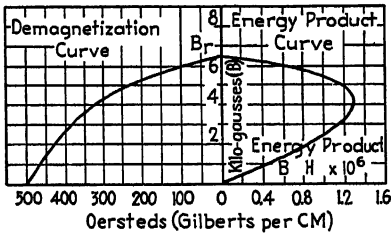

Demagnetization curve and corresponding energy product curve for one type of Alnico permanent-magnet material.

demagnetization curve A portion of the hysteresis loop of a magnetic material, giving practically all the required characteristics of the material for use as a permanent magnet. The curve shows the peak value of residual magnetism (known as residual induction B_r) and the manner in which magnetization reduces to zero as demagnetizing force H is applied. The energy product curve, usually shown also, is obtained by plotting the product of the values of B and H for each point on the demagnetization curve.

demagnetize To remove magnetism from a magnetized object, as by heat-

ing or placing it in a strong alternating field.

demand factor The ratio of the average load on a power plant or system during a given period of time to the maximum power demand during that period.

demand meter A device that indicates the demand or maximum demand of current or power drawn by connected loads.

demand recorder An instrument that records graphically the average value of the load in a circuit during successive short periods.

demodulation The process by which a modulated wave is so operated upon that a wave is obtained having substantially the characteristics of the original audio or other modulating wave. Detection, one form of demodulation, separates the desired audio or picture signal from the carrier signal.

demodulator A detector for radio-frequency signals. It rectifies the incoming modulated carrier frequency and separates the carrier from the desired modulation signal.

demountable tube A high-power radio tube having a metal envelope with porcelain insulation. It can be taken apart for inspection and for renewal of electrodes.

densitometer An instrument used to measure the density or opacity of a material. In a photoelectric densitometer, the amount of light transmitted by the material is measured with a photoelectric cell or phototube.

density 1. A measure of the concentration of matter in a material, in which case density is equal to weight divided by volume. 2. A measure of the light-reflecting or light-transmitting properties of an area. It is expressed as the common logarithm of the ratio of incident light to transmitted or reflected light. 3. A measure of the closeness of any space distribution, as of magnetic flux. Flux density is the number of magnetic lines of force per unit cross-sectional area. Current

DEPOLARIZER

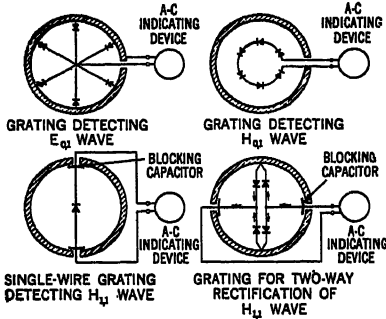

Detecting gratings for reception of waves in circular wave guides, using crystal detectors that are fixed into the meshes of a conformal wire grating and feed an alternating-current meter or other indicating device.

density is the number of amperes per unit cross-sectional area.

depolarizer A chemical used in some primary cells to prevent polarization (formation of bubbles of hydrogen) at the positive electrode.

deposition Depositing a coating on a surface, as by electroplating.

depth The limits, with respect to distance from the camera, within which objects may be photographed with satisfactory definition under a given set of conditions.

depth of cut The depth to which the stylus penetrates the recording lacquer of a recording disk.

depth of focus The distance range in the direction away from a lens over which objects are sufficiently in focus for the type of service involved.

derived units Units that are derived from fundamental units in a system by application of physical laws.

dermal resistance Skin resistance.

detail 1. The opposite of contrast. The presence of minute detail in an image means an absence of deep contrast. 2. In facsimile, the square root of the ratio between the number of scanning lines per unit length and the definition in the direction of the scanning line.

detecting grating A conformal wire grating equipped with one or more crystal detectors and placed in a wave guide for reception of waves.

detection Any process of operation on a modulated signal wave by which the signal imparted to it in the modulation process is obtained.

detectophone An instrument for listening to conversations secretly, without the knowledge of the speakers. It consists essentially of a high-sensitivity nondirectional microphone concealed in the room and connected to an amplifier and headphones in a near-by room. Sometimes the microphone feeds into a small radio transmitter or a wired wireless transmitter broadcasting over power lines, permitting the listener to be farther away.

detector The radio-receiver stage at which demodulation takes place. The detector in a tuned-radio-frequency receiver separates the audio-frequency

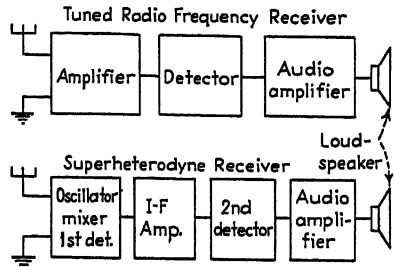

Detector positions in receivers.

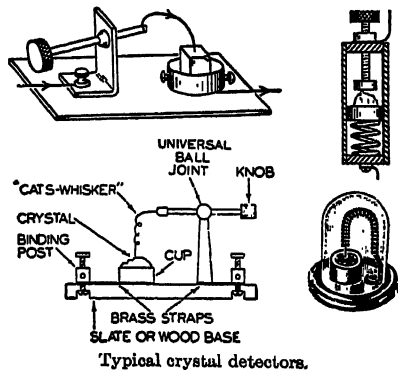

Typical crystal detectors.

signal from the radio-frequency carrier signal. The second detector in a superheterodyne receiver separates the audio-frequency signal from the intermediate-frequency carrier signal. (The first detector in a superheterodyne receiver is not a true detector, because it merely changes the frequency of the carrier signal from the radio-frequency value to the intermediate-frequency value.)

detune To change the inductance or capacitance of a tuned circuit so that its resonant frequency is different from the incoming signal frequency.

deuterium The hydrogen isotope having an atomic weight or mass of approximately 2, sometimes called *heavy hydrogen*.

deuteron The nucleus of deuterium, a hydrogen isotope having an atomic weight or mass of approximately 2.

developmental broadcast station A station licensed to carry on development and research for the advancement of broadcast services.

d-f Abbreviation for direction-finding and direction finder. Same abbreviation used for noun and adjective.

diadochokinetic Pertaining to alternating and diametrically opposite muscular actions, such as the flexion and tension of a muscle. Electronic instruments such as the electrokymograph are used to study these movements.

diagram A plan or layout showing the construction or electrical connections of a piece of equipment, such as a schematic circuit diagram, a pictorial wiring diagram, or a block diagram.

dial Any means for indicating the value to which a control has been set. Thus, the tuning dial of a radio receiver indicates the frequency to which the receiver has been tuned.

dial cable Braided cord or flexible wire cable used to make a

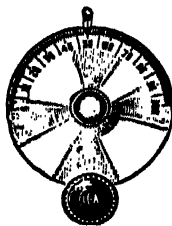

Friction-drive dial.

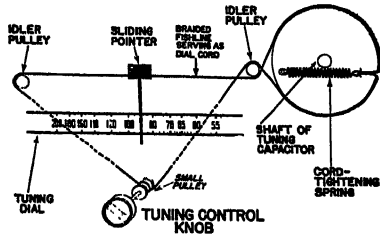

Dial cord layout for slide-rule type of tuning dial.

tuning knob control the position of a pointer that indicates the frequency to which a radio receiver is tuned.

dial cord The braided cotton or silk cord used as a dial cable.

dial light The small lamp that illuminates the tuning dial of a radio receiver. Also called *pilot lamp*.

dial telephone system A telephone system in which telephone connections between customers are ordinarily established by electric and mechanical apparatus controlled by manipulations of a dial operated by the calling party.

diam Abbreviation for diameter.

diamagnetic Having a magnetic permeability less than 1 and hence less than that of a vacuum. Examples are bismuth and antimony. If brought near a magnet in air, diamagnetic materials will be repelled, though the effect is not very pronounced. They tend to position themselves at right angles to magnetic lines of force instead of along the lines of force.

diamond antenna A horizontal rhombic antenna having four conductors forming a diamond or rhombus.

diaphragm 1. A thin flexible sheet that can be moved by sound waves as in a microphone, or can produce sound waves when moved as in a loudspeaker. 2. An adjustable opening used in photographic and television cameras to reduce the effective area of a lens in order to increase the depth of focus. 3. A porous or permeable membrane, usually flexible, separating anode and cathode compartments of an electrolytic cell from each other or from an

DIAPHRAGMLESS MICROPHONE

intermediate compartment for the purpose of preventing admixture of anolyte and catholyte.

diaphragmless microphone A microphone having no mechanical vibrating system. Instead, sound waves act directly on a flame, arc, glow discharge, or the ionized space between a Nernst glower and a cold electrode.

diathermic coagulation Passing of high-frequency currents through the body to produce albumin coagulation.

diathermic surgery The use of current at high frequencies for performing operations by cutting flesh with an electric arc.

diathermy The therapeutic use of a high-frequency current to generate heat within some part of the body. Frequencies used range from several hundred thousand cycles up to millions of cycles.

diathermy machine A radio-frequency oscillator, sometimes followed by radio-frequency amplifier stages, used to generate high-frequency currents for therapeutic treatments.

Dictaphone reception Recording of high-speed radiotelegraph signals with a Dictaphone or phonograph, which can afterward be run slower for reading or copying the message.

Dictograph An instrument for recording conversations secretly, without the knowledge of the speakers. It consists essentially of a high-sensitivity nondirectional microphone concealed in a room and connected to an amplifier and recorder in an adjacent room. Sometimes the microphone feeds into a small radio transmitter or a wired wireless transmitter broadcasting over power lines, to permit placing the recorder farther away.

dielectric The insulating material between the plates of a capacitor; generally air, mica, paper, oil, or glass. All insulating materials are dielectrics in that they are capable of sustaining an electric field and undergoing electric polarization. A dielectric material has the property that the energy required

to establish an electric field is recoverable, in whole or in part, as electric energy.

dielectric absorption 1. That property of an imperfect dielectric as a result of which there is an accumulation of electric charges within the body of the material when it is placed in an electric field. 2. The occurrence of peaks in the curve of dielectric loss factor plotted against temperature or frequency, due to absorption of energy in a nonuniform manner by the dielectric.

dielectric constant That property of a dielectric material which determines how much electrostatic energy can be stored per unit volume when unit voltage is applied. In effect, it is the ratio of the capacitance of a capacitor filled with a given dielectric to that of the same capacitor having only a vacuum as dielectric. The dielectric constant of air is 1, while that of glass varies between 4 and 8. Also known as *permittivity* and *specific inductive capacitance*.

dielectric current When an isotropic dielectric is in a changing electric field, the dielectric current flowing at any instant through any surface can usually be considered as having four components: (1) displacement current, (2) absorption current, (3) conduction current, (4) decaying conduction current. Of these, the displacement current is the only one present in every dielectric.

dielectric fatigue The property of some dielectrics in which resistance to disruption decreases after a voltage has been applied for a considerable time.

dielectric guide A class of wave guides consisting of a dielectric cylinder surrounded by air. It is capable of propagating electromagnetic waves through its interior much as sound waves travel through a speaking tube. Dielectric guides have little practical use owing to the high losses in solid dielectrics. Conducting guides, the other class, are used extensively.

dielectric heating Use of radio-frequency energy to heat nonmetallic

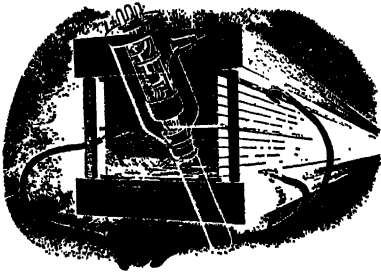

Dielectric heating speeds the gluing of wood. Radio-frequency energy, produced by power tubes like that shown in phantom, is applied to metal plates between which the wood is placed.

materials such as wood, plastics, or chemicals. The heat is produced by molecular friction.

dielectric hysteresis Lagging of the electric field produced by application of an alternating voltage to a dielectric. It causes a dielectric hysteresis loss analogous to that of magnetic hysteresis.

dielectric loss The time rate at which electric energy is transformed into heat in a dielectric that is being subjected to a changing electric field.

dielectric phase angle The angular difference in phase between the alternating voltage applied to a dielectric and the resulting alternating current.

dielectric power factor The cosine of the dielectric phase angle.

dielectric separator An apparatus for separating minerals from other materials on the basis of differences in the dielectric constants of the materials to be separated. Crushed ore is suspended in a liquid having a dielectric constant intermediate between those of the materials to be separated, and the mixture is passed between electrodes connected to a moderately high alternating-voltage source. The mineral of higher dielectric constant adheres to the electrodes, and the rest of the material passes on.

dielectric strength The maximum potential gradient that a dielectric material can withstand without rupture. Also called *electric strength* and *insulating strength*.

dielectric susceptibility The polarization in a material per unit electric intensity. When k is dielectric susceptibility and K is the dielectric constant, $k = (K - 1)/4\pi$.

dielectric tests Tests involving application of a voltage higher than the rated voltage for a specified time in order to determine the adequacy against breakdown of insulating materials and spacings under normal conditions.

dielectric wire A wave guide consisting of a solid dielectric rod of the desired length, made of a plastic material, glass, or other insulating material. Used for transmission of radio waves over short distances between parts of a circuit at ultrahigh frequencies.

difference of potential The voltage between two points.

differential galvanometer A galvanometer having two similar but opposed coils whose currents tend to neutralize each other. A zero reading is obtained when the currents are equal.

differential instrument A galvanometer or other measuring instrument having two circuits or coils, usually identical, through which currents flow in opposite directions. The difference or differential effect of these currents actuates the indicating pointer.

differential microphone A double-button carbon microphone. Extra sensitivity is obtained by using two carbon elements, one on each side of the diaphragm, so that a decrease in resistance of one button is accompanied by an increase in resistance of the other button.

differential permeability The ratio of a small increase in normal magnetic induction to the increase in magnetizing force when these changes are vanishingly small.

differential relay A relay that functions by reason of the difference between two quantities of the same nature, such as two currents or two voltages.

differential winding A coil winding arranged in such a way that its mag-

DIFFERENTIAL-WOUND FIELD

netic field, and hence its effect, is opposite to that of a near-by coil.

differential-wound field A type of motor or generator field having both series and shunt coils that are connected to oppose each other.

differentiating circuit A circuit in which the output voltage is proportional to the rate of change of the input voltage.

diffraction The bending of waves such as light, radio, or sound waves around an obstacle.

diffraction grating A screen having 1,000 to 50,000 lines per inch on a polished metal or glass surface, used to produce a spectrum by interference between different colors of light passing through or reflected by the grating. Often called *grating*.

diffuse In all directions, not in any sharply defined path. Applicable to reflection, refraction, or transmission of light and other waves.

diffuse reflection Reflection of light, sound, or radio waves from a surface so fine and even that reflected rays are distributed in all directions in a definite mathematical manner according to the cosine law.

diffuse sound Sound having essentially uniform energy flux in all directions in a particular region.

diffusion Scattering.

diffusion pump A type of vacuum pump in which mercury vapor or other heavy molecules in a stream or jet carry gas molecules before them. Mercury-vapor diffusion pumps are extensively used in producing high vacuums in electronic tubes.

dig-in angle A stylus cutting angle such that the point is driving into the coating. It is the opposite of drag angle.

diheptal base A 14-pin base used for cathode-ray tubes.

dimmer An adjustable resistance or rheostat used to change the brilliance of one or more lamps.

diode A vacuum tube having two electrodes, namely a cathode and an anode.

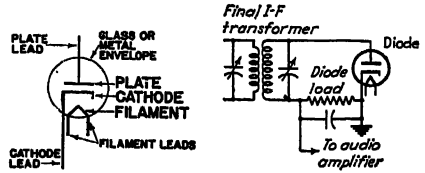

Diode symbol.

Diode detector.

diode detector A detector circuit employing a diode vacuum tube as the rectifying element.

diode limiter A peak-limiting circuit employing a diode that becomes conductive when signal peaks exceed a predetermined value.

diode peak detector A diode vacuum tube used in a circuit to indicate when audio peaks at the transmitter exceed a predetermined value.

diode-pentode A vacuum tube having a diode and a pentode in the same envelope.

diode-triode A vacuum tube having a diode and a triode in the same envelope.

diopter A unit used chiefly for measuring the power of spectacle lenses. The power in diopters is equal to the reciprocal of the focal length in meters. Thus, a lens having a focal length of 50 centimeters (0.5 meter) has a power of 2 diopters.

diplex operation Simultaneous transmission or reception of two signals using a common feature, such as a single antenna or a single carrier.

diplex transmission Simultaneous transmission of two signals by means of some common feature, such as a single carrier or a single antenna.

dipole 1. A dipole antenna. 2. A system composed of two equal electric charges of opposite sign, separated by a finite distance, such as the nucleus and the orbital electron of a hydrogen atom.

dipole antenna An antenna one-half wavelength long.

direct-arc furnace A furnace in which the heat-producing arc is formed between the electrodes and the charge.

direct capacitance A capacitance value equal to the charge produced on a conductor divided by the voltage between that conductor and another conductor.

direct coupling The association of two circuits by means of a self-inductance, capacitance, or resistance common to both circuits.

direct current A unidirectional current (flowing in one direction at all times) in which the value is essentially constant. Also called *continuous current*.

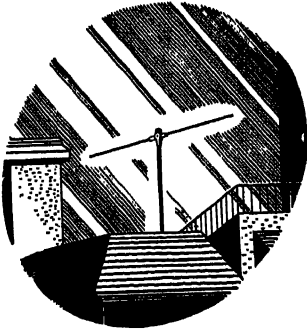

Dipole antenna for television and frequency-modulation reception.

direct drive A direct shaft-to-shaft connection between the driving and driven parts of a rotating system, avoiding the use of belts and pulleys.

direct grid bias The direct voltage used to make the control grid of a vacuum tube negative with respect to the cathode and provide the desired operating point. Commonly called *grid bias*.

direct inductive coupling The association or linking of one circuit with another by means of inductance that is common to the two circuits. Often obtained by connecting one circuit directly to a tap on a coil in another circuit.

directional antenna An antenna which, due to its construction, radiates or receives radio waves better in some directions than in others.

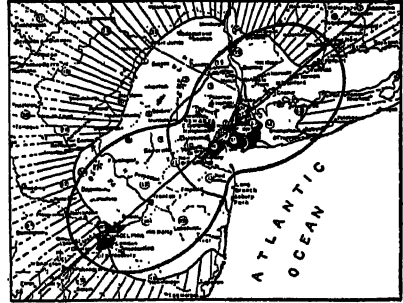

Directional radiation pattern.

directional characteristic An expression of the variation of the behavior of an electroacoustic transducer with respect to direction.

directional pattern A radiation pattern for an antenna, indicating the intensity of the radiation field of a transmitting antenna at a given distance away from the antenna in all directions. In the case of a receiving antenna, it indicates the response of the antenna to a signal having unit field intensity and arriving from different directions.

directional relay A relay that functions in conformance with the direction of voltage, power, phase rotation, etc.

direction finder A radio receiving device used to determine the direction along which radio waves are arriving from a transmitter.

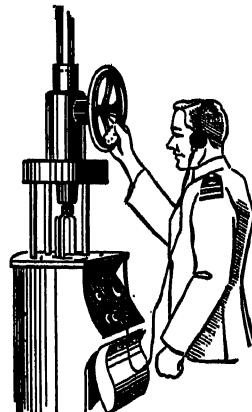

Operating position of a marine radio direction finder.

DIRECTION-FINDER DEVIATION

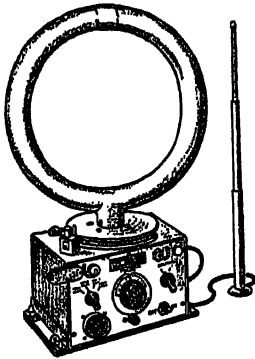

Unilateral direction finder, using a directional rotating loop and a nondirectional vertical antenna.

direction-finder deviation The difference between the observed radio bearing obtained with a direction finder and the true bearing of the transmitter.

direction-finding station A shore radio station having equipment for determining the direction of arrival of radio waves from ships or aircraft.

directivity That characteristic of an antenna which makes it radiate or receive more energy in some directions than in others.

directly heated cathode A filament cathode that carries its own heating current, as distinguished from an indirectly heated cathode.

director A parasitic antenna located in front of the radiating antenna so that radiation will add in the forward direction.

direct resistance-coupled amplifier An amplifier in which the plate of one stage is connected either directly or through a resistor to the control grid of the next stage, with the plate load resistor being common to both stages. Used to amplify small changes in direct current.

direct scanning A scanning method in which the subject is illuminated at all times and only one elemental area of the subject is viewed at a time by the television camera.

direct voltage A voltage that forces electrons to move through a circuit

in the same direction continuously, thereby producing a direct current.

direct wave A radio wave that travels directly from transmitting antenna to receiving antenna, without being reflected or refracted along the way.

discharge 1. Converting the chemical energy of a battery into electrical energy by allowing the battery to send current through a circuit. 2. Releasing the energy stored in a capacitor by connecting together the capacitor terminals.

discharge key A device for switching a capacitor suddenly from a charging circuit to a load through which it can discharge.

discharge lamp A lamp in which light is produced by the luminescence of a gas or vapor at low pressure, through which an electric discharge is passed between suitable electrodes. Fluorescent materials are sometimes used on the inner surface of the glass envelope to increase the illumination, as in ordinary fluorescent lamps.

discharge tube An evacuated enclosure containing a gas at low pressure, through which current can flow when sufficient voltage is applied between metal electrodes in the tube. This is a general term used for all electronic tubes in which current flow is due chiefly to ionization of a gas or vapor.

discharging current 1. The correct rate at which a particular battery should be discharged. 2. The current provided by a battery during discharge. 3. The current obtained by discharging a capacitor.

disconnect To open a circuit by removing wires or connections, as distinguished from opening a switch to stop current flow.

discontinuity A break in the conductivity of an electric circuit, or a break in continuity or sequence.

discriminator That stage of a frequency-modulation receiver which converts frequency-modulation signals directly into audio-frequency signals,

DISPLACEMENT

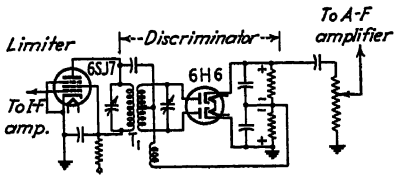

Discriminator circuit of a frequency-modulation receiver.

or a similar stage used in an automatic-frequency-control system to convert frequency changes into corresponding voltages.

disintegration The emission of alpha or beta particles by a radioactive atom.

disintegration of filament Projection of particles from the filament of an incandescent lamp or filament-type vacuum tube, causing blackening of the glass bulb.

disintegration product The changed substance that remains after loss of electrons due to radioactivity.

disk A complete phonograph record or the blank used in a sound recorder.

disk recording Recording of sounds on a disk.

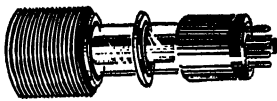

Disk-seal tube.

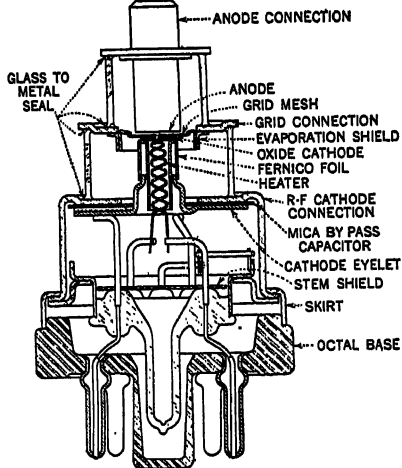

Details of type 2C40 disk-seal tube.

disk-seal tube An electronic tube having its electrodes arranged in parallel planes or layers, with glass and metal fused together as a rigid unit capable of withstanding the severe jolts encountered in military applications. The coplanar electrode design gives very low interelectrode capacitance along with high power output at extremely high frequencies. The generic term for tubes of this type is megatron, and a popular designation is *lighthouse tube*.

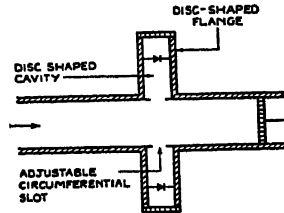

Disk-shaped cavity used with tuned resonating cavity as a wave-guide termination for reception purposes. Wave energy is absorbed by the detecting crystals and fed by them to sound or television receivers or other equipment.

disk-shaped cavity An arrangement for receiving and detecting waves in a wave guide. It may consist of two disk-shaped flanges inserted in the guide and short-circuited at their ends by a circular metal band or ring, or may consist of one disk-shaped flange bent over the guide to form a coaxial cavity that is closed by a washer-shaped piston surrounding the original guide. The resulting cavity, when tuned, serves to attract the patterns of loops of force proceeding along the guide, and causes them to transfer energy to detecting crystals appropriately located in the cavity.

dispersion The process of separating or sorting an emission into components usually having different directions, in accordance with frequency, energy, or some other characteristic. A prism or diffraction grating disperses white light. A magnetic field sorts electrons having different velocities.

displacement 1. A change in a medium, as that produced by a sound wave or electromagnetic wave. 2. A vector

DISPLACEMENT CURRENT

associated with the electric field in a dielectric.

displacement current That component of dielectric current which is proportional to the rate of change of displacement flux through any surface under consideration.

disruptive discharge A sudden and large increase in current through an insulating medium due to complete failure of the medium under electrostatic stress.

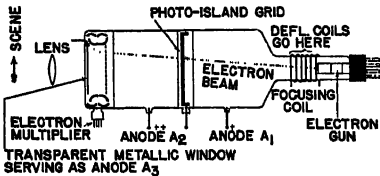

Farnsworth storage-type dissector tube for television cameras.

dissector tube A cathode-ray television camera tube developed by P. T. Farnsworth.

dissipation A waste of energy, as by the production of undesired heat in a circuit.

dissipative system A system that does not conserve energy.

dissociation theory The theory by which electrolytic conduction is explained by assuming that substances in solution are dissociated into positive and negative ions that travel in opposite directions carrying their respective charges.

distortion 1. A change in the waveform of a signal, occurring in a transducer or transmission medium. The principal causes of distortion are nonuniform transmission at different frequencies, a nonlinear relation between input and output at a given frequency, and phase shift that is not proportional to frequency. Different component frequencies may be transmitted with different speeds or unequal attenuation, thereby changing the waveform. 2. An imperfection in an optical image due to spherical aberration or other defects in the optical system.

distress frequency Any frequency allotted to distress calls, generally by international agreement. For ships at sea and aircraft over the sea, it is 500 kilocycles.

distress signal A radio signal identifying a message pertaining to the safety of life or property at sea or in the air.

distributed capacitance Capacitance distributed between wires, between parts, or between conducting elements and the ground, as distinguished from capacitance concentrated or lumped in a capacitor. Usually applied to the capacitance between the turns of a coil.

distributed constants Constants such as resistance, inductance, or capacitance that exist along the entire length or area of a circuit, as distinguished from constants concentrated in circuit components.

distributed inductance The inductance that exists along the length of a conductor, as distinguished from inductance concentrated or lumped in an inductor.

distribution control The television receiver control that varies the amount of correction applied to the saw-tooth scanning wave in order to provide the desired linear scanning of lines.

distributor A rotating switch used in automotive ignition systems to apply the high voltage of the ignition coil to the spark plugs at correct times and in correct sequence.

disturbance An interfering or noise signal affecting radio, television, or facsimile reception.

diurnal variation The very small variation that occurs daily in the direction of the magnetic north pole.

divergent beam A beam consisting of rays that spread out (diverge) from a point.

diversity reception Reception of radio signals with a diversity system.

diversity system A system of radio communication in which a single

received signal is derived from a combination of, or selection from, a plurality of transmission channels or paths. The system employed may include space diversity, polarization diversity, or frequency diversity. The diversity principle takes advantage of the fact that fading characteristics of a given signal generally vary widely, at any given instant, at different receiving antenna locations.

dividing network A coupling system so arranged that at low audio frequencies power is delivered to a low-frequency loudspeaker, while at high frequencies it is delivered to a high-frequency loudspeaker. The frequency at which the power delivered to two loudspeakers is equal is termed the *crossover frequency*.

dog house The structure placed at the base of a transmitting antenna tower to house antenna-tuning equipment.

Doherty amplifier

An amplifier circuit in which one tube supplies the unmodulated carrier current, with its output being reduced to supply negative peaks of modulation, and a second tube supplies approximately half the positive peaks of modulation and lowers the load impedance of the first tube so it will supply the other half of the positive peaks. This arrangement gives increased power output and increased efficiency.

dolly A wheeled truck upon which a television camera is mounted to permit gradual controlled movement of the camera in any desired direction.

domestic count The method used for counting the number of words in a domestic telegram. It includes only the words in the text except when the sender makes the address or signature abnormally long.

dominant station A standard class I broadcast station operating on a clear channel.

dominant wave The guided wave that has the lowest cutoff frequency. It is the only wave that will carry energy when the excitation frequency is between the lowest cutoff and the next higher.

doorknob tube A doorknob-shaped tube designed for use in ultrahigh-frequency circuits. Characterized by short electron transit time due to the close spacing of the electrodes and low interelectrode capacitance due to the small size of the electrodes.

Doppler effect The apparent change in the frequency of a sound wave reaching an observer, due either to motion of the source toward or away from the observer, to motion of the observer, or both.

dosage A term used in radiology, equal to the product of the intensity of the X rays and the duration of the exposure.

dosage meter An instrument used to estimate the quantity of X-ray radiation for the purpose of determining the duration of exposure when using X rays for therapy. Also called *dosimeter* and *intensimeter*.

dosimeter A dosage meter.

dot-cycle One cycle of the periodic wave formed by a succession of dots in telegraphic communication, consisting of one dot and one spacing interval.

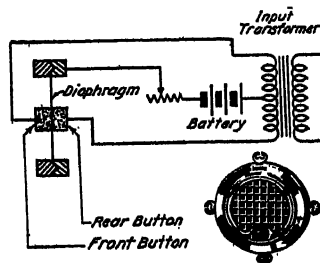
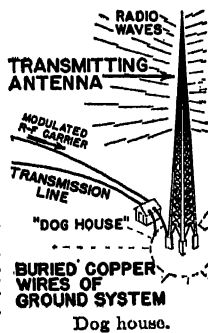

Double-button carbon microphone—example and circuit.

DOUBLE-BUTTON CARBON MICROPHONE

double-button carbon microphone A carbon microphone having two buttons or containers for carbon granules, one on each side of the diaphragm, so as to give twice the resistance change obtainable with a single button.

double-concave lens A lens having both sides curved inward, so the center is the thinnest part. It causes light rays to diverge.

double-convex lens A lens having both sides curved outward, so the center is the thickest part. It causes light rays to converge.

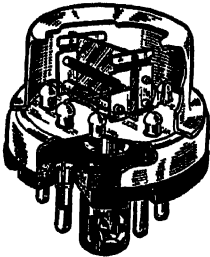

Double-diode (type 6H6) all-metal tube.

double diode A vacuum tube having two diodes in the same envelope. Also called *duodiode*.

double-grid tube A tube having two grids. A tetrode.

double modulation A method of modulation in which a carrier wave is first modulated with the desired intelligence, and the resulting modulated wave is then used to modulate a second carrier having a higher frequency.

double-pole switch A switch that simultaneously changes connections in two separate circuits or in both sides of the same circuit.

doubler A vacuum-tube circuit in which the plate circuit is tuned to twice the frequency of the grid circuit.

double refraction A phenomenon observed in certain crystals, in which light passing through is separated into two components that are polarized at right angles to each other, have different velocities within the crystal, and generally take different directions.

These components are termed the ordinary ray and the extraordinary ray.

double-sideband transmission That method of transmitter operation in which both bands of frequencies produced by the process of modulation are transmitted.

double-spot tuning In a superheterodyne receiver, the reception of a given station at two different local oscillator frequency values: (1) with the local oscillator adjusted above the incoming signal frequency by the intermediate-frequency value, and (2) with the local oscillator adjusted below the incoming signal frequency by the intermediate-frequency value. Also called *repeat point*.

double superheterodyne A superheterodyne receiver having two first detector stages. The incoming signal is combined with the local oscillator signal in the first tube to produce a preliminary intermediate-frequency value, and this in turn is combined in the second tube with the same local oscillator signal to produce the final intermediate-frequency value. The arrangement is used in some frequency-modulation receivers to obtain high gain along with stabilized operation at ultrahigh frequencies.

doublet 1. A system of two equal, oppositely charged particles close together. **2.** Two lenses of different focal lengths, combined to reduce distortion. **3.** A doublet antenna.

doublet antenna An antenna short enough, compared with a wavelength, to be considered as having uniform current throughout its length.

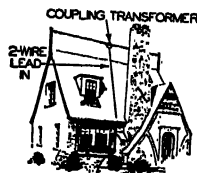

Short-wave doublet antenna installed on the roof of a house for an all-wave broadcast receiver, and doublet antenna made from rigid metal pipes for television and frequency-modulation reception.

double-throw switch A switch that permits connecting one circuit terminal to either of two other circuit terminals.

double triode A vacuum tube having two triodes in the same envelope. Also called *duotriode*.

down lead The wire that connects an antenna with a transmitter or receiver. Usually called *lead-in*.

Dow oscillator An electron-coupled oscillator circuit.

dpt Abbreviation for double-pole double-throw. Applying to a switch having six terminals and used to connect one pair of terminals to either of two other pairs of terminals.

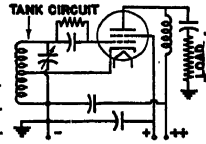

Dow oscillator circuit.

dpst Abbreviation for double-pole single-throw. Applying to a switch having four terminals and used to connect or disconnect two pairs of terminals simultaneously.

drag angle A stylus cutting angle such that the point drags during recording instead of being at 90 degrees to the record surface. It is the opposite of dig-in angle.

drag-cup motor A small high-speed two-phase alternating-current electric motor having a two-pole two-phase stator with phases 90 degrees apart, and a rotating element consisting only of an extremely light metal cup attached to a shaft rotating on ball bearings. Reversal is accomplished by reversing the connections to one phase. Used in applications requiring quick-starting, stopping, and reversal characteristics.

drift space The distance between the buncher and catcher in a velocity-modulation tube. The modulation of the electron velocities causes the electron beam to form into a bunch while traversing this drift space.

drift speed The average speed at which electrons or ions progress through a medium.

drive belt A belt used to transmit power from the driving motor to the turntable in a recorder, phonograph, or other machine.

drive holes Holes spaced around the center hole of a recording disk to engage a drive pin in the turntable, preventing the disk from slipping during recording.

driven element In an antenna array, any element that receives power directly from the transmitter.

drive pin A projecting rod positioned near the center pin of a phonograph, used with a two-hole phonograph disk to prevent the record from slipping on the turntable during recording.

driver stage The amplifier stage just ahead of a high-power audio-frequency output stage.

driver tube The tube used in a driver stage.

driving-point impedance For any pair of terminals of a network, the ratio of an applied voltage to the resultant current at these terminals when all terminals are terminated in any specified manner.

drop Voltage drop, as that due to current flow through a resistance or impedance.

drop out The maximum current, voltage, power, or other value at which a relay will release from its energized position.

drop-out current The value to which relay coil current must be reduced after the relay is closed in order to release the armature and open the relay contacts.

dropping resistor A resistor used to decrease the voltage in a circuit.

drum armature The ordinary type of armature used in rotating machines, having axial active wires rotating through a magnetic field in which the lines of force are chiefly radial.

drum speed In facsimile, the number of scanning lines per minute.

DRUM SWITCH

drum switch A switch consisting of a rotating drum having contacts that pass under spring strips fastened to an insulated support. Used for complex circuit changes.

dry battery A series, parallel, or series-parallel arrangement of dry cells in a single housing to provide desired voltage and current values.

dry cell A cell in which the electrolyte is in the form of a jelly and is absorbed in a porous medium, or is otherwise restrained from flowing. A dry cell is completely portable, and its electrolyte is nonspillable. The commonest form, having a positive electrode of carbon and a negative electrode of zinc in an electrolyte of sal ammoniac paste, is used extensively in radio batteries.



Dry cell.

dry-disk rectifier A rectifier consisting of disks of metal and other material in contact under pressure, such as a copper-oxide rectifier or a selenium rectifier.

dry electrolytic capacitor An electrolytic capacitor in which the electrolyte is a paste rather than a liquid.

dsc wire Abbreviation for double-silk-covered wire.

dual-automatic radio compass An arrangement of two automatic radio compasses feeding into a dual azimuth indicator having two pointers, each indicating the direction to a different radio station. The complete bearing is thus visible to the pilot at all times, eliminating the need for tuning to one station after another to obtain a radio fix.

dual capacitor Two capacitors in a single housing.

dual-diversity receiver A radio receiver designed to receive signals from two different receiving antennas and use whichever signal is the stronger at each instant, in order to offset fading. In one arrangement, two identical radio-frequency systems, each with

its own antenna, feed a common audio-frequency channel. In another arrangement, a single receiver is changed over from one antenna to the other by electronic switching at a rate fast enough to prevent loss of intelligibility.

dual modulation The process of modulating a carrier wave with two different types of modulation, as amplitude and frequency modulation, so as to transmit two different types of intelligence or two messages on one radio channel.

dubbing Copying a recording by playing it and feeding the resulting audio-frequency signal into a sound recorder.

duct A pipe or tubular runway for power or telephone wires, or for guiding ultrahigh-frequency radio waves.

Duddel arc A direct-current electric arc that generates an audio-frequency current and corresponding sound waves when a coil and capacitor are connected in parallel with the arc, giving a musical tone. Also called *singing arc*.

dummy antenna A resistor or other device that duplicates the electrical characteristics of a particular antenna but does not radiate an appreciable amount of energy. Used chiefly for testing and adjusting transmitters. Sometimes called *artificial antenna*.

duodiode A vacuum tube having two diodes in the same envelope. Also called *double diode*.

duodiode-pentode A vacuum tube having two diodes and a pentode in the same envelope.

duodiode-triode A vacuum tube having two diodes and a triode in the same envelope.

duolateral coil A coil having a special crisscross or honeycomb winding to reduce distributed capacitance.

duotriode A vacuum tube having two triodes in the same envelope. Also called *double triode*.

duplex operation The operation of associated transmitting and receiving

DYNAMIC PLATE RESISTANCE

apparatus at one location in conjunction with associated transmitting and receiving apparatus at another station in which the processes of transmission and reception are simultaneous.

duplex system A telegraph system that affords simultaneous independent operation in opposite directions over the same channel.

duplex tube A combination of two vacuum tubes in one envelope.

dural shank A duralumin shank commonly used on a sapphire or stellite cutting stylus.

duralumin An alloy containing 95.5 parts aluminum, 3 parts copper, 1 part manganese, and 0.5 part magnesium. It is comparable in strength to soft steel.

dust core A pulverized iron core for use in radio-frequency coils, consisting of extremely fine iron particles mixed with a binding material.

duty cycle 1. The cycle of starting, running, and stopping operations that a motor or other equipment on intermittent duty performs. 2. In radar, the ratio of pulse duration time to pulse repetition time, which is the same as the ratio of average power to peak power in a pulse.

DX Distance, as used in connection with reception of, or communication with, distant radio stations.

dynamic Pertaining to forces producing motion or some other form of action, as opposed to static (without motion) and potential (ability to produce motion).

dynamic braking A system of electric braking in which the traction motors are used as generators, thereby utilizing the kinetic energy of the vehicle to exert a retarding force. The energy may be returned to the power-supply system as in regenerative braking, or may be dissipated as heat in resistors (resistance braking).

dynamic characteristic A graph showing actual operating characteristics of a

vacuum tube. It usually shows how alternating plate current varies with alternating grid voltage.

dynamic loudspeaker A loudspeaker in which the coil carrying the audio-frequency current is attached to the moving diaphragm or cone, and moves in and out of a constant magnetic field produced either by a permanent magnet (p-m dynamic loudspeaker) or by an electromagnet or field coil (electrodynamic loudspeaker). Interaction between the fixed magnetic field and that of the moving coil (called the voice coil) produces the motion that reproduces the desired sound waves. Also called *moving-coil loudspeaker*.

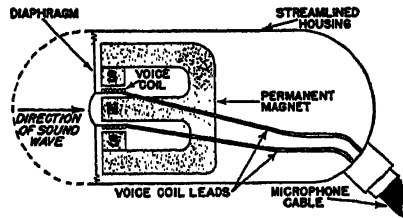

Cross-sectional view of a dynamic microphone.

dynamic microphone A microphone in which the flexible diaphragm is attached directly to a coil positioned in the fixed magnetic field of a permanent magnet. Sound waves move the diaphragm, causing motion of the attached voice coil with respect to the magnetic field, and thereby inducing the desired audio-frequency voltage in the coil. Sometimes called *moving-coil microphone*.

dynamic pickup A phonograph pickup in which the needle is attached directly, or through levers, to a coil or conductor positioned in the fixed magnetic field of a permanent magnet. The electrical output is due to motion of the coil in the magnetic field.

dynamic plate resistance The opposition that the plate circuit of a vacuum tube offers to a small increment of plate voltage. It is the ratio of a small change in plate voltage to the resulting change in plate current, other

DYNAMIC SENSITIVITY

tube voltages remaining constant. Dynamic plate resistance is usually designated by R_p , and is expressed in ohms. Often called *alternating-current plate resistance*.

dynamic sensitivity In a phototube, the alternating component of anode current divided by the alternating component of incident radiant flux. Radiant flux here means ultraviolet and infrared as well as luminous flux. The luminous sensitivity rating applies to visible light only. This rating expresses variational sensitivity; total sensitivity is expressed by the static sensitivity rating.

dynamo A machine for converting mechanical energy into electrical energy, generally called a generator. It may also be used as an electric motor by applying a suitable voltage to its terminals. The term dynamo more often applies to a direct-current generator, while alternator applies to an alternating-current generator.

dynamoelectric Pertaining to the conversion of mechanical energy into electrical energy, or vice versa.

dynamoelectric machine Any rotating device that converts mechanical energy into electrical energy, or vice versa, as a dynamo, alternator, or electric motor.

dynamometer-type instrument An instrument in which current, voltage, or power is measured by the force between a fixed coil and a moving coil.

dynamotor A combination electric motor and generator having two or more separate armature windings and a common set of field poles. One armature winding receives direct current as a motor and produces rotation, and the others generate current as a dynamo or generator. Used to

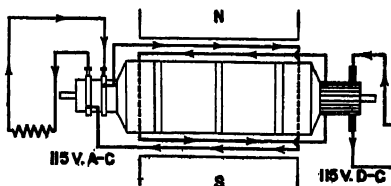

Dynamotor circuit.

change a direct voltage to an alternating voltage or to a higher direct voltage, chiefly in connection with portable or mobile operation of radio transmitters and public-address amplifiers from storage batteries.

dynatron 1. A four-electrode vacuum tube so designed that secondary emission of electrons from the plate causes the plate current to decrease as plate voltage is increased, giving a negative resistance characteristic. Used in oscillator circuits.

2. A mesotron.

dynatron oscillation

Oscillation occurring in a vacuum-tube circuit due to secondary emission of electrons from the plate, giving a negative resistance characteristic.

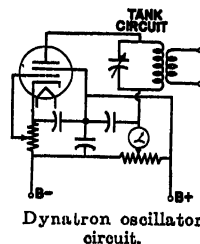

dynatron oscillator A vacuum-tube oscillator circuit utilizing the negative resistance characteristic of a dynatron tube.

dyne The unit of force in the centimeter-gram-second system. It is that force which will give an acceleration of one centimeter per second during each second to a free mass of one gram.

dyne per square centimeter The unit of sound pressure. One dyne per square centimeter was originally called a bar in acoustics, but the full expression is used today in this field because in all other fields a bar is 1,000,000 dynes per square centimeter.

dynetric balancing An electronic method of measuring and locating positions of off-balance components of all types of rotating parts, ranging from aircraft instrument gyros weighing a few ounces to massive marine gears weighing tons.

dynode One of the reflecting electrodes or electron mirrors in a multiplier-type phototube. It is coated with a material capable of high secondary emission, so that more electrons are emitted than are arriving at the electrode.

E

E Symbol for voltage. Usually used to represent a direct voltage or the effective (root-mean-square) value of an alternating voltage.

e Symbol for voltage. Usually used to represent the instantaneous value of an alternating voltage.

E_g Symbol for the grid bias voltage applied between the control grid and the cathode of a vacuum tube.

E_p Symbol for the direct-current plate voltage applied between the plate and cathode of a vacuum tube.

E_{sg} Symbol for the direct-current screen grid voltage applied between the screen grid and the cathode of a vacuum tube.

earth The ground, which acts as a large conductor and a return path for both radio and electrical systems. The term earth is used in Great Britain, while ground is used in the United States.

earth currents 1. Currents flowing through the ground due to natural causes, affecting the magnetic field of the earth and sometimes causing magnetic storms. 2. Return, fault, leakage, or stray currents passing through the earth from electrical equipment.

earthed Connected to earth or to some conducting body that serves in place of the earth. A British term, corresponding to grounded.

earth inductor A coil arranged to permit rotation in the earth's magnetic field. The resulting induced current is a measure of the intensity of the magnetic field of the earth.

earth inductor compass A compass whose indications depend on the current generated in a coil revolving in the magnetic field of the earth. Also known as *induction compass*.

eccentric circle A blank endless groove provided at the inside of some phonograph records to actuate the tripping mechanism of an automatic record changer after the record has been played. The center of the groove differs from the center of the record, so that the needle and pickup arm move back and forth once the needle enters this groove.

eccentric spiral The blank spiral groove leading from the end of a phonograph record to the eccentric circle.

Eccles-Jordan circuit A direct-coupled multivibrator circuit with two conditions of stable equilibrium. Also known as *flip-flop circuit*.

echo 1. A sound wave heard after reflection from one or more surfaces. 2. A radio wave that has been reflected one or more times, so that it is received separately from the main transmission a short interval of time later. 3. In general, a wave that has been reflected from one or more impedance irregularities or otherwise returned with sufficient magnitude and delay to be perceived in some manner as a wave distinct from that directly transmitted.

echo area The effective scattering cross-section area of a radar target.

echo chamber A reverberant room or enclosure used in a radio studio to add hollow effects or actual echoes to radio programs. The same effect may also be produced electrically.

echo depth sounding A system of determining ocean depth by measuring the time interval between production of a sound just below the surface of the water and arrival of the echo reflected from the bottom of the ocean. In modern apparatus, either magnetostriction or piezoelectric units are used for transmitting and receiving

ECHO RANGING

the sounds, and electronic equipment is employed to provide a continuous indication of depth, sometimes with continuous recording.

echo ranging The determination of both direction and distance of an underwater object from a vessel.

eco Abbreviation for electron-coupled oscillator.

eddy currents Circulating currents induced in a conducting material by a varying magnetic field. These currents are undesirable in most instances because they represent loss of energy and cause heat. In the iron cores of transformers and other iron-core devices carrying alternating current, laminated construction is used to shorten the paths for eddy currents and thus keep eddy-current losses at a minimum.

Edison base The standard screw-thread base used for ordinary electric lamps. The threaded portion serves as one terminal, and a metal button at the bottom of the base forms the other terminal.

Edison effect The emission of electrons from hot bodies. The rate of emission increases rapidly with temperature. Discovered by Edison in 1883, when a current flow was obtained between the filament of an incandescent lamp and an auxiliary electrode placed in the bulb. Also known as *Richardson effect* or *thermionic emission*.

Edison storage cell A storage-type cell having negative plates of iron oxide and positive plates of nickel oxide immersed in an alkaline solution and producing an open-circuit voltage of 1.2 volts per cell. A 6-volt Edison storage battery has five cells.

effective antenna length The electrical length of an antenna. It is that length which, when multiplied by the current at the point of maximum current, will give the same product as the length and uniform current of an elementary dipole antenna at the same location and will give the same radio field intensity in the direction of maximum radiation.

effective bandwidth For a band-pass filter, the width of a hypothetical "rectangular" band-pass filter that would pass the same mean-square value of noise, current, or voltage, with the same transfer ratio at a reference frequency (usually mid-band).

effective current That value of alternating current which will give the same heating effect as the corresponding value of direct current. The effective value is 0.707 times the peak value in the case of sine-wave alternating currents.

effective field intensity The root-mean-square value of the inverse distance fields at a distance of 1 mile from the transmitting antenna in all directions in the horizontal plane.

effective height 1. An antenna rating used chiefly with grounded vertical broadcast antennas. The effective height is the true electrical height, corresponding to a perfect antenna that will produce the same field strength. 2. The virtual height of an ionized layer of the ionosphere.

effective percentage modulation The ratio, for a single sinusoidal input component, of the peak value of the fundamental component of the envelope to the direct-current component in the modulated condition, expressed as a percentage.

effective resistance The total resistance of a device in an alternating-current circuit, equal to the ordinary direct-current resistance plus the equivalent resistance values due to skin effects occurring at high frequencies, hysteresis and eddy-current effects occurring in iron cores, and any other losses that occur.

effective signal radiated The basis for licensing radio transmitters, equal to the product of the square root of the effective radiated power times the antenna height in feet above the ground level.

effective sound pressure The root-mean-square value of the instantaneous sound pressure at a point over a

ELECTRICAL BANDSPREAD

complete cycle. The unit is the dyne per square centimeter. Frequently shortened to *sound pressure*.

effective value The alternating-current value that will produce the same amount of heat in a resistance as the corresponding direct-current value. All alternating-current meters, unless otherwise marked, indicate effective values of voltage or current. The effective value is also called the rms (root-mean-square) value because it is equal to the square root of the average (mean) of the squared instantaneous values equally spaced in an alternation or half-cycle. An alternating current of 5 amperes (assumed to be the effective value) will produce the same heat as a direct current of 5 amperes.

efficiency 1. The ratio of useful output energy to input energy, usually expressed as a percentage. A perfect electrical device would have an efficiency of 100 per cent. 2. For an electroacoustic transducer, the ratio of the useful power output to the signal power input.

efficiency of rectification The ratio of the direct-current power output to the alternating-current power input of a rectifier.

effluve A discharge similar to a corona discharge. Used in electrotherapy to stimulate the skin.

eight ball A nondirectional microphone having the shape of a ball.

Einstein coefficients Quantities that represent the probabilities of the emission or absorption of radiation quanta by an atom within a unit of time.

Einstein photoelectric equation An expression stating that the kinetic energy of an escaped photoelectron is equal to the energy quantum of the incident radiation minus the photoelectric work function for the metal concerned.

Einthoven galvanometer A galvanometer in which current to be measured is sent through a wire located in

a strong magnetic field. The displacement of the wire is a measure of the current. Also called *string galvanometer*.

elastance A measure of the difficulty with which an electric displacement can be produced in a capacitor. It is measured in darafs, and is the reciprocal of capacitance.

elasticity The ability of a material to return to its original shape after being stretched, bent, or otherwise deformed.

E layer An ionized layer in the E region of the ionosphere.

Electralloy A soft-iron alloy used in sheet form as chassis units or panels for electronic equipment.

electric Containing, producing, arising, from, actuated by, or carrying electricity, or designed to carry electricity and capable of doing so. Examples are electric motor, electric wave, electric lamp, etc. There are, however, many cases where usage determines the selection between electric and electrical or where these two terms are used interchangeably.

electrical Related to, pertaining to, or associated with electricity, but not having its properties or characteristics. Examples are electrical engineer, electrical rating, electrical handbook. Often used interchangeably with electric.

electrical angle A means of specifying a particular instant in an alternating-current cycle. One cycle is considered equal to 360 degrees, hence a half cycle is 180 degrees and a quarter cycle is 90 degrees. If one voltage reaches a peak value a quarter of a cycle after another, the electrical angle between the voltages (the phase difference) is 90 degrees.

electrical bandspread The use of a small variable capacitor in parallel with each tuning capacitor section in a short-wave receiver to spread the stations in a single band over the entire range of a dial and thereby obtain more accurate tuning.

ELECTRICAL CENTER

electrical center That point approximately midway between the ends of an inductor or resistor which divides the inductor or resistor into two equal electrical values, as voltage, resistance, inductance, or number of turns. A properly positioned center tap would be at the electrical center.

electrical control The control of a machine, device, or action by switches, relays, rheostats, or other equipment not employing electron tubes.

electrical degree 1. The 360th part of the angle subtended, at the center of the armature shaft of a rotating machine, by two consecutive field poles of like polarity. 2. One 360th of a cycle of an alternating current or an alternating voltage.

electrical engineer An engineer whose training or occupation is in electrical engineering, dealing with the generation, transmission, and utilization of electrical energy.

electrical inertia Inductance, which opposes any change in current flow through an inductor (coil).

electrical length That value of an antenna length in free space (not affected by the earth or near-by objects) which will give the same radiation characteristics as a given antenna in a normal location near the ground. The electrical length is about 5 per cent less than the actual physical length, because of capacitance effects (end effects) at the ends of the antenna wire.

electrical modulation In facsimile, the method by which the carrier is introduced into an electrical modulator along with the signal currents directly produced by density changes of the subject copy.

electrical precipitation The removal of particles in the air or in gases by charging the particles with electricity, then attracting them to charged electrodes.

electrical transcription A 16-inch diameter recording made especially for broadcast purposes. It is designed

for playing at a speed of $33\frac{1}{3}$ revolutions per minute, and has exceptionally high fidelity. Transcriptions permit broadcasting of the same message or program by any number of stations at any desired time.

electrical twinning A defect occurring in natural quartz crystals, in which adjacent regions of quartz have their electrical axes oppositely poled. Each type of axis is usable but not both in the same plate. During manufacture, the dividing line is marked on the crystal and the regions subsequently separated.

electric axis An X axis in a quartz crystal. There are three in each crystal, each parallel to one pair of opposite sides of the hexagon. All pass through and are perpendicular to the Z, or optical, axis.

electric bell A signaling apparatus in which a hammer is actuated electromagnetically so as to strike a gong or bell.

electric brazing Any brazing process in which the heat is obtained from an electric current. Thus, induction brazing is an electric-brazing process in which the heat is obtained from induced current.

electric breakdown An electric discharge taking place through an insulating material.

electric chair A chair equipped with suitable electrodes for executing the death penalty by electrocution.

electric charge Electric energy stored on the surface of an insulated object. It is positive when there are fewer electrons than normal, and negative when there are more electrons than normal.

electric chronograph An apparatus for measuring and recording intervals of time with a high degree of accuracy. By closing contacts, current impulses are sent through electromagnets that act on a recording pen to produce indications on a paper strip traveling at a known speed.

ELECTRIC-FILAMENT LAMP

electric circuit A path or group of interconnected paths capable of carrying electric currents.

electric clock A clock consisting of a small alternating-current motor that drives the time-indicating hands through a train of reduction gears. The motor runs at a speed determined by the frequency of the alternating current, which in turn is accurately controlled at the power-generating station.

electric controller A device or group of devices that governs in some predetermined manner the electric power delivered to the apparatus served by the controller.

electric current The time rate at which electrons pass a point in a circuit.

electric depilation Removal of hair by electrolytic methods.

electric depth finder Any electrically operated device that determines the exact lapse of time between the emission of oscillator signals, radio waves, or other mechanically or electrically produced sound waves downward from ships at sea or from aircraft in flight, and the return of the echo after reflection from the ocean bottom or the land surface. With the time lapse and the speed of travel known, the depth of water or the actual height above land may be calculated. Usually calculation is unnecessary as most depth finders are calibrated to read directly in feet or fathoms.

electric detonator A cap filled with an explosive mixture in which is imbedded a fine resistance wire connected to external terminals. When a current is sent through the wire, it heats and detonates the mixture.

electric dipole A simple antenna comprising a pair of conductors that is capable of radiating an electromagnetic wave in response to a displacement of electric charge from one conductor to the other. For theoretical purposes, the elementary dipole is so small that its directive properties are independent of its size and shape.

electric discharge lamp An artificial source of light in which light is produced by the passage of electricity through a metallic vapor or a gas enclosed in a tube or bulb.

electric displacement 1. Electric flux density or electric induction. 2. The electric displacement at any point in an isotropic dielectric is a vector that has the same direction as the electric intensity and has a magnitude in electrostatic units that is proportional to the electric intensity of the point.

electric doublet A system that has an electric moment and is mathematically equivalent to a system consisting of two infinite charges of opposite sign at an infinitesimal distance apart.

electric eel An eel-shaped fish (*Electrophorus electricus*) of South America, growing to a length of 6 feet and having electric organs in its tail muscles which are capable of disabling large animals by electric shock.

electric eye 1. Popular name for a photoelectric cell of any type. 2. Popular name for the cathode-ray tuning-indicator tube used in some radio receivers. It consists of a fluorescent screen having a dark sector that varies in size in direct proportion to the strength of the incoming signal. The receiver is accurately tuned when the width of the dark sector is a minimum.

electric field A region in space surrounding a charged object, or the electric component of the electromagnetic field associated with radio waves and with electrons in motion. Lines drawn to represent the direction in which the electric field will act on other charged objects are called electric lines of force. An electric field is a vector field in which the vector is the electric intensity.

electric field strength See *electric intensity*.

electric-filament lamp A light source consisting of a glass bulb containing a filament electrically maintained at incandescence.

ELECTRIC FILTER

electric filter An arrangement of electronic parts such as resistors, inductors, capacitors, and quartz crystals, which suppresses certain frequencies in a complex electrical signal.

electric flux 1. Electric lines of force. 2. The electric flux through a surface is the integral over the surface of the normal (perpendicular) component of the electric intensity.

electric furnace A furnace in which an electric current is the source of heat. Examples are the arc furnace, resistance furnace, and induction furnace.

electric generator A machine that transforms mechanical power into electric power.

electric gun A name sometimes given to an electromagnet having a projecting iron core, arranged so that an aluminum ring placed around the core is projected into space when the magnet is energized with alternating current.

electric hysteresis Internal friction occurring in a dielectric material like paper or mica when subjected to a varying electric field, as in a capacitor in an alternating-current circuit. It is accompanied by generation of heat in the dielectric, and this can eventually cause breakdown of the capacitor.

electrician A person engaged in the practice of electricity, particularly as it applies to electric motors, electric appliances, industrial and home electric wiring, and associated practical functions.

electric image An electrical counterpart of an object, comprising a fictitious distribution of electricity that is mathematically equivalent to the actual distribution on a near-by real object. An image antenna is an example.

electric induction 1. The process of charging an object electrically by bringing it into the electric field of a charged object. Also called *electrostatic induction*. 2. The electric induction at any point in an isotropic dielectric is a vector having the same direction as the electric intensity and

having a magnitude equal in electrostatic units to the product of electric intensity by the dielectric constant.

electric intensity The electric intensity at a point is a vector having the direction of the force that would be exerted on a charged particle placed at the point, and a magnitude equal to the quotient of the force divided by the quantity of electricity on the particle. Also called *electric field strength*.

electricity A fundamental quantity in nature, consisting of electrons and protons at rest or in motion. Electricity at rest has an electric field that possesses potential energy and can exert force, as in charged pith balls. Electricity in motion has both electric and magnetic fields that possess potential energy and can exert force, as in an electric motor. Electricity in motion ordinarily consists of a movement of electrons through a conductor or through space.

electricity meter A device that measures and registers the integral of an electric quantity with respect to time. Also called meter, but this term should be used only when the usage is such as to prevent confusion with other meanings of meter. Examples of electricity meters are watt-hour meter, ampere-hour meter, coulometer, and var-hour meter.

electric lamp A lamp in which the light is produced by electricity, as in the incandescent lamp, arc lamp, glow lamp, mercury-vapor lamp, and fluorescent lamp.

electric light Light produced by an electric lamp. This light may be produced by using an electric current to heat a resistance material to incandescence, to ionize a gas and produce a luminous glow discharge, or to ionize a gas and thereby activate a fluorescent material.

electric moment The electric moment of two charges having equal magnitude and opposite sign is a vector whose magnitude is equal to the product of the magnitude of each charge by the distance between the centers of the charges. The direction of the vector

ELECTRIC TRANSDUCER

is from the negative to the positive charge.

electric motor A machine for transforming electrical energy into mechanical energy.

electric network A combination of any number of electric elements, the impedances of which may be either lumped or distributed, or both. The elements may be connected in any manner. It is assumed to be a passive electric network (containing no source of energy) unless otherwise stated. An active electric network contains one or more sources of energy.

electric organ A musical instrument using electronic tubes and circuits to produce music similar to that of a pipe organ.

electric oscillations Oscillations are set up whenever a circuit containing inductance and capacitance is electrically disturbed. The oscillations are charges of electricity flowing alternately in opposite directions through the circuit.

electric phonograph An electromechanical transducer actuated by power in a mechanical system (in the rotating phonograph record) and supplying power to an electrical system (amplifier and loudspeaker), with the reproduced sounds having frequency components corresponding to those in the record.

electric phonograph recorder An electromechanical transducer actuated by power in an electric system and supplying power to a recording mechanical system. The recorder waves produced by the mechanical system have a wave form corresponding to that in the electric system.

electric potential The degree of electrification as referred to some standard having zero potential, such as the earth. The potential at a point is the amount of work required to bring a unit quantity of electricity from infinity to that point. Potential and voltage are used interchangeably.

electric potential difference 1. The algebraic difference between the indi-

vidual potentials of two points; the voltage existing between two points. 2. The amount of work required to bring a unit charge from one point to the other. Equivalent phrases more commonly used are *potential difference*, *voltage*, and *voltage drop*.

electric precipitation The collecting of dust or other finely divided particles of matter by charging the particles inductively with an electric field, then attracting them to highly charged collector plates. One commercial version is called the *Precipitron*.

electric shock therapy The use of an electric current to induce convulsions in the treatment of certain types of insanity. Also called *electromarcosis* or *shock therapy*.

electric sleep Anesthesia produced by means of Leduc currents (interrupted direct current).

electric steel Steel that has been refined in an electric furnace.

electric strain gage A strain gage in which the change in the shape of the structural member under load causes a corresponding variation in the current flowing through the gage.

electric strength The maximum potential gradient that a dielectric material can withstand without rupture. Also called *dielectric strength* and *insulating strength*.

electric telemeter The complete measuring, transmitting, and receiving apparatus for indicating, recording, or integrating at a distance, by electric translating means, the value of a quantity.

electric telemetering The indicating, recording, or integrating of a quantity at a distance by electric translating means such as voltage, current, frequency, or impulses.

electric transducer An electric network by means of which energy may flow from one or more transmission systems to one or more other transmission systems. The simplest example is a

ELECTRIC VECTOR

transformer having two input terminals and two output terminals.

electric vector That component of the electromagnetic field associated with electromagnetic radiation which is of the nature of an electric field. The electric vector is supposed to coexist with, but act at right angles to, the magnetic vector. Related terms are *Poynting's vector* and *Hertzian vector*.

electric wave Another name for a radio wave or Hertzian wave produced by oscillations of electricity in a conductor.

electric-wave filter A selective network that transmits freely electric waves having frequencies within one or more frequency bands, and which substantially attenuates electric waves having other frequencies.

electric wind A current of air or other gas repelled from a highly electrified pointed conductor. The wind can also be due to streams of ions moving in the electric field.

electrification 1. The process of establishing an excess of positive electricity or negative electricity in a body. 2. The conversion of a system, such as a railroad, to operation from electric sources of power.

electroacoustic transducer A transducer (energy-transferring device) by which power may flow from an electric system to an acoustic system, or vice versa. Loudspeakers and microphones are examples.

electroanalysis The process of depositing an element or compound upon an electrode by electrolysis for the purpose of determining its quantity in the solution used as electrolyte.

electroarteriograph An instrument for testing blood flow. One type uses a phototube to measure color changes after a dye is injected into the blood stream. Also called *plethysmograph*.

electroballistics Measurement of the speed of projectiles by electrical or electronic methods.

electrobiology The science dealing with electric phenomena of living creatures.

electrobioscopy Application of a voltage to an animal body to detect signs of life by the production of muscular contractions.

electro-capacitance altimeter An altimeter whose indications depend on the variation of an electric capacitance with distance from the surface of the earth.

electrocapillarity The change in surface tension between two liquids in contact, due to potential gradient.

electrocardiogram A photographic or other graphic trace of the manner in which the electric current or voltage associated with the action of heart muscles varies with time. This record is obtained with an electrocardiograph.

electrocardiograph An instrument for recording the changes in voltage occurring in the human body in synchronism with heartbeats.

electrocautery An apparatus for cauterizing tissue, consisting of a holder supporting a wire that may be heated to red or white heat by a current of electricity.

electrochemical equivalent The weight of an element, compound, radical, or ion involved in a specified electrochemical reaction during the passage of a specified quantity of electricity such as a faraday, ampere-hour, or coulomb.

electrochemical recording Facsimile recording by means of the chemical reaction occurring when a signal-controlled current is sent through the chemically treated record sheet of a facsimile receiver.

electrochemical valve An electric valve consisting of a metal in contact with a solution or compound, across the boundary of which current flows more readily in one direction than in the other direction, and in which the valve action is accompanied by chemical changes. The electrolytic rectifier is an example.

ELECTRODESICCATION

electrochemical-valve metal A metal or alloy having properties suitable for use in an electrochemical valve.

electrochemistry The science that deals with the relations between electricity and chemical changes. In electrolysis, electricity produces chemical changes. In batteries, chemical changes produce electricity.

electrocoagulation The coagulation of tissue by means of a high-frequency electric current. It involves hardening and devitalizing of tissues, especially tumors, by the generation of heat within the tissue to be destroyed.

electroculture The stimulation of growth, flowering, or seeding by electrical means.

electrocute To kill by an electric shock.

electrocution The destruction of life by means of electric current.

electrode 1. One of the essential parts inside a vacuum tube, such as the cathode, plate, and the various grids. 2. One of the plates of a primary cell or secondary cell. 3. One of the plates of an electrolytic capacitor. 4. One of the carbons of an arc lamp or an electric arc furnace. 5. One of the gap surfaces in a spark gap. 6. In general, a surface of contact between a metallic conductor or carbon and a nonmetallic conductor such as an electrolyte, an ionized gas, or a vacuum through which electrons are moving. 7. In metal arc welding, the wire or rod that serves as the filler metal and through which current is conducted between the electrode holder and the arc. 8. In carbon arc welding, the carbon or graphite rod through which current is conducted between the electrode holder and the arc.

electrode admittance The alternating component of electrode current divided by the alternating component of electrode voltage, all other electrode voltages being maintained constant.

electrode capacitance The capacitance between one electrode and all the other electrodes connected together.

electrode characteristic The relation between voltage and current values of an

electrode, other electrode voltages being maintained constant. Usually shown by a graph.

electrode conductance The in-phase component of the alternating current of an electrode divided by the alternating voltage of that same electrode, all other electrode voltages being maintained constant. This is a variational and not a total conductance.

electrode current The electron flow through vacuum space to or away from an electrode in a vacuum tube.

electrode dissipation Power dissipated as heat in a vacuum-tube electrode as a result of electron bombardment or ion bombardment.

electrode impedance The reciprocal of electrode admittance.

electrodeless discharge A luminous discharge in a gas-filled glass tube having no internal electrodes, due either to a high-frequency electric field acting on the gas by capacitor action through the glass walls, or due to the inductive action of current flowing in a neighboring high-frequency circuit. As an example, a fluorescent tube will glow when placed alongside an energized radio transmitting antenna.

electrodeposition The process of depositing a substance on an electrode by electrolysis, as in electroplating, electroforming, electrorefining, or electro-winning.

electrode potential 1. The difference in potential existing between an electrode and the solution or electrolyte in which it is immersed. 2. The instantaneous potential or voltage of an electrode with respect to the cathode of a vacuum tube.

electrode resistance The reciprocal of the electrode conductance.

electrodermal reaction The change in the electrical resistance of the skin with the emotional condition of a person. The resistance decreases appreciably when a person is not telling the truth.

electrodesiccation The destruction of animal tissue by high-frequency electric sparks from an electrode.

ELECTRODESICCATOR

electrodesiccator An instrument that produces sparks between an electrode and the skin for the purpose of removing malignant growths in spark therapy.

electrode voltage The voltage between an electrode and the cathode.

electrodiagnosis Determination of the functional condition of various organs and tissues by studying their response to electric stimulation.

electrodissolution The process of dissolving a substance from an electrode by electrolysis.

electrodynamic instrument A meter that measures current strength by utilizing the forces of attraction and repulsion existing when current is sent through sets of fixed and movable coils. Used chiefly for measuring alternating current. Also called *electrodynamometer*.

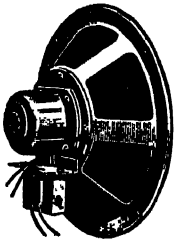

Electrodynamic loudspeaker.

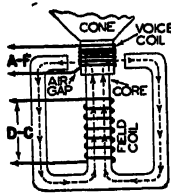

electrodynamic loudspeaker A dynamic loudspeaker in which the fixed magnetic field is produced by an electromagnet called the field coil, to which a direct current must be furnished.

electrodynamics The science dealing with the various phenomena of electricity in motion, including interactions of currents with each other, with their associated magnetic fields, and with other magnetic fields.

electrodynamometer An electrodynamic instrument.

electroencephalograph An instrument for recording the wave forms of voltages developed in the brain.

electroextraction The extraction of metals or compounds from ores and intermediate compounds by electrochemical processes.

electroforming The production or reproduction of certain articles by electrodeposition, as in electrotyping.

electrographic A term applied to the action of cathode rays on a metal surface. The metal exposed to cathode rays becomes less subject to the action of corrosive vapors, making it possible to develop cathode-ray images.

electrokinetics The branch of science that deals with the laws of electricity in motion.

electrokymograph An electric apparatus that traces curves of variations in pressure or other varying quantities on recording paper drawn through the machine by an electric motor. Used in the study of respiratory, diadochokinetic, and other movements during physiological investigations.

electrolysis The production of chemical changes by the passage of current through an electrolyte. The action is often undesirable in that it causes corrosion of metal objects.

electrolyte The liquid, chemical paste, or other conducting medium used between the electrodes of a dry cell, storage cell, electrolytic rectifier, electrolytic capacitor, electroplating cell, etc., in which the current flow consists entirely of charges carried by ions or colloidal particles.

electrolytic Pertaining to or deposited by electrolysis.

electrolytic capacitor A capacitor consisting of a combination of two con-

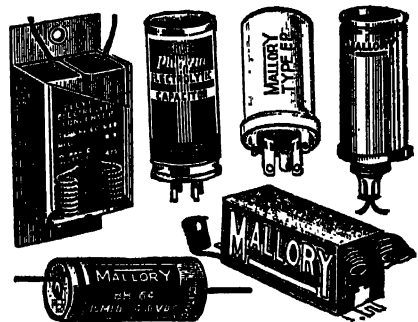

Electrolytic capacitors.

ductors, at least one of which is a valve metal, separated by an electrolyte. A dielectric film, usually a thin layer of gas, is formed between the conductors, adjacent to the surface of one or both.

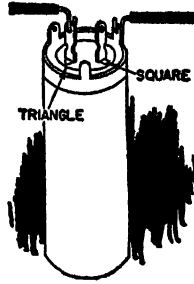

Electrolytic capacitor in metal can. Square and triangular cut-outs in insulating wafer identify the terminal lugs.

electrolytic cell A unit apparatus designed for carrying out an electrochemical reaction.

It includes a vessel, two or more electrodes, and one or more electrolytes.

electrolytic condenser An electrolytic capacitor.

electrolytic conduction Current flow due to movement of ions in an electrolyte when a voltage is applied between electrodes immersed in an electrolyte.

electrolytic copper Copper obtained from ore by an electrolytic process.

electrolytic deposition Electroplating.

electrolytic dissociation The process by which some fraction of the molecules in an electrolytic solution are decomposed to form ions.

electrolytic interrupter A device for regularly interrupting an electric current, consisting essentially of two electrodes immersed in a dilute acid solution.

electrolytic iron A pure iron obtained by an electrolytic process. It has excellent magnetic properties, and hence is often used for iron cores of coils.

electrolytic oxidation An electrolytic process by which electrons are removed from, or positive charges are added to, an atom or ion. It occurs only at an anode.

electrolytic pickling The removal of oxides or other compounds from a metal surface by passing a current through the metal and the acid pickling solution in which it is immersed.

electrolytic recording In facsimile, a form of electrochemical recording in which the chemical change is made possible principally by ionization.

electrolytic rectifier A rectifier consisting of metal electrodes which, when immersed in a suitable electrolyte, permit the passage of current much more readily in one direction than the other.

electrolytic reduction An electrolytic process by which electrons are added to, or positive charges are removed from, an atom or ion. It occurs only at a cathode.

electrolytic refining The refining or purifying of metals by electrolytic processes.

electrolyzer 1. An electrolytic cell for the production of alkali, chlorine, or other allied products. 2. A device used in electrotherapy for reducing urethral stricture with the aid of electricity.

electromagnet A core of soft iron that is strongly magnetized by sending current through a coil of wire wound around the core. Electromagnets are used for lifting heavy masses of iron by magnetic attraction, and for attracting movable iron objects in electric devices such as relays.

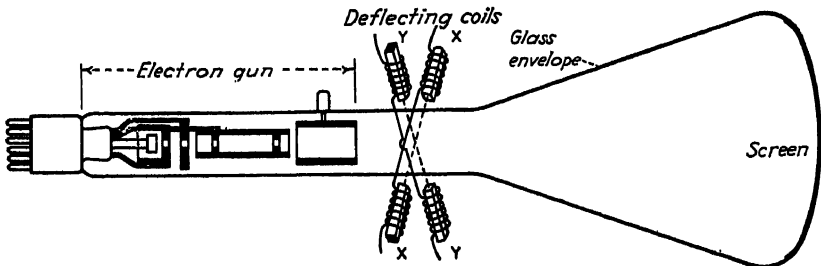

Electromagnetic deflection type of cathode-ray tube.

ELECTROMAGNETIC

electromagnetic Pertaining to an electromagnet or to the combined electric and magnetic fields associated with movements of electrons through conductors.

electromagnetic crack detector An instrument for detecting the presence of cracks in iron or steel objects. In one form, a strong magnetic field is passed through the object to be tested, and a liquid containing finely divided magnetic particles is applied to the surface. The particles adhere at points where external polarity is produced by the increased reluctance of the crack, thereby outlining cracks even though they are invisible.

electromagnetic field A rapidly moving electric field and its associated moving magnetic field located at right angles both to the electric lines of force and to their direction of motion.

electromagnetic horn A horn-shaped structure used for highly directive radiation of radio waves at frequencies of the order of 100 megacycles or higher. Power is fed to an exciting dipole or loop at the input end of the horn.

electromagnetic induction The production of a voltage in a coil due to a change in the number of magnetic lines of force (flux linkages) passing through the coil.

electromagnetic lens An electron lens in which focusing is produced electromagnetically.

electromagnetic mirror Any surface or region capable of reflecting radio waves, such as one of the ionized layers in the upper atmosphere.

electromagnetic percussive welding A welding process in which energy stored in a magnetic field is suddenly discharged through the work upon collapse of the field.

electromagnetic strain gage A strain gage in which the current variation is obtained by causing the strain of the structural member to move an armature in an iron-core coil, thereby changing the inductance of the gage.

electromagnetic theory of light The recognition of the identical nature of electromagnetic waves and light. It was established theoretically by James Clerk Maxwell before electromagnetic waves had been observed experimentally.

electromagnetic unit Any electric unit based primarily on the magnetic effect of electric current. The fundamental centimeter-gram-second unit in this system is the abampere.

electromagnetic wave The wave associated with an electromagnetic field traveling through space or through material media. It consists of electric and magnetic fields at right angles to each other. Electromagnetic waves are known as radio waves, heat rays, light, X rays, etc., depending on their frequency.

electromechanical Pertaining to a combination of electrical and mechanical forces or devices.

electromechanical recording Facsimile recording by means of a mechanical device, such as a stylus, which is actuated by the signal.

electrometallurgy That branch of science and technology which applies electric energy (by means of electrochemistry or electrothermics) to the extraction or treatment of metals.

electrometer An instrument for detecting or measuring voltage by means of the electrostatic forces exerted between bodies charged with the voltage. An electrometer may be a calibrated electroscopes or a special vacuum tube designed to amplify very small voltages.

electromotive force That property of a device which tends to produce an electric current in a circuit.

electromotive series An arrangement of the metal elements in the order of the amount of electromotive force (voltage) set up between metal and solution when the metal is placed in a normal solution of any of its salts. Each metal is negative to those preceding it

ELECTRON GUN

in the list, and positive to those succeeding it. The series for the more common metals is: potassium, sodium, barium, strontium, calcium, magnesium, aluminum, manganese, zinc, chromium, cadmium, iron, cobalt, nickel, tin, lead, copper, antimony, bismuth, mercury, silver, platinum, gold.

electromyograph An instrument for recording muscular action currents or physical movements during muscular contractions.

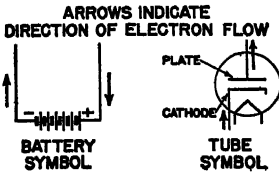

Electron flow in battery and tube.

electron The most elementary charge of negative electricity, equal to 4.774×10^{-10} electrostatic unit. The electron is the electrical opposite of the proton, but its mass is only approximately $1/1,847$ the mass of the proton. Electrons and protons are in all atoms. Electrons constitute cathode rays and beta rays, and are emitted by hot bodies. An electric current consists of movements of electrons. The word electron is believed to have been first used in an article by George J. Stoney in the July, 1891, issue of *The Scientific Transactions of the Royal Dublin Society*. Electron is a noun but is often used as an adjective, as in electron tube, electron gun, electron microscope, electron emission.

electronic The use of an electric current to induce convulsions in the treatment of certain types of insanity.

Also called *electric shock therapy* or *shock therapy*.

electron-beam generator A velocity-modulation generator, such as a klystron tube, used to generate extremely high frequencies.

electron-coupled oscillator An oscillator circuit employing a screen-grid tube so connected that its screen grid is used as a plate in connection with the control grid and cathode, in an ordinary triode oscillator circuit, and the output is taken from the plate circuit. The screen is at ground potential for radio-frequency voltage, and hence serves as a shield.

electron coupling A method of coupling two circuits inside a vacuum tube, used principally with multigrid tubes. The electron stream between electrodes in one circuit transfers energy to electrodes in the other circuit.

electron drift The actual movement of electrons in a definite direction through a conductor during current flow, as contrasted with transfer of energy from one electron to another by collision.

electron emission The ejection of electrons from the surface of a material into surrounding space under the influence of heat, light, high voltage, or any other cause. In a thermionic vacuum tube, electron emission from the cathode is produced by heat. Quantitatively, electron emission is the rate at which electrons are emitted from an electrode.

electron gun The structure in the neck of a cathode-ray tube, consisting of an electron-emitting cathode and associated electrodes that concentrate, con-

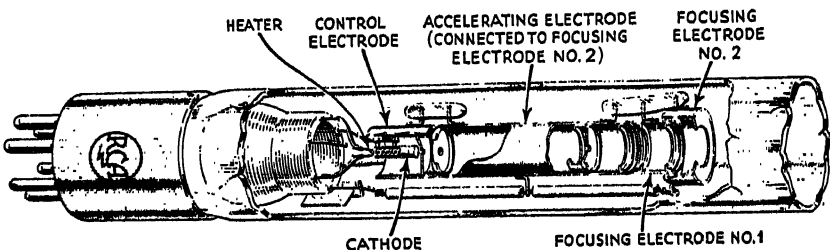

Electron gun for a cathode-ray tube.

ELECTRONIC

trol, and focus the stream of emitted electrons into a beam that produces a spot of the desired size on the screen at the end of the tube.

electronic Of or pertaining to an electron, electrons, or the general field of electronics. Electronic is an adjective, and is correctly used in phrases like the following: electronic research, electronic engineering, electronic equipment, electronic regulator, and similar phrases covering more than a single electron tube or device.

electronic autopilot An arrangement of gyroscopes combined with electronic amplifiers and servo motors to detect deviations in the flight of aircraft and apply the required corrections directly to the control cables of the aircraft. In the type C-1 electronic automatic pilot used in the B-29 Superfortress and other Allied bombers, three separate control channels are provided: for the rudder, the ailerons, and the elevators.

electronic chimes A set of tubular chimes actuated in a conventional manner by strikers electromagnetically controlled from a keyboard, with the resulting sounds being picked up by one or more microphones and amplified many times for reproduction by loudspeakers that are often located in the belfry of a church.

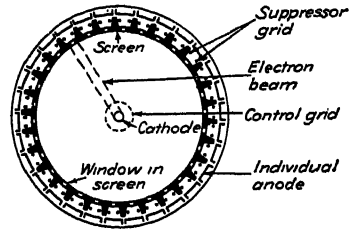

A 30-anode radial-beam tube with single rotating electron beam used as an electronic commutator in a 30-channel multiple telegraph system.

electronic commutator Any electron-tube device for switching one circuit connection rapidly and in succession to many other circuits. An example is the radial-beam tube, in which a rotating magnetic field causes an electron beam to sweep over one anode after another and produce the desired switching action.

electronic computing gunsight An electrical computing device used in connection with an electronic servo system on an aircraft gunsight to provide automatically the required offset between the line of sight and the gun, so as to compensate for such factors as gun elevation and direction, target range, bomber air speed, bomber altitude, relative velocity between bomber and target, and correction for windage and gravity. An example is the U. S. Army Model K-8 gunsight.

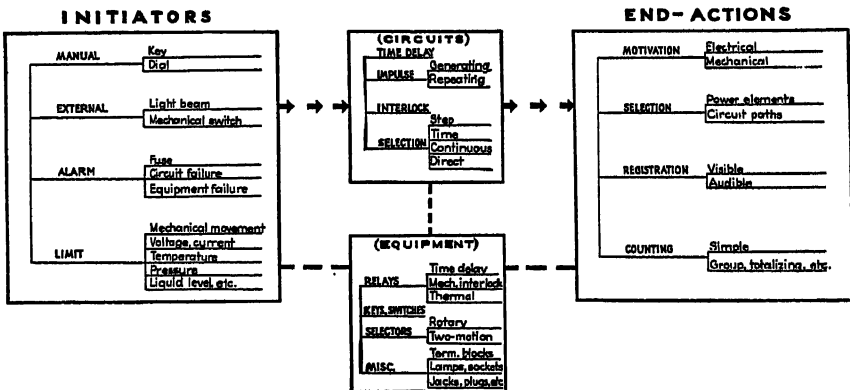

In electronic control, an initiating device detects a change and converts it into a suitable electrical impulse or current that makes appropriate circuits or equipment produce the desired end action. An example, an oversize object on a conveyor belt may interrupt a light beam and cause a phototube (the initiator) to send an impulse to an impulse-repeating circuit or amplifier which in turn feeds an electromagnetic solenoid that pushes the object off the conveyor.

electronic control The control of a machine, device, or action by equipment employing electron tubes, including vacuum tubes.

electronic curve tracer A photoelectric instrument in which a spot of light automatically traces along a curve. It can be used to integrate the area within the curve of a circular chart, to measure the area of any irregular object of closed curve, or to provide any desired type of summation of instantaneous values of a graph.

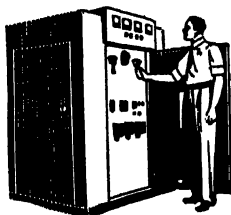

Electronic generator; actually an industrial version of a medium-power radio transmitter.

electronic generator A high-power oscillator used to generate radio-frequency energy for electronic heating.

electronic instrument An instrument that depends for its operation on the action of a thermionic tube that supplies current to a direct-current meter, as in a vacuum-tube voltmeter.

electronic photometer An electronic instrument designed to measure intensity of light, brightness of paints, turbidity of solutions, etc. It comprises a phototube, an electronic direct-current amplifier, and an indicating instrument.

electronic piano A piano without a sounding board, in which vibrations of each string affect the capacitance of a capacitor microphone and thereby produce audio-frequency signals that are amplified and reproduced by a loudspeaker.

electronic profilometer An electronic instrument for measuring surface roughness. The diamond-point stylus of a permanent-magnet dynamic pickup is moved over the surface to be examined, and the resulting varying voltage is amplified, rectified, and measured with a meter calibrated to

read directly in micro-inches of deviation from smoothness.

electronic rectifier A rectifier in which rectification of an alternating current is accompanied by the passage of electrons only at the boundary of an electrochemical valve metal and a compound of that metal, as in a copper-oxide rectifier or a selenium rectifier.

electronic scanning Scanning with a cathode-ray tube, as contrasted with mechanical scanning with a rotating disk or mirror drum.

electronic switch A circuit designed to cause a start-and-stop action or a switching action by electronic means.

electronic television A television system employing cathode-ray tubes to scan the scene at the transmitter and to reconstruct it at the receiver. The process is electrical, with no moving mechanical parts.

electronic voltmeter A voltage-measuring instrument utilizing the characteristics of a vacuum tube for measuring voltages with minimum effect on the circuit to which the instrument is connected.

electronics That branch of science which relates to the conduction of electricity through gases or in a vacuum. Electronics is thus a broad field of electricity including all types of applications for electron tubes in radio, television, facsimile, diathermy, industrial control, etc. Electronics is a noun, and is frequently used to modify another noun, as in electronics department, electronics laboratory, electronics committee.

electron image tube A cathode-ray tube having a cathode of large area, coated with light-sensitive material upon which an optical image is projected. This causes corresponding emission of electrons from each point on the cathode. The resulting emission is focused by electron lenses upon a fluorescent screen, producing there a visible image of whatever has been projected on the cathode. Used in an early form of electron microscope, in the electron telescope, and the infrared microscope.

ELECTRON LENS

electron lens An arrangement of electrodes with or without magnetic deflecting and focusing coils, used to control the direction and size of a beam of electrons in much the same manner that a glass lens controls a beam of light. The electrodes generally consist of metal plates with circular openings or cylindrical plates charged to a high positive potential with respect to the cathode of the electron gun that produces the electron beam.

electron microscope An instrument that sends a beam of electrons through a thin sample of the material being examined, magnifies the resulting shadow caused by denser portions of the sample, and makes this shadow visible on a fluorescent screen or records it on photographic film. Magnification as high as one hundred thousand times is possible. This is far higher than can be obtained with ordinary microscopes.

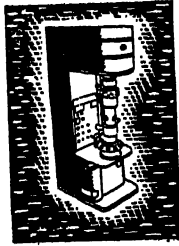

Electron microscope.

electron mirror One of the reflecting electrodes in a multiplier-type phototube. It is coated with a material having high secondary emission, so that more electrons are emitted than are arriving at the electrode. Also called *dynode*.

electron-multiplier phototube A vacuum-type phototube that employs secondary emission to amplify the electron stream emitted from the illuminated photocathode. The electron stream impinges in turn on each of a series of reflecting electrodes called dynodes, at each of which secondary emission adds electrons to the stream. In one tube, an amplification of approximately 2,000,000 times is obtained with nine dynodes. Also called *photoelectric electron-multiplier tube* and *multiplier phototube*.

electron-multiplier tube A vacuum tube in which the initial electron current emitted by a thermionic or light-sensitive cathode is reflected by a

number of anodes in sequence, with secondary emission from each anode adding to the electron stream. The final electron current arriving at the collector anode is the sum of the individual secondary emission currents and the initial cathode current. By multiplying the number of electrons in this manner, the tube provides a tremendous amount of amplification.

electronogen A molecule or group of moles which, according to the Kowalski theory of luminescence, emits electrons under the influence of light. The reverse action occurs in a lumenophor.

electron optics That branch of electronics which deals with the control of electron beams in a vacuum by means of electric or magnetic fields.

electron-ray tube A cathode-ray tuning indicator tube.

electron telescope An apparatus for seeing through haze and fog, in which an infrared image is formed by optical lenses on the cathode of an electron image tube, and then rendered visible by the tube.

electron transit time The time required for electrons to travel between two electrodes in a vacuum tube. This time is extremely important in tubes designed for ultrahigh frequencies.

electron tube A vacuum tube evacuated to such a degree that its electrical characteristics are essentially unaffected by gaseous ionization.

electron volt The amount of energy gained by an electron in passing from one point to another point that is one volt higher in potential. One electron volt is equal to 1.592×10^{-12} erg.

electroosmosis The movement of fluids through porous diaphragms, produced by the application of an electric potential.

electrophoresis A movement of colloidal particles, produced by the application of an electric potential.

electrophorus A device used to produce electric charges by induction, consisting of a metal plate and a disk of resin, shellac, ebonite, or similar

ELECTROSTATIC SEPARATOR

insulating material. In operation, the insulating disk is negatively electrified by friction, and the metal plate then placed on it and touched with the finger. The plate with its remaining positive charge is then removed by its insulating handle.

electroplane camera An optical-lens system in which one element is electronically oscillated back and forth to provide greater depth of field than can be obtained by optical means alone. Developed primarily for standard motion-picture cameras.

electroplate To place a coating of metal on a surface by means of electrolysis.

electroplating The electrodeposition of an adherent coating on an electrode, for the purpose of securing a surface with properties or dimensions different from those of the base metal. The metal to be plated is immersed in an electrolyte and connected to one terminal of a battery or other source of direct current, while the metal to be deposited is similarly suspended and connected to the other terminal of the voltage source. Metal is moved through the electrolyte from one electrode to the other by ions, the movement of which is due to current flow in the circuit.

electrorefining The process of dissolving a metal from an impure anode by means of electrodeposition and depositing it in a purer state.

electroscope Any of several types of instruments used for detecting small charges of electricity.

electrostatic Pertaining to electricity at rest, such as charges on an object (static electricity).

electrostatic charge
An electric charge stored in a capacitor or on the surface of an insulated object.



Electroscope.

electrostatic coupling Coupling by means of capacitance, so that charges on one circuit influence the other circuit through the capacitance.

electrostatic energy storage spot welder
A welder consisting essentially of a capacitor bank that is charged slowly to a predetermined voltage, then discharged suddenly through the material to be welded.

electrostatic field The region in space near an electrically charged object, sometimes called electric lines of force or an electric field.

electrostatic focusing Use of an electric field to focus an electron beam in a cathode-ray tube to the desired spot area at the surface of the fluorescent screen.

electrostatic generator A machine for generating electric charges, usually employing an endless belt of insulating material on which charges are produced by electric induction and discharged inside hollow terminals to produce high voltages. The Van de Graaff generator and Wimshurst machine are examples.

electrostatic induction The process of charging an object electrically by bringing it into the electric field of a charged object. Also called *electric induction*.

electrostatic instrument A meter that depends for its operation on the forces of attraction and/or repulsion between electrically charged bodies.

electrostatic percussive welding A percussive welding process in which a capacitor is used to supply the energy that is suddenly discharged.

electrostatic precipitator An electronic apparatus for removing small particles from air by electrostatic means, as in the Precipitron.

electrostatics That branch of science which deals with electricity at rest.

electrostatic separator An apparatus in which a finely pulverized mixture of the materials to be separated is allowed to fall in a stream through a

ELECTROSTATIC SHIELD

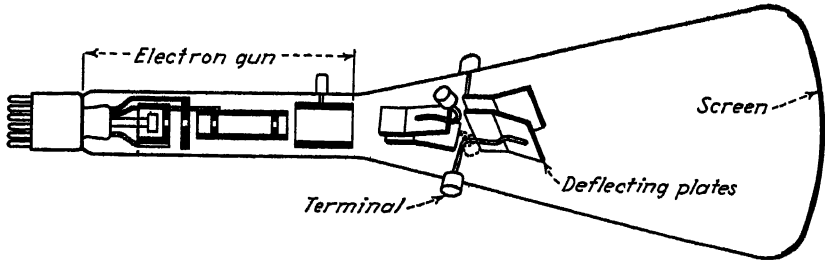

Electrostatic deflection type of cathode-ray tube.

powerful electrostatic field produced between two electrodes. Materials having different specific inductive capacitances are deflected by varying amounts and caused to fall in different piles.

electrostatic shield A grounded metal screen, sheet, or object placed around a radio device, as a loop antenna or a coil, or placed between two devices to prevent the action of any electric field through the shield. Often used to prevent interaction between the electric fields of adjacent parts on a chassis.

electrostatic unit An electric unit based primarily on the dynamic interaction of the electric charges. The fundamental centimeter-gram-second unit in this system is the electrostatic unit charge which, if concentrated upon a small sphere, would repel a similar charge one centimeter distant in a vacuum with a force of one dyne.

electrostatic voltmeter An instrument in which the voltage to be measured is applied between fixed and movable metal vanes. The resulting electrostatic force moves the movable vane against the tension of a spring, and an attached pointer indicates the voltage of the circuit.

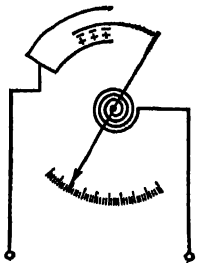

Basic construction of an electrostatic voltmeter for high-voltage measurements.

electrostriction The contraction or expansion of a quartz or other crystal along an electric axis when subjected

to an electric field in that direction. Also called *inverse piezoelectric effect*.

electrotherapist A medical specialist skilled in treating disease by means of electricity.

electrotherapy The art of treating disease by means of electricity.

electrothermal recording A type of electrochemical facsimile recording in which the chemical change in the record sheet is produced principally by heat that is controlled by the incoming signal.

electrothermic instrument A meter that depends for its operation on the heating effect of a current. Two distinct types are the thermocouple type and the expansion type which includes hot-wire instruments.

electrothermics That branch of science and technology which deals with the direct transformation of electric energy into heat.

electrotonus The change in the irritability of a nerve or muscle during the passage of an electric current.

electrotropism The tendency of certain plants to curve under the influence of an electric current.

electrotype A printing plate made by electrolytically depositing copper or nickel in a wax or soft lead impression of the desired printing surface and backing this shell with molten metal. The wax mold is made conductive for electroplating by coating it with graphite. Electrotypes are usually made to secure duplicates of more costly original engravings.

EMISSION CHARACTERISTIC

electrotyping The production or reproduction of printing plates by electroforming.

electrowinning The electrodeposition of metals or compounds from solutions derived from ores or other materials, using insoluble anodes.

electrum 1. A natural alloy of gold and silver. 2. A plating of German silver.

element 1. In chemistry, one of the known 92 substances that cannot be divided into simpler substances by any means ordinarily available. 2. Any unit part of a whole, such as an element of a lens or vacuum tube. 3. One of the antennas in an array.

elemental area The smallest segment scanned at any given instant in a television or facsimile system. It can be considered a square area having dimensions equal to the width of the scanning line.

elementary charge The natural unit or quantum into which both positive and negative charges appear to be subdivided. It is the charge on a single electron, and its value is about 4.77×10^{-10} electrostatic unit.

elevation The vertical distance above a reference level, usually sea level, to a point or object on the surface of the earth, as distinguished from altitude, which refers to points above the earth's surface.

elevation angle The angle that a radio wave makes with the horizontal.

eliminator A device that takes the place of batteries in a radio receiver. Usually called a B eliminator. It generally consists of a rectifier operating from alternating current.

elliptic polarization Polarization in which the end of the rotating vector representing the vibrations in a beam of polarized radiation traces an ellipse during each polarization cycle.

elliptically polarized wave A transverse wave in which the displacement vector at any point rotates about the point, and has a magnitude that varies as the radius vector of an ellipse.

elongation The extension or elongation of the envelope of a signal due to delayed arrival of certain of the multipath components.

emanation The gaseous radioactive products formed by the expulsion of an alpha particle from radium, thorium X, or actinium X. Now known as radon, thoron, and actinon, respectively.

embossed groove recording A method of recording vocal sounds on disks or film strips by embossing sound grooves with a relatively blunt stylus, rather than by cutting grooves with a sharp stylus. Embossing throws the material up in furrows on each side of the sound groove, without removing any material.

emergency communication With respect to ship stations, the transmission or reception of distress, alarm, urgent, or safety signals, or messages relating thereto or any matter relating to the safety of life or property, or occasional operation of equipment for determining whether or not the radio installation is in good working condition.

emergency receiver A receiver immediately available in a ship station for emergency communication and capable of being energized solely by the emergency power supply.

emergency service A radiocommunication service carried on for emergency purposes.

emergency switch A switch located ahead of meters in some buildings for the purpose of cutting off all electric power in case of a fire or other emergency.

emf Abbreviation for electromotive force.

emission 1. The radio waves radiated into space by a radio transmitter. 2. The process of ejecting electrons from the surface of a material under the influence of heat, radiation, or other causes.

emission characteristic A graph or other means of showing the relation between electron emission from a

EMISSION SPECTRUM

vacuum-tube electrode and the cause of the electron emission, such as the temperature, voltage, or current of the filament.

emission spectrum The spectrum showing the radiation emitted by a substance, such as the spectrum of light emitted when a metal is placed in an electric arc.

emissive power The time rate of emission of radiant energy in all directions per unit surface area of a radiating body at a given temperature. Also called *radiating power*.

emitron camera A British television camera employing a cathode-ray tube and electronic scanning. An image of the scene being televised is produced by a lens on a mosaic light-sensitive screen inside the cathode-ray tube. Deflecting coils outside the tube cause an electron beam (produced by an electron gun) to scan the mosaic screen in parallel lines. The electron beam releases in turn the charge produced on each light-sensitive particle or cell of the screen, and this gives a varying signal proportional to the illumination on the screen element being scanned at each instant.

emphasizer A circuit or device that intentionally increases signal strength at certain audio frequencies.

empire cloth Cotton or linen cloth coated with linseed oil, used for insulating coils and other parts of electrical equipment.

empirical Based on actual measurement, observation, or experience.

emu Abbreviation for electromagnetic unit.

enameled wire Wire coated with an insulating layer of baked enamel.

enantiomorphic A term applied to certain classes of crystals that occur in two forms, in one of which the external faces and all internal properties are the mirror image of those in the other. Quartz and Rochelle salts are examples. For quartz, the two forms are called right-quartz and left-quartz.

end effect The effect of capacitance at the ends of an antenna. It requires that the actual length of a half-wave antenna be about 5 per cent less than half a wavelength, with this percentage increasing to about 6 per cent at frequencies above 50 megacycles.

end-fire array An array in which the elements are side by side, parallel, and all lying in the same plane, with the currents not in phase for the various elements. It radiates best along the line of the antennas.

endodyne reception A British term applying to reception of unmodulated code signals with a vacuum-tube circuit having a local oscillator differing slightly in frequency from the carrier signal and thus producing a beat signal in the audio range. Called *autodyne reception* in this country.

end-on directional antenna End-fire array.

energize To supply with power as necessary to provide normal and effective operation of transmitters, receivers, and other equipment.

energy Capacity for performing work. Energy due to the motion of a piece of matter is called *kinetic energy*. Energy due to the position of a piece of matter is called *potential energy*. Energy may be transmitted from one particle or system to another by mechanical, thermal, chemical, electrical or other processes, but the energy gained or lost due to transfer is always either kinetic or potential. Energy may be transferred from one form to another, but it cannot be created or destroyed.

energy product curve A curve obtained by plotting the product of the values of magnetic induction B and demagnetizing force H for each point on the demagnetization curve of a permanent-magnet material. It is usually shown with the demagnetization curve.

engine-driven generator A generator deriving its power from a gear or belt connection to an engine, as to a main aircraft engine.

EQUIVALENT CIRCUIT

engineer One whose training or experience is sufficient for a responsible position in some branch of engineering.

engineering The art and science of making natural sources of power useful to man in machines, structures, and products. Engineering has many branches, some of which are electrical, electronic, mechanical, civil, illuminating, chemical, industrial, highway, radio, telephone, telegraph, television, and automotive.

envelope 1. The glass or metal housing of a vacuum tube. 2. A curve drawn to pass through the peaks of a graph showing the wave form of a modulated radio-frequency carrier signal.

envelope delay In the transfer of an amplitude-modulated wave from one point to another in a system, the time of delay of the envelope of the wave. It is equal to the slope of the phase-shift angle plotted against angular frequency.

episcotister A rotating slotted or punched disk used to interrupt a light beam at an audio-frequency rate in modulated-beam photoelectric intrusion-detector systems to permit amplification of the phototube output.

epsilon The Greek letter ϵ , frequently used to represent the number 2.71828 . . . , which is the base of the natural system of logarithms.

equalizer Any combination of coils, capacitors, and/or resistors inserted in an audio-frequency amplifier circuit to change its frequency response in a desired manner.

equalizing current The current that circulates between two parallel-connected compound generators to equalize their output.

equilibrium A condition of balance. The equilibrium is stable when slight changes result in conditions tending to restore the original balance. Equilibrium is unstable when changes create conditions that tend to increase the changes and cause greater unbalance. Equilibrium is neutral when balance persists regardless of changes.

equilibrium potential The potential difference between an electrolyte and an immersed electrode when they have come to equilibrium.

equipotential Having the same potential at all points.

equipotential cathode A cathode to which heat is supplied by an independent heater element in a thermionic tube. Also called *indirectly heated cathode* or *unipotential cathode*.

equipotential line An imaginary line in space, having the same potential at all points.

equipotential space An imaginary volume in space, in which all points have the same potential.

equipotential surface An imaginary surface in space, on which all points have the same potential.

equisignal radio-range beacon A radio-range beacon that transmits two distinctive signals which may be received with equal intensity only in certain directions called equisignal sectors. Used for aircraft guidance.

equisignal sector The on-course region in which the two different signals from an equisignal radio-range beacon are received on an aircraft with equal intensity.

equivalent absorption The area of perfectly absorbing surface that will absorb sound energy at the same rate as the given object under the same conditions. The acoustic unit of equivalent absorption is the sabin.

equivalent circuit A relatively simple circuit arrangement of resistors, inductors, and/or capacitors which is electrically equivalent to a more complicated circuit or device. Used to simplify circuit analysis.

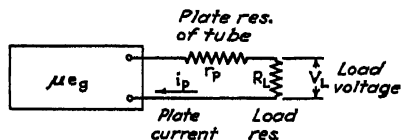

Equivalent circuit of a vacuum tube.

EQUIVALENT ELECTRON DENSITY

equivalent electron density In an ionized gas, the product of ion density by the mass ratio of an electron to an ion. When several different kinds of ions are present, the equivalent electron density is the sum of the individual equivalent electron densities.

equivalent height The virtual height of an ionized layer of the ionosphere.

equivalent loudness level The intensity level in decibels of a pure 1000-cycle tone that seems equivalent in loudness to the sound under consideration. The threshold of hearing for a 1,000-cycle tone is usually used as the reference level when specifying loudness levels in decibels. A decibel of change in level under these conditions is sometimes called a phon. Also called *loudness level*.

equivalent network A network that, under certain conditions of use, may replace another network.

equivalent resistance The concentrated or lumped resistance that would cause the same power loss as the actual small resistance values distributed throughout a circuit.

E region A region in the ionosphere, between about 55 and 85 miles above the surface of the earth, which contains ionized layers capable of bending or reflecting radio waves.

erg The absolute centimeter-gram-second unit of energy and work. It is the work done when a force of one dyne is applied through a distance of one centimeter. One foot-pound is equal to 13,560,000 ergs.

escutcheon The ornamental metal, wood, plastic, or other framework used around a radio tuning dial, control knob, or other panel-mounted part in a radio receiver, television receiver, audio-frequency amplifier, or other equipment.

esr Abbreviation for effective signal radiated.

EST Abbreviation for Eastern Standard Time.

esu Abbreviation for electrostatic unit.

ETA Abbreviation for estimated time of arrival.

ETD Abbreviation for estimated time of departure.

ether A hypothetical medium that has been supposed to fill all space and serve as a medium of propagation for light, radio waves, and other forms of radiation. Its existence is at present denied by many scientists.

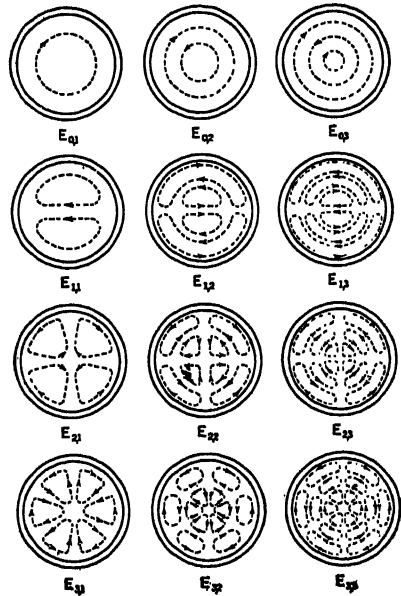

Magnetic force patterns for *E* waves in circular wave guides. These waves are propagated through guides at frequencies of the order of 1,000 megacycles and higher.

E wave Another designation for *TM* wave (transverse magnetic wave), one of the two classes of electromagnetic waves that can be sent through wave guides. An *E* wave possesses longitudinal electric force, whereas an *H* wave (*TE* wave) possesses longitudinal magnetic force. The first subscript numeral following the letters gives the order of the wave and corresponds to the number of vibrations or half-period variations of the field along the diameters of a circular wave guide or along the *x*

coordinate of a rectangular guide. The second subscript numeral gives the mode of the wave and corresponds to the number of vibrations or half-period variations of the field in a radial direction between the center and the walls, counting the outermost (the wall or sheath) as one, or the number of vibrations along the y coordinate of a rectangular wave guide.

exalted-carrier receiver A receiver that counteracts selective fading by maintaining the carrier at a high level at all times. This minimizes the second-harmonic distortion that would otherwise occur when the carrier drops out while leaving most of the sidebands at their normal amplitudes. The receiver may have a local oscillator operating at the frequency of the incoming carrier, or may amplify the incoming carrier separately and recombine it with the sidebands.

excess sound pressure The total instantaneous pressure at a point in a medium containing sound waves, minus the static pressure that exists when no sound waves are present. The unit is the dyne per square centimeter. Also called *instantaneous sound pressure*.

excitation 1. Application of a signal to the input of a vacuum-tube amplifier stage. 2. Application of signal power to a transmitting antenna. 3. Application of voltage to the field coils of a motor, generator, electrodynamic loudspeaker, or other device that produces a magnetic field.

excitation anode An electrode used to maintain an auxiliary arc in the vacuum tank of a mercury-arc rectifier or similar tube.

exciter 1. That part of a directional transmitting antenna system which is directly connected to the source of power, as to the transmitter. 2. The crystal oscillator or self-excited oscillator that generates the carrier frequency of a transmitter. 3. The small auxiliary generator that provides field current for an alternating-current generator.

exciter lamp An intensely bright incandescent lamp having a concentrated filament, used in variable-area sound-on-film recording and in reproducing all types of sound tracks on film, as well as in some mechanical television systems. The term originated because this lamp excites the photoelectric cell.

exciting current The current that flows through the primary winding of a power transformer when no loads are connected to the secondary winding. It produces the magnetic field in the core and furnishes energy for the no-load power losses in the core.

exhaustion Removal of gases from a space, such as the bulb of a vacuum tube, by means of vacuum pumps.

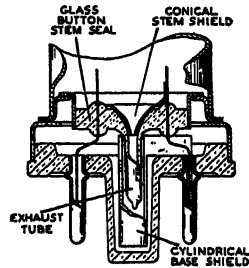

Exhaust tube in a metal tube.

exp An abbreviation sometimes used in equations to indicate that the quantity immediately following in brackets is to be considered as the exponent of e , which is 2.718, the base of the natural system of logarithms.

expansion 1. Widening the volume range of an audio-frequency signal, so that weak passages become weaker and loud passages become louder. 2. In facsimile, an increase in white-to-black amplitude range or frequency swing, occurring between two points in the system. 3. The developed result of an indicated operation in mathematics. Thus, the expansion of $(a + b)^2$ is $a^2 + 2ab + b^2$. 4. An enlargement, spreading out or increase in volume, so as to occupy more space.

expansion chamber An enclosure containing air supersaturated with water vapor by sudden expansion, in which

EXPEDANCE

rapidly moving particles are revealed by streaks of droplets called cloud tracks. Also called *cloud chamber* or *fog chamber*.

expedance A little-used term equivalent to negative impedance.

experimental period The time between 12 midnight and local sunrise. This period may be used for experimental purposes in testing and maintaining apparatus by the licensee of any standard broadcast station on its assigned frequency and with its authorized power, provided no interference is caused to other stations maintaining a regular operating schedule within such period.

experimental television broadcast station A station licensed for experimental transmission of transient visual images of moving or fixed objects for simultaneous reception and reproduction by the general public.

exploring coil A small coil used to measure a magnetic field. It is connected to a ballistic galvanometer or other instrument, and gives an indication when the magnetic field or the position of the coil in the field is suddenly reversed. Also called *flip coil*.

exponential Pertaining to exponents or to an expression having exponents. A quantity varying in an exponential manner is increasing according to the square or some other power of a factor instead of linearly.

exponential curve A curve representing the variation of an exponential function.

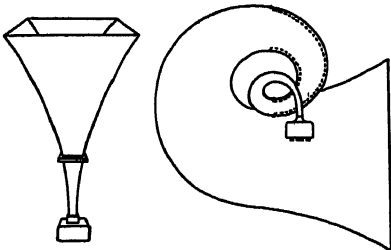

Exponential horns—straight and curled.

exponential horn A horn whose cross-sectional area varies exponentially with its length according to the relation $S/S_0 = e^{Tx}$, where S is the cross-sectional area at a distance x from the throat of the horn, S_0 is the cross-sectional area at the throat, and T is a constant that determines the rate of taper of the horn.

exponential quantity A quantity in which the rate of increase (or decrease) of the quantity is proportional to the quantity itself. The discharge current of a capacitor through a noninductive resistor is an exponential quantity.

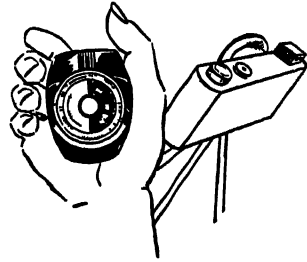

Photoelectric exposure meter.

exposure meter An instrument used to measure the intensity of light reflected from an object, for the purpose of determining the proper camera exposure. Modern highly accurate exposure meters use photoelectric cells.

extension cord A pair of wires having a plug at one end and an outlet at the other, used to bring electric power to a point at some distance from the usual outlet.

extensometer An instrument in which a change in dimensions of a specimen under test produces a change in capacitance that is amplified and recorded.

external resistance The resistance that is connected externally between the terminals of a battery or other generator. The resistance that is inside the battery or generator is the internal resistance.

EXTRAPOLATE

extinction potential The lowest value to which the plate voltage of a gaseous tube can be reduced from a higher value under given conditions without stopping the flow of plate current.

extraordinary component That component of light which is plane polarized and which passes through a Nicol prism. The ordinary component does not pass through the prism.

extraordinary ray When light is sent through a doubly refracting crystal, it is separated into two components that are at right angles to each other

and are known as the extraordinary ray and the ordinary ray.

extraordinary wave One of the two components into which a radio wave is divided in the ionosphere by the magnetic field of the earth. Sometimes called *X wave*. The other component is the ordinary wave, or *O wave*.

extrapolate To extend the range of known values by estimating. Interpolate means to estimate missing values between those which are known.

F

F Abbreviation for filament.

f Letter symbol for frequency.

F+ See *A+*.

F- See *A-*.

°F Symbol for degrees Fahrenheit.

facility 1. Any facility used as an aid of air navigation, including landing areas and lights. 2. Any apparatus or equipment for disseminating weather information, for signaling, for radio direction finding, or for radio or other electrical communication.

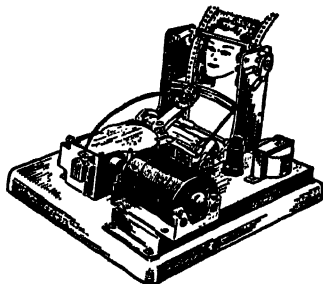

Facsimile printer.

facsimile A system of communication in which images are transmitted for record reception. Type A facsimile is a system of facsimile communication in which images are built up of lines or dots of constant intensity. Type B facsimile (telephotography, photoradio, etc.) is a system of facsimile communication in which images are built up of lines or dots of varying intensity.

facsimile broadcast station A station licensed to transmit images of still objects for record reception by the general public.

facsimile receiver The apparatus employed to translate the signal from a facsimile communication channel into a facsimile record of the subject copy.

facsimile reception Reception of a radio signal corresponding to the subject copy being transmitted in a facsimile system.

facsimile recorder That part of a facsimile receiver in which the picture signal in its final form is systematically registered on a record sheet as a facsimile of the subject copy.

facsimile-signal level The maximum signal power or voltage created by the scanning of the subject copy, as measured at any definite point in a facsimile system. It may be expressed in decibels with respect to a reference level. With positive modulation it will correspond to picture white, while with negative modulation it will correspond to picture black.

facsimile transient A damped oscillation that may be superimposed on the signal envelope as a result of distortion when a signal undergoes a sharp amplitude change. It may appear as tailing or as overthrow or underthrow distortion.

facsimile transmission The electric transmission, either over wires or by radio, of a graphic record having a limited number of shade values (usually only black and white). Picture transmission involves a gradation of shade values.

facsimile transmitter The apparatus employed to translate the subject copy into signals suitable for delivery to the communication system.

fade To change gradually in signal strength. The signal associated with a sound or television program is faded in by making it gradually stronger, and is faded out by reducing its volume gradually to zero.

fade in To increase signal strength gradually in a sound or television

channel being connected to a system. It is the opposite of fade out.

fade out To reduce signal strength gradually in a sound or television channel during changeover to another channel. It is the opposite of fade in.

fadeout 1. Failure of radio waves to arrive at a location either because of magnetic storms, atmospheric disturbances, or other conditions along the transmission path. 2. Intentional and gradual disappearance of a television scene, produced at one television camera or its control circuit prior to or during changeover to another television camera.

fader A multiple-unit volume control used in radio for gradual changeover from one microphone or audio channel to another, in television for changeover from one camera to another, and in motion-picture projection for changeover from one projector to another. In each case, the level is held essentially constant because one section of the fader increases signal level in its channel while the other fader section reduces signal level a corresponding amount.

fading A variation in the signal intensity produced at a given location by a radio transmitting station, due to fluctuations or changes in the transmission paths.

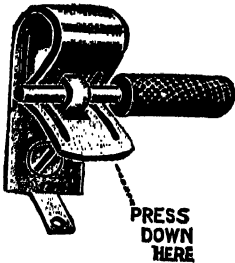

Fahnestock clip, with wire inserted.

Fahnestock clip A spring-type terminal to which a temporary connection can readily be made.

Fahrenheit A temperature scale in which the freezing point of water is 32° and the boiling point of water is 212° above its zero (for normal atmos-

pheric pressure). Absolute zero is -459.6°F. To change degrees Fahrenheit to degrees centigrade, subtract 32 and then multiply the result by $\frac{5}{9}$. Named after Gabriel Fahrenheit, German physicist (1686-1736).

fan antenna An antenna in which the pickup wires are vertical and spread out fanwise from a common lower junction.

farad The basic unit of capacitance. A capacitor has a capacitance of one farad when a voltage change of one volt per second across it produces a current of one ampere. The farad is too large a unit for practical work; hence smaller units are generally used. The microfarad is equal to one millionth farad, while the micromicrofarad is equal to one millionth microfarad.

faraday The number of coulombs required for an electrochemical reaction involving one electrochemical equivalent. It is equal to 96,500 coulombs.

Faraday cylinder A hollow insulated metal cylinder, almost completely closed, used to collect charged particles. The total charge of the particles then appears on the surface of the cylinder, where it can be measured. Also called *Faraday ice pail*, because Faraday originally used a tin ice pail for this purpose.

Faraday dark space The nonluminous region separating the negative glow from the positive column in a Crookes tube or other gaseous discharge tube. The position of the dark space in the tube varies with the degree of exhaustion or vacuum.

Faraday effect When a plane polarized beam of light passes through certain transparent substances in a direction parallel to the lines of a strong magnetic field, the plane of polarization is rotated a certain amount.



Faraday ice pail, used in demonstrating electrostatic principles.

Faraday ice pail A Faraday cylinder.

FARADAY'S BAG

Faraday's bag A conical bag used to demonstrate that an electric charge always remains on the outside surface of a conductor. When the bag is charged on the outside, then pulled inside out, the charge will still be on the outside.

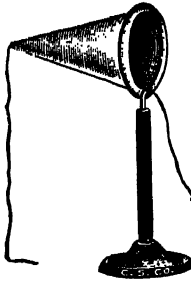

Faraday's bag.

Faraday screen A Faraday shield.

Faraday shield A network of parallel wires connected to a common conductor at one end of the wires (like a comb) to provide electrostatic shielding without affecting electromagnetic waves. The common conductor is usually grounded. A Faraday shield is often placed around a loop antenna to eliminate electrostatic pickup of signals, or placed between two coils to eliminate stray capacitance. Also called *Faraday screen*.

Faraday's laws 1. In electrolysis, the quantity of a substance deposited in a given time is proportional to the current. 2. In electrolysis, the quantities of different substances deposited by the same current in the same time are proportional to their electrochemical equivalents. 3. In electromagnetic induction, the electromotive force induced in a circuit is proportional to the rate at which the flux linkages of the circuit are changing. (Though usually associated with the name of Faraday, this law was not proposed by him.)

Faraday's wire cylinder A cylinder of wire gauze, closed at one end, used to shield a device from an external electric field. Also called *Faraday shield* or *Faraday screen*.

faradic current An intermittent and nonsymmetrical alternating current obtained from the secondary winding of an induction coil, used in electrobiology.

faradism See *faradization*.

faradization The treatment of nerves and muscles with an intermittent alter-

nating current (faradic current) obtained from the secondary winding of an induction coil.

faradmeter An instrument for measuring capacitance, the scale of which is usually graduated in microfarads.

Farnsworth image dissector tube A special cathode-ray tube for use in television cameras, developed by P. T. Farnsworth.

fathom A measure of length, equal to 6 feet, used chiefly in specifying the depth of water.

fathometer A direct-reading device for determining the depth of water in fathoms or other units by sonic (sound) or supersonic (above audibility) waves reflected from the ocean bottom. Electronic equipment is employed to convert the elapsed time between the release and arrival of a wave pulse into the distance traveled by the wave to the bottom and back.

fatigue The gradual decrease in some characteristic property due to external causes, such as the reduction in the photoelectric sensitivity of certain light-sensitive surfaces with prolonged exposure to light.

fault A break, ground, or insulation defect in a telephone line, cable, or other conductor.

fault current The current flowing through a fault in the insulation of a circuit. It may be a small current ordinarily classed as leakage, or the large current of a short circuit, or a direct ground.

FCC Abbreviation for Federal Communications Commission.

Fe Chemical symbol for iron.

Federal Communications Commission A board of seven commissioners appointed by the President under the Communications Act of 1934, having the power to regulate all electrical communication systems originating in the United States, including radio, television, facsimile, telegraph, telephone, and cable systems.

feed 1. To supply a signal to the input of a circuit. 2. To transmit a program over telephone lines to other radio stations in a network or to any listening point.

feedback The returning of a portion of the output of an amplifier stage to the input of that stage or a preceding stage either electrically or acoustically, resulting in a change in amplification and sometimes also in squealing or howling in audio-frequency systems. When the signal is fed back in phase with the input signal, positive feedback or regeneration exists and increases the amplification, causing howling in audio-frequency systems. When the signal is fed back out of phase with the input signal, negative feedback or degeneration exists and decreases the amplification, thereby improving the stability of the circuit.

feedback cutter In sound recording, a cutter in which a voltage generated by a pickup device actuated directly by movements of the cutting stylus is fed back into the amplifier system, usually to reduce distortion or stabilize the frequency-response characteristics.

feedback oscillator One of the many types of vacuum-tube oscillators employing positive feedback to maintain oscillation.

feeder 1. One of the wires or cables used to feed electrical energy from a source to a load or to a point from which it is distributed. 2. A conductor connecting an antenna with radio transmitting or receiving equipment is sometimes called a feeder.

female The recessed portion of a device into which another part fits. Thus, in a two-piece connector, the male portion has prongs that fit into corresponding holes in the female portion.

Ferrocarril core A core consisting of finely divided particles of magnetic material mixed with a suitable bonding material and pressed into shape. Used with radio-frequency coils at frequencies up to several hundred megacycles, permitting a reduction in turns for a given inductance without excessive losses due

to eddy currents. Also called *powdered iron core*.

ferromagnetic material A material having a permeability that is considerably greater than the permeability of a vacuum and varies with the magnetizing force. Often called simply a magnetic material. The various forms of iron, steel, cobalt, nickel, and their alloys are examples.

ferrometer An instrument for making permeability and hysteresis tests of iron and steel.

ferrous Pertaining to iron, and particularly to iron compounds in which the iron is bivalent.

fiber A hard, tough insulating material generally consisting of paper and cellulose compressed into rods, sheets, or tubes.

fiber needle A playback point or phonograph needle made from fiber. Being soft, it gives lower scratch noise, but should not be used on instantaneous recordings because of its high coefficient of friction.

fititious power The square root of the difference of the squares of the apparent power and the active power. It is the same as reactive power if current and voltage are sinusoidal. The unit of fititious power is the fititious volt-ampere.

fideliy The degree with which a system or portion of a system accurately reproduces at its output the essential characteristics of the signal that is impressed on its input.

field 1. In television, the area or solid angle picked up by the lens system of the television camera. 2. In television, the area covered during one vertical sweep of the scene by the scanning element. In normal scanning where one line touches the next, the field is the entire scene being televised. In double interlaced scanning, the field is half the area of the scene. In triple interlaced scanning, the field is one-third the area of the scene. 3. A general term applying to a region

FIELD COIL

under the influence of some physical agency, such as electricity, magnetism, or a combination, produced by an electrically charged object, by electrons in motion, or by a magnet.

field coil A suitably insulated winding mounted on a field pole to magnetize it and produce a constant-strength magnetic field. Used in electric motors, generators, electrodynamic loudspeakers, etc.

field distortion Magnetic field distortion existing between the north and south poles of a generator due to the counter electromotive force in the armature windings.

field equation One of the equations that specify the properties of a field of force, such as the Maxwell equations for electromagnetic fields.

field frequency In television, the number of complete downward sweeps of the scanning element per second. In interlaced scanning, it represents the number of times per second that the frame area is fractionally scanned.

field intensity 1. The value of the vector at a point in the region occupied by a vector field. Also called *field strength*. In radio, it is the effective value of the electric field intensity in microvolts or millivolts per meter, produced at a point by radio waves from a particular station. Unless otherwise specified, it is assumed that the measurement is made in the direction of maximum field intensity. 2. The amount of magnetic flux produced at a particular point by an electromagnet or permanent magnet.

field pole A structure of magnetic material on which a field coil of a motor, generator, or other electromagnetic device may be mounted.

field rheostat A variable resistance connected to the field coils of a motor or generator and used to vary the field current.

field strength The value of the vector at a point in the region occupied by a vector field, such as by radio waves, electric lines of force, or magnetic lines of force. Also called *field intensity*.

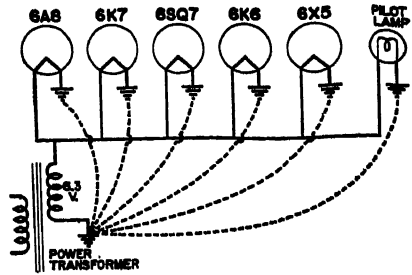

Dotted lines show how filament circuits are completed by chassis connections.

filament The resistance wire through which filament current is sent in a thermionic vacuum tube to produce the heat required for electron emission. In filament-type tubes, the emission is directly from the incandescent filament wire and the filament is therefore serving also as the cathode. In heater-type tubes, the filament supplies heat to a separate surrounding cathode.

filament circuit The complete circuit through which filament current flows from the filament voltage source in radio or electronic equipment to the filaments of vacuum tubes and pilot lamps.

filament current The current supplied to the filament of a tube for heating purposes.

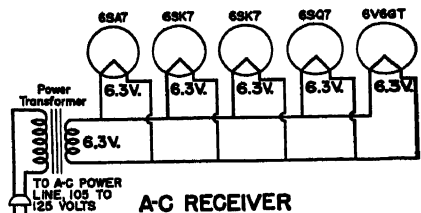

A-C RECEIVER

Filaments in parallel.

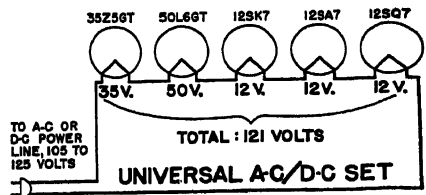

TOTAL : 121 VOLTS

UNIVERSAL A-C/D-C SET

Filaments in series.

FILTER DISCRIMINATION

filament emission Liberation of electrons from a heated filament wire in a vacuum tube.

filament power supply The means for supplying power with proper regulation to the filament or heater of a vacuum tube for heating purposes.

filament resistance The resistance in ohms of the filament of a vacuum tube or incandescent lamp. For tungsten or other metal filaments, the resistance increases considerably with temperature, so that the hot resistance value is many times the cold resistance value. With carbon filaments, the resistance decreases as temperature is increased.

filament rheostat A variable resistance used in series with the filament of a vacuum tube to regulate the amount of filament current.

filament saturation The condition in which the plate current of a vacuum tube cannot be further increased by increasing the filament voltage and hence cathode temperature at a given value of plate voltage. The effect is due to the space charge formed near the cathode. Also called *temperature saturation*.

filament transformer A small transformer used exclusively to supply filament current for one or more vacuum tubes.

filament voltage The voltage applied to the filament terminals of a vacuum tube to send filament current through the filament for heating purposes. The correct filament voltage for a particular tube is given in tube charts.

filament winding A secondary winding provided on a power transformer to furnish alternating filament voltage for one or more vacuum tubes in radio or electronic equipment.

filler metal Material to be added in making a weld.

film The layer adjacent to the valve metal, in an electrochemical valve, in which is located the high voltage drop when current flows in the direction of high impedance.

film scanning The process of converting movie film into corresponding electrical signals that can be transmitted by a television system and reproduced as movies at television receivers.

filter In general, a device that separates some components or ingredients from others. An optical filter transmits only certain wavelength ranges in the visible, ultraviolet, and infrared spectrums. An electric filter is a selective circuit network designed to pass direct current or currents within a continuous band of frequencies, while substantially reducing the amplitudes of currents at undesired frequencies. An acoustic filter suppresses certain audio frequencies.

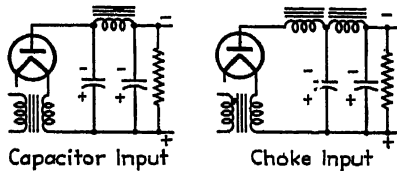

Basic filter circuits using capacitor input and choke input.

filter attenuation band A frequency band in which the attenuation constant of a filter is not zero. It thus represents frequencies that are attenuated or suppressed by a filter. Also called *filter stop band*.

filter capacitor A capacitor used in a power-pack filter system to provide a low-reactance path for alternating currents, without affecting direct currents. Electrolytic capacitors are generally used for this purpose, and must therefore be connected with correct polarity.

filter choke An iron-core inductor (coil) used in a power-pack filter system to pass direct current while offering high impedance to pulsating or alternating currents.

filter discrimination In a wave filter, the difference between the minimum insertion loss at any frequency in a filter attenuation band and the maximum insertion loss at any frequency in the operating range of a filter transmission band. The insertion loss is

FILTER PASS BAND

determined under conditions of normal filter use.

filter pass band A filter transmission band.

filter stop band A filter attenuation band.

filter transmission band A frequency band in which, if the filter is non-dissipative or dissipation is neglected, the attenuation constant is zero. Also called *filter pass band*.

filtration The process of absorbing some X-ray wavelengths (usually the longer wavelengths) by placing in the path of the X rays a selectively absorbing medium such as copper or aluminum.

finder A camera accessory that shows with more or less accuracy the actual field of action being covered by the camera. Television cameras are made with many different types of finders, both optical and electronic.

finished blank The finished crystal product after the completion of all processes. This may include electrodes adherent to the crystal blank. Also called *piezoid*.

finite Having fixed and definite limits or magnitudes.

firing potential The grid-cathode voltage required in a gaseous triode to make the tube conductive.

first detector That stage in a superheterodyne receiver in which the radio-frequency signal from the local oscillator is combined with the incoming modulated radio-frequency signal to produce the modulated intermediate-frequency signal. Also called the *mixer stage* or the *mixer-first detector stage*.

fishbone antenna A directional antenna consisting of a plane array of antennas arranged transversely along both sides of a transmission line much like the skeleton of a fish.

fishing wire A tempered steel wire, usually of rectangular cross-section, which is pushed through a conduit or between a partition or other inaccessible space

and used to pull electric wires through that space. Also called *snake*.

fishpaper A type of fiber used in sheet form for insulating purposes where high mechanical strength is required, as in insulating transformer windings from the transformer core, insulating field coils from field poles, or insulating armature conductors of a rotating machine from the armature.

five-electrode tube A pentode.

fix A determination of position at sea or in the air by means of radio direction finders or other navigational equipment.

fixed bias A constant value of bias voltage, such as obtained from a battery, generator, or other power supply.

fixed capacitor A capacitor having a definite capacitance value that cannot be adjusted.

fixed crystal A crystal detector in which the contact position is not adjustable.

fixed public press service A limited radio-communication service carried on between point-to-point telegraph stations, consisting of transmissions by fixed stations open to limited public correspondence, news items, or other material related to or intended for publication by press agencies, newspapers, or for public dissemination.

fixed public service A radio-communication service carried on between fixed stations open to public correspondence.

fixed resistor A resistor having a definite resistance value that cannot be adjusted.

fixed service A service carrying on radio communication of any kind between fixed points, with the exception of the broadcasting service and special service.

fixture splice A splice used for connecting relatively small wire (as that used in electric fixtures) to a heavier wire. The small wire is wound in close turns around the large wire, after which the end of the large wire is bent tightly back over the coils of the small wire.

flame microphone A microphone in which the action of sound waves on a flame changes the resistance between two electrodes in the flame.

flared radiating guide An arrangement for radiating waves from a guide by removing the sheath of the guide for a short distance and attaching metal flanges to the resulting ends of the guide to accentuate the flow of radiant energy in a desired direction, such as uniformly in all directions in a horizontal plane.

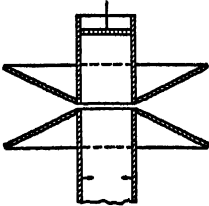

Flared radiating guide. When vertically mounted, it radiates energy uniformly in all directions in a horizontal plane, as usually required for broadcasting.

flare factor A number expressing the degree of outward curvature of the horn of a loudspeaker.

flash arc A sudden increase in the emission of large thermionic vacuum tubes, probably due to irregularities in the cathode surface. Sometimes causes complete breakdown. Also called *Rocky Point effect*.

flasher A device that rapidly and automatically lights and extinguishes electric lamps. It is generally either a motor-driven switch or a thermal switch.

flashing over Accidental formation of an arc over the surface of a rotating commutator from brush to brush. Usually caused by faulty insulation between commutator segments.

flash magnetization Magnetization of a ferromagnetic object by a current impulse of such short duration that magnetization does not penetrate beyond a shallow surface layer of the material. Sometimes used in electromagnetic crack detectors.

flashover A disruptive discharge around or over the surface of an insulator.

flash test A method of testing insulation by applying momentarily a voltage much higher than the working voltage.

flash welding Welding in which an arc is first struck between the pieces to be welded. After the ends are so heated, they are brought together and the weld completed by pressure after the current has been cut off.

flat top The horizontal portion of an antenna.

flat-top antenna An antenna having two or more lengths of wire parallel to each other and in a plane parallel to the ground.

flat-top response A response characteristic in which a definite band of frequencies is transmitted uniformly. In intermediate-frequency transformers, it is obtained by tuning the primary and secondary resonant circuits to slightly different frequencies. Also called *band-pass response*.

F layer An ionized layer in the *F* region of the ionosphere. It exists in the night hemisphere and in the weakly illuminated portion of the day hemisphere. Over the intensely illuminated portion of the day hemisphere, it divides into two layers, the F_1 and F_2 layers.

F_1 layer The lower of the two ionized layers normally existing in the *F* region in the day hemisphere.

F_2 layer The higher of the two ionized layers normally existing in the *F* region in the day hemisphere.

Fleming's rule If the thumb, first and second fingers are extended at right angles to one another, with the thumb representing the direction of motion, the first finger representing the direction of magnetic lines of force, and the second finger representing the direction of the current, then (a) the right hand will give the correct relations for a conductor in the armature of a generator, (b) the left hand will give the correct relations for a conductor in the armature of a motor. Note that this rule applies to so-called conventional cur-

FLEMING VALVE

rent flow, which is the opposite of electron flow.

Fleming valve Early name for a two-electrode thermionic vacuum tube used as a detector.

Flewelling circuit An early radio circuit in which one tube serves simultaneously as a detector, amplifier, and local oscillator.

flexible coupling A device for connecting two shafts end to end and permitting rotation even though the two shafts are not exactly aligned.



Flexible coupling.

flexible metal conduit Flexible metal tubing used to protect insulated wires in buildings or for bringing electric power to electric or electronic equipment. Usually called BX.

flexible resistor A wire-wound resistor having the appearance of a flexible lead. It is made by winding Nichrome resistance wire around a length of asbestos or other heat-resistant cord, then covering the winding with a braided insulating covering. This covering is generally RMA color coded to indicate the resistor value. The body color gives the first figure, the three-thread color gives the second figure, and the one-thread color gives the number of zeros following the first two figures, with the colors being interpreted as in the resistor color code.

flexible shaft A shaft that transmits rotary motion at any angle up to about 90 degrees. Used in electronic equipment to permit mounting adjustable controls at optimum positions with respect to other parts while still securing desirable groupings of controls on the panel.

flicker Erratic movement of a reproduced television picture, or visible effects revealing that the viewed picture is composed of stationary lines or frames.

flicker effect Small variations in the plate current of a thermionic vacuum tube, believed to be due to random emission of positive ions by the cathode.

flicker photometer A photometer in which illumination from the light source being measured and a standard light source is observed by the eye alternately in rapid succession. When the standard source has been made equal to the other, the flickering effect disappears.

flight test station A radio station used for the transmission of essential communications in connection with the test flights of aircraft. It may be authorized for operation as a fixed station on the ground or for operation on board aircraft subject to test.

Flinders bar A bar of soft iron placed in the correct position near a compass to correct errors due to variation of the vertical component of the earth's magnetism in different parts of the world.

flip coil A small coil used to measure a magnetic field. It is connected to a ballistic galvanometer or other instrument, and gives an indication when the magnetic field or the position of the coil in the field is suddenly reversed. Also called *exploring coil*.

flip-flop circuit A direct-coupled multivibrator circuit with two conditions of stable equilibrium. Known as *Eccles-Jordan circuit*.

floating battery A storage battery connected permanently in parallel with another power source. The battery normally handles only small charging or discharging currents, but takes over the entire load upon failure of the main supply.

floating carrier system A method of radio transmission in which the percentage modulation is held constant by varying the amplitude of the carrier wave to offset variations in the strength of the modulating wave.

floating charge Continuous charging of a storage battery at a low current value to keep the battery fully charged while it is standing idle or on light duty.

floating grid A vacuum-tube grid that is not connected to any circuit. It assumes a negative potential with re-

- spect to the cathode, due to electrons hitting the grid wires.
- float switch** A switch actuated by a float at the surface of a liquid.
- flock** Finely divided felt used on phonograph turntable surfaces, underneath microphone stands, and in similar locations where a nonscratching surface is desired. It is sifted over a layer of cement applied to the surface.
- floor projection** In facsimile, the optical method in which the subject copy is completely illuminated and the scanning spot is delineated by an aperture between the subject copy and the light-sensitive device.
- flow** Passage of electrons (a current) through a conductor or through space between electrodes.
- fluctuation noise** Noise due to fluctuation of voltage.
- fluctuation voltage** Small voltage variations occurring in a thermionic tube due to such causes as thermal agitation, shot effect, or flicker effect.
- fluoremeter** An instrument for measuring the intensity of X rays or ultraviolet light by the fluorescence produced, or for measuring fluorescence effects directly.
- fluorescence** Emission of light by a material only during excitation by some other source, such as by electrons, ultraviolet light, or X rays. When the glow of light persists after the excitation is removed, the effect is called phosphorescence.
- fluorescent** Showing or due to fluorescence.
- fluorescent lamp** An artificial source of light, basically an electric discharge lamp, in which ionization of the gas produces radiation that activates the fluorescent material on the inside of the glass tubing. The radiant energy from the electric discharge is transferred by suitable materials (phosphors in the fluorescent coating) into wavelengths giving more light (higher luminosity).
- fluorescent material** A material that fluoresces readily when exposed to electron beams, X rays, radium, or other radiation.
- fluorescent roentgen rays** Secondary roentgen rays (X rays) whose wavelengths are characteristic of the substance that emits them.
- fluorescent screen** A sheet of suitable material coated with a substance that fluoresces visibly when hit by an electron beam, X rays, or radium rays. In a cathode-ray tube it is usually a coating on the inside surface of the glass envelope at the large end of the tube.
- fluoroscope** A device consisting of a fluorescent screen mounted either separately or in conjunction with an X-ray tube. The shadows of objects interposed between the tube and the screen are made visible on the screen by the X-ray radiation. Also called *roentgenoscope*.
- fluoroscopy** The use, in diagnosis, testing, etc., of a fluorescent screen that is activated by X rays (roentgen rays). Also called *roentgenoscopy*.
- flush receptacle** A receptacle or outlet that is recessed in a wall, so that only the plate extends beyond the surface of the wall.
- flush-type instrument** A meter designed to be mounted with its face projecting only slightly beyond the front of the panel.
- flutter** A distortion occurring in sound reproduced from movie film when there is nonuniform motion of the film feed mechanism in the sound head, or occurring in a recording system due to nonuniform speed of the recorder or reproducer turntable.
- flux** 1. A material used to promote fusion or joining of metals in soldering, welding, or smelting. Rosin is widely used as a flux in electric soldering. 2. A general term used to designate collectively all the electric or magnetic lines of force in a region. 3. The flux through a surface in any vector field is the integral over the surface of the product of a surface element and the

FLUX DENSITY

normal component of the vector at that element.

flux density 1. The number of electric or magnetic lines of force per unit area at right angles to the lines. 2. The sound energy transmitted per unit of time in a specified direction through a unit area perpendicular to this direction at a point. It may be expressed in ergs per second per square centimeter or in watts per square centimeter. Also called *sound energy flux density* or *sound intensity*.

fluxgraph A machine that automatically plots on paper the magnetic field strength at various points in the vicinity of a coil. In one type, a search coil rotating at 1,800 revolutions per minute is mounted on a carriage that moves toward and away from the coil. When the voltage induced in the search coil reaches a predetermined value, an electronic circuit causes a stylus to mark on a paper disk the position of the search coil at that instant.

flux linkage A value obtained by multiplying the number of turns in a coil by the number of magnetic lines of force passing through the turns.

fluxmeter An instrument for measuring magnetic flux. Its scale is usually graduated in the number of magnetic lines of force passing through a given area. In one form it is a ballistic galvanometer having a moving system that remains at rest at any position, used with a suitable exploring coil.

fly-back The portion of the time base in the operation of a cathode-ray tube in which the spot is returning to the starting point.

flying spot The moving spot of light that scans the subject being televised in a mechanical television system.

f-m Abbreviation for frequency modulation. Same abbreviation used for noun and adjective.

f number A lens rating expressing the brightness of the image in relation to the aperture (useful area) of a lens, obtained by dividing the focal length of the lens by the effective diameter of

the lens. The lower the f number, the shorter is the exposure required or the lower is the illumination needed for satisfactory results with a television camera or ordinary camera. Usually expressed in the form $f:16$ or $f/16$.

focal length The distance between the optical center of a lens and its principal focus (the point at which light rays meet when coming from an infinite distance).

focal spot The small area of an X-ray tube target upon which the cathode rays (high-speed electrons) are concentrated, and from which the X rays proceed.

focus The point toward which rays of light converge to form an image after passing through a converging lens.

focusing The act of moving an optical lens back and forth until a sharp image is obtained, or the corresponding adjustment of the electron lens in a cathode-ray tube to secure a sharp image on the luminescent screen.

focusing coil A coil surrounding the neck of a cathode-ray tube or television camera tube, used to provide a magnetic field, parallel to the electron beam, that controls the cross-sectional area of the beam at the fluorescent screen.

focusing control The control that adjusts the size of the visible spot produced on the screen of a cathode-ray tube in a television system or an oscilloscope. In electromagnetic focusing, this control adjusts the current flowing through the focusing coil. In electrostatic focusing, this control adjusts the value of the high direct voltage applied to a focusing electrode in the electron gun inside the tube.

focusing electrode An electrode to which a potential is applied to control the cross-sectional area of the electron beam in a cathode-ray tube.

fog chamber An enclosure containing air supersaturated with water vapor by sudden expansion, in which rapidly moving particles are revealed by streaks of droplets called cloud tracks.

Also called *cloud chamber* or *expansion chamber*.

foil A thin flexible sheet of aluminum, lead, tin, or other metal. It is used extensively in radio for the plates of fixed capacitors and sometimes also for shielding purposes.

folded cavity An arrangement used in a klystron repeater to make the incoming wave act on the electron stream from the cathode at several places and produce a cumulative effect. In like manner, the cavity serving as the catcher of the klystron may be folded so that the velocity-modulated electrons have several opportunities for conversion into waves that are fed into the outgoing guide.

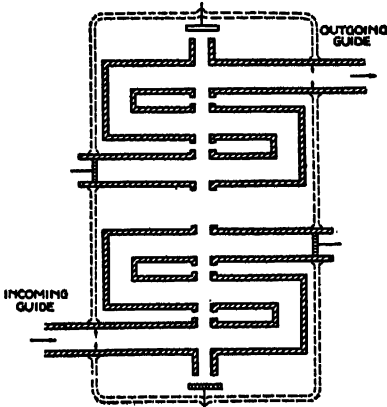

Folded cavities in a repeater for a wave guide.

foot-candle The unit of illumination when the foot is taken as the unit of length. It is the illumination produced at a surface all points of which are one foot away from a uniform point source of one candle, or the illumination on a surface one square foot in area on which there is a uniformly distributed flux of one lumen.



foot-lambert A unit of brightness equal to $1/\pi$ candle per square foot. It is therefore equal to the uniform brightness of a perfectly diffusing surface emitting or reflecting light at the rate of one lumen per square foot.

foot-pound A practical English unit of energy and work, equal to the work done in raising one pound a height of one foot against the force of gravity.

force Any physical cause that is capable of modifying the motion of a body.

forced oscillation Oscillation in which periodic forces outside a body or system determine the period or frequency of the oscillations.

forced vibration A nonresonant vibration produced in a body or system by some external vibrating or oscillatory force, which also controls the frequency of the vibration.

force factor 1. In an electrochemical transducer, the complex value obtained by dividing the resulting force in the blocked mechanical system by the current in the electrical system, or by dividing the resulting open-circuit voltage in the electrical system by the velocity in the mechanical system. 2. In an electroacoustic transducer, the complex value obtained by dividing the resulting blocked pressure in the acoustic system by the current in the electrical system, or by dividing the resulting open-circuit voltage in the electrical system by the volume velocity in the acoustic system. Force factor is thus a measure of the coupling between two systems.

force pump An auxiliary air pump used to create a partial vacuum during evacuation of vacuum tubes, in order that a more effective pump of another type can take over and complete the evacuation.

forestry station A station used for radio communications necessary for the prevention and suppression of forest fires.

formation voltage The final impressed voltage at which the film is formed on the valve metal in an electrochemical valve or on the metal plate of an electrolytic capacitor.

form factor The ratio of the effective value of an alternating quantity to the average value during a half-cycle.

FORMICA

The form factor is about 1.11 for a pure sine wave.

Formica A phenolic compound having good insulating qualities.

forming 1. The process that results in a change in the impedance at the surface of a valve metal when voltage is first applied. Both electrolytic rectifiers and electrolytic capacitors must undergo initial forming. It produces a thin layer of gas on the surface of the positive electrode; this gas serves as the dielectric in electrolytic capacitors. 2. The initial processing of the plates in a storage battery, involving conversion of the active material to the correct chemical composition.

form-wound coil An armature coil that is formed or shaped over a fixture before being placed on the armature of a motor or generator.

Foster's reactance theorem The driving point impedance of a finite two-terminal electric network formed of dissipationless elements is a pure reactance. This theorem is used in solving electric-circuit problems.

Foucault currents Eddy currents.

Fourier theorem Any finite periodic motion may be analyzed into components, each of which is a simple harmonic motion of definite and determinable amplitude and phase.

four-wire circuit A circuit using two lines or channels so arranged that electric waves are transmitted in one direction only by one line or channel and in the other direction only by the other line or channel.

four-wire repeater A telephone repeater for use in a four-wire circuit, having two amplifiers, one for each side of the circuit.

fpm Abbreviation for feet per minute.

fps Abbreviation for feet per second.

fractional-horsepower motor Any motor built into a frame smaller than that for a motor having a continuous rating of 1 horsepower at about 1,800 revolutions per minute.

Frahm frequency meter A frequency meter consisting of a row of steel reeds, each having a different natural frequency. All are excited by an electromagnet that is fed with the alternating current whose frequency is to be measured. The reed whose frequency corresponds most nearly with that of the current vibrates. The frequency value is read on a scale adjacent to the row of reeds.

frame 1. In television, a single complete picture. In double interlaced scanning, the frame is produced by two successive fields, each including half the total area of the frame. 2. In facsimile, a rectangular area whose width is that of the available line and whose length is determined by the service.

frame frequency In television, the number of times per second that the picture area is completely scanned. In double-interlaced scanning, the frame frequency is half the field frequency since two downward sweeps are required to scan every element in the frame.

framer In facsimile, a device for adjusting the equipment so that the recorded elemental area bears the same relation to the record sheet as the corresponding transmitted elemental area bears to the subject copy in the direction of line progression.

framing 1. In a television system, adjustment of the picture to a desired position with respect to the field of view, generally a central position. 2. In facsimile, adjustment of the reproduced picture to a desired position in the direction of line progression.

framing control 1. In television, any of the controls that adjust the centering, width, or height of the reproduced image. 2. In facsimile, the control that shifts the picture horizontally.

Franklin antenna A type of short-wave antenna in which several half-wave sections are used one above the other, with coils between the sections to reverse the phase in alternate sections.

FREQUENCY CONSTANT

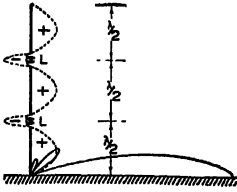

Franklin loaded vertical antenna, showing vertical radiation pattern for all directions (solid curves) and current distribution curves (dotted).

Fraunhofer lines The dark absorption lines of the solar spectrum, first studied by Fraunhofer in 1814.

free electron An electron within a substance or gas but not permanently attached to any one atom, and not restricted in its movements.

free grid A grid electrode that is left unconnected in a vacuum tube. It acquires a potential and exerts a control over plate current.

free oscillation 1. Oscillation of some physical quantity connected with a system that is under the influence of an internal force, a constant force having its origin outside the system, or both. A pendulum executes free oscillation under the influence of the constant force of gravity. 2. Oscillation that continues in a circuit after the impressed voltage has been removed.

free-point tester An instrument that permits transferring a tube from a radio receiver to a test panel at which either voltage or current measurements for any electrode of the tube are readily made by plugging a meter into appropriate jacks. Connections to the receiver are made by means of cord and plug inserted in the socket from which the tube was removed.

free-space field intensity The field intensity that would exist at a point in the absence of waves reflected from the earth or other reflecting objects.

free-space radar equation An equation that governs the radar signal when it is propagated between a radar and a reflecting object or target in otherwise empty space. The equation

gives the range of the target in terms of peak transmitter power, the maximum power gain of the radiator, the echo area or scattering cross-section of the target, the effective absorption cross-section of the receiving antenna, and the power generated at the receiver input. The maximum range of a radar depends on the fourth root of the transmitter power, the antenna gain and absorption area, the target-echo area, and the inverse of the minimum discernible received power.

free-space radiation pattern The radiation pattern that an antenna would have if in free space where there is nothing to reflect, refract, or absorb the radiated waves.

free wave A sound wave that is free from interference effects.

F region That region of the ionosphere extending from about 90 to 250 miles above the earth's surface.

frequency The number of complete cycles per unit of time for a periodic quantity such as alternating current, sound waves, or vibrating objects. Frequency is expressed in cycles per second. Frequency is the reciprocal of the period (the time for one cycle).

frequency allocation Assignment of available frequencies in the radio spectrum to specific stations and for specific purposes, to give maximum utilization of frequencies with minimum interference between stations. Allocations in the United States are made by the Federal Communications Commission.

frequency band A continuous range of frequencies extending between two limiting frequencies.

frequency changer A rotating machine that changes the power of an alternating-current system from one frequency to another, with or without a change in voltage or in the number of phases.

frequency constant The number relating a natural vibration frequency of a piezoid (finished crystal blank) to a linear dimension of the piezoid. The recommended symbol is H . When H

FREQUENCY CONVERSION

is expressed in kilocycle-millimeters, it is equal to the product of frequency in kilocycles and linear dimension in millimeters.

frequency conversion The process of converting the carrier frequency of a received signal from its original value to the intermediate-frequency value in a superheterodyne receiver.

frequency converter 1. Any circuit or device that changes an alternating current from one frequency to another. In a superheterodyne receiver, the oscillator and mixer-first detector stages together serve as the frequency converter. 2. A frequency changer of the rotating-machine type, in which the windings carrying the currents of different frequencies are in the same magnetic field.

frequency demodulation The process of converting a frequency-modulated signal into an audio-frequency signal.

frequency deviation In frequency modulation, the amount in cycles by which the instantaneous carrier frequency differs from the resting frequency.

frequency-deviation meter An instrument that indicates the number of cycles a transmitter has drifted from its assigned carrier frequency. The use of this instrument is required by the Federal Communications Commission at all broadcast stations.

frequency discrimination A type of distortion occurring when different frequency components in a signal undergo unequal amplification or attenuation.

frequency discriminator A discriminator circuit that converts a frequency-modulated signal into an amplitude-modulated signal or a varying direct current.

frequency distortion That form of distortion in which the relative magnitudes of the different frequency components of a wave are changed. As a result, the circuit or device amplifies or transmits unequally the different frequencies it is handling. This term excludes changes caused by nonlinear distortion.

frequency diversity The effect in which fading differs appreciably on frequencies that may be separated by as little as 500 cycles or less. In radiotelegraph service, this effect is utilized to advantage by varying the carrier frequency about 1,000 cycles above and below the assigned value continuously during code transmission, and by using receiving equipment that responds to a number of separate frequencies in such a way that the best one at any instant is utilized.

frequency divider A frequency changer used to divide by an integer the frequency of an alternating current.

frequency doubler A vacuum-tube stage having a resonant plate circuit that is tuned to the second harmonic of the input frequency. The output signal has twice the frequency of the input signal. Used in radio transmitters when it is undesirable or impossible to operate a crystal oscillator or master oscillator at the final high frequency required. It usually employs a class C amplifier that is adjusted so the plate circuit will have strong harmonics of the input signal.

frequency drift A slow change in the frequency of an oscillator or transmitter, usually due to temperature changes in circuit components.

frequency meter An instrument for measuring the frequency of an alternating current. Its scale is usually graduated in cycles, kilocycles, or megacycles.

frequency-modulated carrier current telephony Telephony involving the use of a frequency-modulated carrier signal transmitted over power-line wires or other wires.

frequency-modulated transmitter A radio transmitter that transmits a frequency-modulated wave.

frequency-modulated wave A sinusoidal wave in which the expression for instantaneous frequency contains a term whose wave form is similar to that of the intelligence signal to be transmitted.

FREQUENCY-SHIFT TRANSMISSION

frequency modulation A method of modulating a carrier-frequency current by causing the frequency of this current to vary above and below the no-modulation value in accordance with the audio or other modulation signal to be transmitted. The amplitude of the carrier remains constant at all times, resulting in relatively high efficiency because the transmitter can operate continuously at full power output. The amount of deviation in frequency above and below the assigned resting frequency is at each instant proportional to the amplitude of the audio or other signal being transmitted. The number of complete deviations per second above and below the resting frequency corresponds at each instant to the frequency of the audio or other signal being transmitted. The system is practically free of atmospheric and man-made interference, and there is little or no interference between stations; hence it can transmit a greater volume range and wider audio-frequency range than is being done with comparable amplitude-modulation systems. Frequency-modulation-station assignments are made in ultrahigh-frequency bands because each station requires a band width of about 100 kilocycles. At these frequencies, the range of a station is limited to about 100 miles.

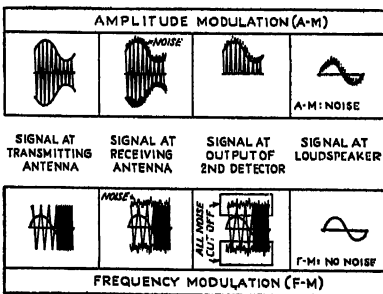

Frequency modulation compared with amplitude modulation.

frequency monitor An instrument for indicating the amount of deviation of the carrier frequency of a transmitter from its assigned value.

frequency multiplier A frequency changer used to multiply by an integer

the frequency of an alternating current. It may be a vacuum-tube amplifier stage or a rotating machine.

frequency range In a transmission system, the frequency band including those frequencies at which the system is able to transmit power without attenuating it more than an arbitrarily specified amount.

frequency record A phonograph record on which various frequencies throughout a desired audio-frequency range have been recorded for test purposes.

frequency regulator A device that functions to maintain the frequency of a generator at a predetermined value.

frequency relay A relay that is actuated by a change in frequency.

frequency response A rating indicating the range over which a circuit or device handles all frequencies uniformly. Thus, a loudspeaker may have an essentially flat response between 100 and 6,000 cycles.

frequency-response curve A graph showing the frequency response of a radio part, circuit, or system.

frequency run A series of tests made to determine the frequency-response characteristic of a transmission line, circuit, or device.

frequency separator In a television receiver, the stage or circuit that separates the horizontal synchronizing impulses from the vertical synchronizing impulses.

frequency shift A change in the frequency of a radio transmitter or oscillator.

frequency-shift transmission A system of automatic code transmission and reception that shifts the carrier frequency back and forth between two distinct frequencies to designate mark and space, instead of keying the carrier on and off. It provides the advantages of frequency modulation over amplitude modulation for telegraph, teletype, facsimile, and radiophotograph signals without the usual increase in bandwidth.

FREQUENCY STABILITY

frequency stability 1. The ability of a radio transmitter to maintain its assigned carrier frequency. Usually expressed as a percentage deviation from the assigned frequency value. 2. The ability of an oscillator to maintain the output frequency to which it is initially adjusted.

frequency standard A stable low-frequency oscillator used for frequency calibration. It usually generates a fundamental frequency of 50 or 100 kilocycles with a high degree of accuracy, and harmonics of this fundamental are used to provide reference points for checking, 50 or 100 kilocycles apart, throughout the radio spectrum.

frequency swing In frequency modulation, the instantaneous departure of the carrier frequency from the center frequency, resulting in modulation.

frequency tolerance In a radio transmitter, the extent to which the frequency of the transmitter may be permitted to vary above or below the assigned carrier frequency.

frequency tripler A vacuum-tube stage having a resonant plate circuit that is tuned to the third harmonic of the input frequency. The output signal has three times the frequency of the input signal. Used in radio transmitters when it is undesirable or impossible to operate a crystal oscillator or master oscillator at the final high frequency required.

frequency-type telemeter A telemeter that employs frequency as the translating means.

frequency-wavelength relation For radio waves, the frequency in cycles is approximately equal to 300,000,000 divided by the wavelength in meters. The wavelength in meters is approximately equal to 300,000,000 divided by frequency in cycles, or to 300 divided by frequency in megacycles.

fresnel A little-used unit of frequency, equal to 10^{12} cycles per second.

Fresnel lens A thin lens constructed to have the optical properties of a much thicker lens.



Cross-section view of Fresnel lens.

Fresnel's equation An expression for the loss of light at a junction of two transparent media, as at a glass-air junction.

frictional loss Loss of energy due to friction between moving parts.

friction tape Cotton tape impregnated with a sticky moisture-repellent compound. It is used chiefly to hold rubber-tape insulation in position over a joint or splice. Friction tape itself has relatively poor insulating qualities.

fringe effect The extension of the electrostatic field of an air capacitor outside the space between its plates.

fringe howl A squeal or howl heard when some circuit in a receiver is on the verge of oscillation.

Frolich equation An empirical (experimentally produced) formula for magnetic induction B in terms of magnetic intensity H , in which a and b are constants: $B = H/a + bH$. It is approximately valid as saturation is approached.

front-to-back ratio The ratio of the effectiveness of a directional antenna toward the front and toward the rear.

ft Abbreviation for foot or feet.

ft-c Abbreviation for foot-candle.

ft-L Abbreviation for foot-Lambert.

ft-lb Abbreviation for foot-pound.

full-duplex operation Simultaneous operation of a telegraph system in opposite directions.

full load The greatest load that a machine or piece of equipment is designed to carry under specified conditions. Any additional load is an overload.

full-wave rectification Rectification in which both halves of each alternating-current cycle are transmitted as unidirectional current.

full-wave rectifier A double-element rectifier that allows unidirectional current to pass to the load circuit during each half-cycle of the alternating-current supply; one element functions during positive half-cycles and the other during negative half-cycles.



Full-wave rectifier tube.

fundamental The lowest frequency component of a complex vibration, sound, tone, or electrical signal.

fundamental frequency The lowest component frequency of a periodic (oscillating or recurring) wave or quantity. Mathematically, it is the greatest common divisor of the component frequencies.

fundamental harmonic That component of a periodic quantity which has the lowest frequency.

fundamental units Those units which are selected to serve as the basis of an absolute system of units. They are of necessity arbitrarily chosen.

fundamental wavelength The wavelength corresponding to the fundamental frequency. In an antenna, the fundamental wavelength corresponds to the lowest resonant frequency of the antenna alone, without added inductance or capacitance.

fuse A protective device containing a short length of special wire that melts or breaks when the current through it exceeds the rated value for a definite period of time. A fuse is always inserted in series with a circuit so that it



Fused connector.

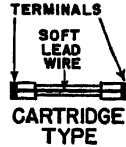

Fuses.

opens the circuit automatically during a serious overload and thereby prevents damage to parts in the circuit.

fuse block An insulating base on which are mounted fuse clips or other contacts for holding fuses.

fuse clip A spring contact for holding a cartridge fuse in position and providing a connection.

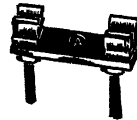

Fuse mountings.

fused quartz A glasslike insulating material having exceptionally good insulating, heat-resisting, and acid-resisting properties. It is made in a transparent form (even clearer than glass) by melting crushed crystals of natural quartz, and is made in a translucent form (cloudy due to millions of tiny bubbles) by melting a certain type of quartz sand.

fuse link That part of a fuse which carries the current of the circuit, and part or all of which melts when the current exceeds a predetermined value.

fuse wire Wire made from an alloy that melts at a relatively low temperature.

G

G Designation for a generator or the grid of a tube.

G Letter symbol for conductance.

g Abbreviation for gram.

G_m Designation for the mutual conductance of a vacuum tube.

gage 1. An instrument for measuring the state of a phenomenon, as a wind gage, oil gage, steam gage, etc. 2. A device for determining whether a specified dimension is within specified limits. An alternate spelling is gauge.

gain The ratio of output voltage, current, or power in an amplifier stage or system to the input voltage, current, or power respectively; usually expressed in decibels. Increasing the gain means increasing output signal strength and increasing the volume of sound produced by the loudspeaker.

gain control 1. A volume control so connected that it can be made to change the over-all gain of an amplifier. 2. Any volume control.

gain of an antenna A rating used in comparing one transmitting or receiving antenna with another. It is the ratio of the signal power one antenna produces at the receiver input terminals to that produced by the other, with the transmitted power level remaining fixed.

galena A crystalline form of lead sulphide, a bluish gray mineral, often used as the crystal in a crystal detector.

galvanic A term used at one time for electricity flowing as a current resulting from chemical action, to distinguish it from electrostatic phenomena. The term comes from the name of L. Galvani of Bologna (1737-1798).

galvanic cell An electrolytic cell that is capable of producing electric energy by electrochemical action.

galvanic current A steady unidirectional current, such as ordinary direct current. Used in electrobiology.

galvanism The therapeutic use of direct current.

galvanometer An instrument for measuring or indicating a small electric current or some function of the current by means of mechanical motion resulting from electromagnetic forces set up by the current. Its scale usually indicates relative deflection, and the actual current value must be calculated. One type consists essentially of a coil of wire suspended in a permanent magnetic field in such a way that it is free to rotate. Used in electrical recorders, in the variable-area type of sound-on-film recorder, and for measuring purposes in laboratories.

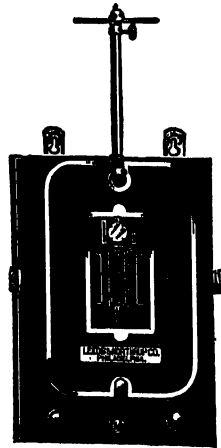

Mirror galvanometer, designed for wall mounting.

galvanometer constant The number by which a certain function of the reading of a galvanometer must be multiplied to obtain the current value in ordinary units.

galvanometer shunt A resistor connected in parallel with a galvanometer

to reduce its sensitivity under certain conditions. It allows only a known fraction of the current to pass through the galvanometer.

galvanotaxis The tendency of a plant or other living organism to move or arrange itself in a medium so that its axis bears a certain relation to the direction of the electric current in the medium.

galvanotropism The tendency of a plant or other organism to grow, turn, or move in a certain relation with an electric current.

gamma 1. A unit of magnetic intensity, equal to 10^{-5} oersted, used in connection with very weak magnetic fields such as those superposed on the earth's magnetic field by local or transient causes. 2. A definite numerical indication of the degree of contrast in a photograph, facsimile reproduction, or received television picture.

gamma ray A type of ray emitted by certain radioactive substances, having a shorter wavelength than X rays but similarly used in the treatment of cancer. Gamma-ray wavelengths are of the order of 10^{-8} millimeter and are thought to be of nuclear origin. Gamma rays are not deflected by a magnetic field. They are the most penetrating of the three principal types of rays given off by radioactive bodies, and are more penetrating than X rays.

gang capacitor Two or more variable capacitors coupled mechanically so they can be adjusted simultaneously by a single control.

gang control Control of a number of similar pieces of apparatus simultaneously with one adjusting knob or device.

gang switch A number of switches mechanically coupled for simultaneous operation but connected to different circuits. In one common form, two or more rotary switches are mounted on the same shaft for operation by a single control.

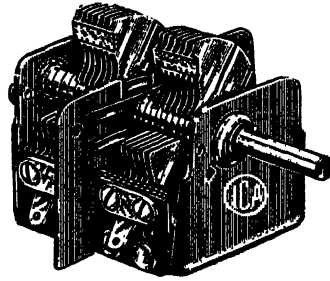

Gang tuning capacitor.

gang tuning capacitor Two or more variable tuning capacitors mounted on the same shaft and connected into successive amplifier stages so that all stages can be tuned simultaneously by a single control. A trimmer capacitor is usually connected in series or in parallel with each capacitor section to permit fine adjustment in order that all sections will be as accurate as if individually controlled.

gap That portion of a magnetic circuit which does not contain ferromagnetic material, such as an air gap.

gap arrester A type of lightning arrester in which there are a number of air gaps in series between cylinders or cones of a metal, such as zinc, which is not liable to arcing.

gas amplification factor In a phototube, the factor of increase in the sensitivity of the tube due solely to the ionization of the contained gas.

gas current Current flowing to an electrode and composed entirely of positive ions produced as a result of gas ionization by an electron current flowing between other electrodes.

gas detector An instrument that detects the presence of inflammable or other gases and operates relays or gives other warning. In one type, a heated filament in a porous vessel burns up any inflammable gas that enters, causing a reduction in pressure that actuates contacts on a diaphragm.

gas-electric drive A power-conversion system in which a gasoline engine drives an electric generator that in

GASEOUS CONDUCTION

turn supplies power to electric driving motors.

gaseous conduction The flow of electricity through a gas due to ionization of the gas by collision of electrons with gas molecules. The electrons are set in motion by a suitably high voltage applied between electrodes in the gas.

gaseous rectifier A gas-filled electron-tube rectifier.

gaseous tube A gas tube.

gas-filled cable A telephone or power cable containing gas under pressure for insulating purposes and to keep out moisture.

gas-filled lamp A tungsten-filament lamp containing nitrogen or an inert gas such as argon; the gas is at about atmospheric pressure when the lamp is hot. The gas prevents disintegration of the filament and consequent blackening of the inside of the bulb.

gas-filled thyratron A thyratron tube having no mercury, being filled instead with xenon (as in the type 2D21) or some other gas. It may be mounted in any position, with no restriction on motion while in operation.

gas-filled tube rectifier A rectifier in which rectification is accompanied by the ionization caused by a unidirectional flow of electrons from a heated electrode within an enclosed space containing an inert gas.

gas focusing Focusing of the electron beam in a cathode-ray tube by varying the filament voltage and temperature, thereby changing the radial electrostatic focusing field that is automatically produced by accumulations of positive ions in the tube. Also called *ionic focusing*.

gas magnification The ratio of increase in current through a phototube due to ionization of the gas in the tube.

gas phototube A phototube into which a quantity of gas has been introduced after evacuation, usually for the purpose of increasing its sensitivity. In a vacuum phototube, no appreciable gas is present.

gassing 1. The evolution of gases from one or more of the electrodes during electrolysis. 2. Liberal production of gas in a storage battery when the charging current is continued after the battery is completely charged.

gassy tube A vacuum tube containing sufficient gas to affect its electrical performance, sometimes permitting effective use as a detector but not as an amplifier.

gas tube An electron tube in which the pressure of the contained gas or vapor is such as to affect substantially the electrical characteristics of the tube. Ionization of the gas molecules gives greatly increased current flow.

gas X-ray tube An X-ray tube in which the emission of electrons from the cathode is produced by positive ion bombardment.

gating The application of a voltage to the cathode or grid of a cathode-ray tube to sensitize it only during the sweep time. In a television receiver this is done by the blanking pulse.

gauge Alternate spelling of gage.

gauss The centimeter-gram-second electromagnetic unit of magnetic induction. It is based on the equation $E = Blv$, in which E is electromotive force in abvolts induced in a conductor of length l centimeters moving with a velocity of v centimeters per second through a magnetic field having a magnetic induction B in gaussess; the three factors are mutually perpendicular. This name was established by the International Electrotechnical Commission in 1930. Before that time, the gauss was the centimeter-gram-second electromagnetic unit of magnetic intensity.

Gauss's theorem The integral over any closed surface of the normal component of the electrical displacement is equal to the electric charge within the surface.

Geiger-Muller counter A counting tube consisting of a metallic cylindrical sheath having a slender wire running axially through its center. Used for

detecting and counting ionized particles in the air. Also called *Geiger counter*.

Geissler discharge The broken-up luminous discharge seen in a Geissler tube when the gas pressure is below about 0.01 atmosphere.

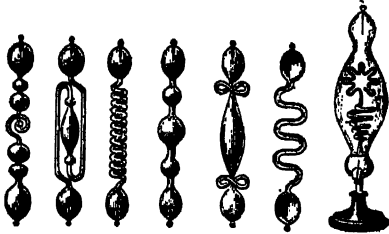

Geissler tubes made in a variety of designs with various types of glass to show the effect of design and glass on illumination.

Geissler tube Any two-electrode discharge tube giving a luminous glow at low pressures. The electrodes are at opposite ends of the tube. The Geissler tube is the early laboratory version of modern neon signs.

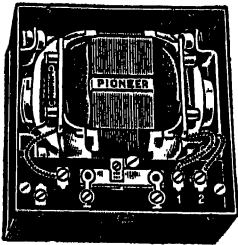

Genomotor.

genemotor A refinement of the dynamotor, consisting essentially of a double-armature high-voltage direct-current generator in which the additional winding operates as a driving motor from a 6-, 12-, or 32-volt battery. It may deliver direct voltages ranging from 300 to over 1,000 volts, depending upon size. Designed especially for automobile receivers and transmitters, sound trucks, and similar mobile applications. Normal efficiency is about 50 per cent, and voltage regulation is comparable to that of alternating-current power packs.

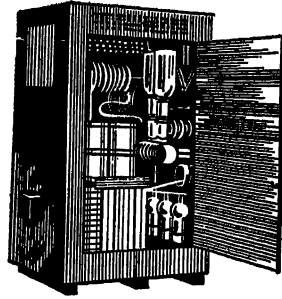

Electronic generator for high-frequency heating.

generator 1. A machine that changes mechanical energy into electrical energy. 2. A rotating machine consisting essentially of a large number of conductors mounted on an armature that is rotated in a magnetic field produced by field coils. In a series generator, the armature, field, and load are all in series. In a shunt generator, the armature, field, and load are all in parallel. In a compound generator, there are two fields, one in series with the armature and the other in parallel with the armature. 3. A vacuum-tube oscillator or any other nonrotating device that generates an alternating voltage at a desired frequency when energized with direct-current or low-frequency alternating-current power. The oscillators used to produce large amounts of radio-frequency power for high-frequency

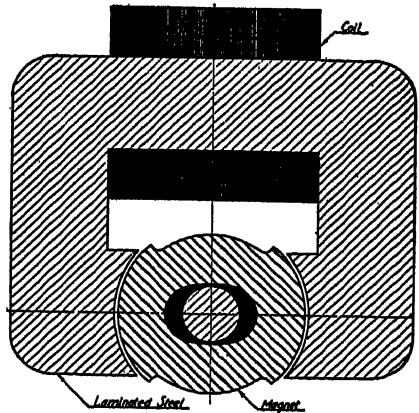

Alternating-current generator using a single high-strength permanent magnet as the rotor.

GEOELECTRIC METHODS

heating purposes are commonly called generators. 4. In wave-guide work, an arrangement of an oscillator, a resonating cavity, and a launching device that together serve to introduce a desired wave into a guide. The oscillator may be either inside or outside the cavity. The generator may employ a Barkhausen oscillator, a special built-in triode with feedback, a magnetron, or a velocity-modulated tube such as a klystron.

geoelectric methods Investigation of the properties of the crust of the earth by observing the distribution of electric potential of the magnetic field in the earth.

geomagnetic surveying Determination of the position of mineral deposits in the earth by means of magnetic measurements.

geometric mean The square root of the product of two quantities.

geophysics That branch of science which deals with factors affecting the structure of the earth. Thus geophysical prospecting utilizes knowledge of the earth's structure as a guide for locating oil deposits.

Georgi units Units in the meter-kilogram-second electromagnetic system of units, based on the meter, kilogram, and second as fundamental units.

German silver A silver-white alloy consisting essentially of copper, zinc, and nickel. Now usually called *nickel silver*.

getter A volatile metal like magnesium, vaporized inside a vacuum tube and allowed to deposit on the glass walls to remove traces of gas remaining after evacuation. The silvery film on the inside of the glass bulb of a vacuum tube, usually near the base, is due to vaporization of the getter.

ghost image In television, an undesired duplicate image offset a short distance toward the right from the desired image. It is due to reception of a reflected signal traveling over a longer path and hence arriving slightly later

than the desired signal. It is eliminated by using a directional receiving antenna adjusted to receive signals over only one path.

gilbert The unit of magnetomotive force in the centimeter-gram-second electromagnetic system. The value of the magnetomotive force in gilberts in any magnetic circuit is equal to the line integral around the circuit of the magnetic intensity in oersteds, with length being in centimeters. One gilbert is equivalent to 0.7956 ampere-turn.

gilberts per centimeter The practical centimeter-gram-second unit of magnetic intensity. It corresponds to volts per centimeter for electric potential gradient. Gilberts per centimeter are the same as oersteds.

Gill-Morrel oscillator A form of Barkhausen oscillator, with its frequency controlled externally to the tube.

Giorgi system The meter-kilogram-second electromagnetic system of units, named in honor of its original proponent.

glass-plate capacitor A high-voltage capacitor in which the metal plates are separated by sheets of glass serving as the dielectric, with the complete assembly generally immersed in oil.

glass-type tube A vacuum tube having a glass envelope or bulb.

glide-path localizer That part of an instrument-landing system for aircraft that provides an indication of altitude to the pilot coming in to a landing without benefit of visual contact with the ground. The official CAA instrument-landing system utilizes an equisignal glide path produced by a transmitter operating at about 300 megacycles and producing a radiation pattern that acts with the runway localizer pattern to create in space a recognizable glide path for a blind landing.



Glass-type tube.

glossmeter An instrument, often photoelectric, for measuring the ratio of the light reflected from a surface in a definite direction to the total light reflected in all directions.

glow discharge A silent luminous discharge of electricity through a gas, without sparks. In a phototube, a glow discharge indicates excessive ionization and excessive current.

glow-discharge tube A vacuum tube in which conduction is chiefly by ions moving in a glow discharge between electrodes.

glow-discharge microphone A microphone in which the action of sound waves on the current forming a glow discharge between two electrodes causes corresponding variations in the current.

glow-discharge voltage regulator A gas tube that varies in resistance between about 5,000 and 30,000 ohms, depending on the value of the applied voltage. It is used to maintain the supply voltage constant for critical tubes in radio equipment, such as for oscillator tubes or for amplifier tubes in measuring instruments.

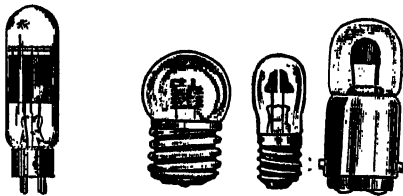

Glow lamp used in early mechanical television systems (left) and modern glow lamps (right).

glow lamp 1. A lamp in which light is produced by a glow discharge between two electrodes in an evacuated envelope into which a small quantity of gas or vapor has been introduced. It does not provide rectification. Neon tubing and mercury-vapor lamps are examples. Neon gives a reddish-orange glow, mercury vapor gives a blue glow, and argon gives a purple glow. 2. A gas-discharge tube serving as a concentrated source of light whose brightness varies in proportion to current flow. When an audio-fre-

quency signal is combined with the lamp current, the brightness of the glow discharge varies in accordance with the audio-frequency signal variations. Used in variable-density sound-on-film recording and in mechanical television systems.

glow potential The voltage at which a glow discharge begins in a gas-filled electronic tube as the voltage is gradually increased.

glow switch A small gas-discharge tube consisting of a pair of contacts, one actuated by a bimetallic strip, in a glass bulb containing a rare gas such as neon or argon. The tube and an inductance are connected in series with a fluorescent lamp for starting purposes. In starting, a glow discharge heats the thermostatic strip and bends it to close the switch contacts. These apply filament current to the fluorescent lamp. The thermostatic strip cools quickly, its contacts open, and the resulting inductive surge strikes the arc in the lamp. If the arc does not strike the first time, the contacts quickly open and close again automatically until it does start.

glow tube A cold-cathode gas-discharge tube in which no means is provided for controlling the unidirectional current flow. Examples are the BH rectifier tube and the more modern OZ4 cold-cathode gaseous rectifier.

GMT Abbreviation for Greenwich Mean Time.

gnd Abbreviation for ground.

goniomic projection A method of geometric projection of the surface of a sphere onto a plane touching the sphere, by means of radials from the center of the sphere. Used in the interpretation of X-ray diffraction patterns of crystals. Also used for the construction of certain navigational charts.

gobo 1. A black or dark sheet of wallboard or similar material used to shield the lens of a television camera from near-by lights. 2. A sheet of

GOLD

sound-absorbing material used to shield a microphone from sounds arriving in a certain direction.

gold A precious metal used in some delicate electric instruments, as in the gold-leaf electroscope. Also used for electroplating radio parts that must withstand severe corrosive conditions such as exist in the tropics.

gold-leaf electroscope An apparatus in which two pieces of gold leaf are joined at their upper ends and suspended inside an insulating support such as a glass jar. The leaves spread out owing to repulsion of like charges when a charge is applied to the terminal connected to the leaves.

Goldschmidt alternator A rotating machine employing oscillating circuits in connection with both the field and the armature to introduce harmonics of the fundamental generated frequency. Interaction between stator and rotor harmonics gives a cumulative effect, providing very high radio frequencies. Used as a transmitter in the early days of radio.

goniometer An instrument for measuring angles. In radio, it takes the form of a directional antenna system and associated apparatus used for determining the direction or angle at which signals are arriving from a radio transmitting station. In another form, it is used in connection with an X-ray tube to measure the angular positions of the different axes in quartz crystals.

gradation The scale of tonal values in a reproduced image or photograph.

gradient The rate at which a variable quantity increases or decreases. Thus, potential gradient is the difference of potential per unit length along a conductor or through a dielectric.

gram A metric unit of mass, originally defined as the mass of one cubic centimeter of pure water at 4° centigrade. One gram is equal to one-thousandth of a kilogram. There are about 28.4 grams in 1 ounce.

gram atom That mass of an element which, in grams, is numerically equal to the atomic mass of the element. A gram atom of any element thus contains the same number of atoms (about 6.06×10^{23} atoms, which is Avogadro's number).

Gramme ring An armature constructed in the form of a ring of iron around which the coils are wound. Each turn is tapped at the small diameter of the ring and connected to a commutator segment. Introduced by Z. T. Gramme in 1870 for motors and generators.

gram molecule That mass of a pure substance which, in grams, is numerically equal to the molecular mass of the substance. The gram molecule of every pure substance thus contains the same number of molecules (about 6.06×10^{23} molecules, which is Avogadro's number). Also called *mol* or *mole*.

granular carbon Small particles of carbon, used in carbon microphones.

graph A pictorial presentation of the relation between two or more variable quantities, such as between an applied voltage and the current it produces in a circuit.

graphical analysis The use of diagrams and graphical methods to obtain operating data and answers to scientific and mathematical problems.

graphical integration The use of graphical methods to obtain the average value, over a chosen period of time, of a varying quantity such as voltage or current.

graphic instrument Any instrument that makes a continuous record of its indications on a traveling paper chart by means of a pen or other marking device attached to its moving system.

graphite A finely divided form of carbon, used as a lubricant and sometimes also in the construction of carbon resistance elements.

grass A pattern resembling blades of grass, superimposed on a cathode-

ray tube trace due to noise picked up by the radio receiver feeding the cathode-ray tube.

grating A device for spreading out light or other radiation by interference between waves emerging from fine parallel slits in a plate or from narrow parallel reflecting surfaces made by ruling grooves on polished metal. Often called *diffraction grating*.

grating constant The distance between adjacent rulings on a diffraction grating.

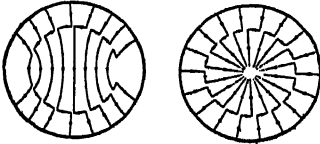

Typical double gratings of grating converters used in wave guides. That at the left converts $H_{1,1}$ waves to $H_{0,1}$ waves and vice versa, while that at the right serves similarly for $E_{0,1}$ and $H_{0,1}$ waves.

grating converter A wave converter consisting of a double grating positioned just ahead of a coaxial sheet grating in a circular wave guide. The double grating is essentially the result of superimposing one wire grating on another, with one grating conforming to the pattern of the arriving wave and the other to the pattern of the converted wave.

Grätz rectifier An arrangement of four electrolytic rectifiers per phase, connected into bridge circuits for full-wave rectification.

gravity cell A primary cell in which two electrolytes are kept separate by their difference in specific gravity. It is a modification of the Daniell cell, and is now obsolete.

grease-spot photometer A photometer employing a spot of grease on a screen. The spot appears to vanish when both sides of the screen are equally illuminated. Also called *Bunsen photometer*.

Grenz rays X rays produced at the long-wavelength end of the X-ray spectrum, involving wavelengths of the order of 1 to 10 angstroms. The

tubes for producing these rays operate at relatively low voltages, from 5,000 to 15,000 volts, and must have special windows of a material such as Lindemann glass through which the X rays can pass, since they are absorbed by ordinary glasses. These rays are used in superficial skin therapy and to some extent in extremely low-voltage radiography of flowers, insects, botanical specimens, etc.

grid 1. An electrode having one or more openings for the passage of electrons or ions. It generally consists of a wire spiral or mesh positioned between the cathode and anode of an electron tube, and controls the flow of electrons from cathode to anode. **2.** The metallic framework (usually lead) of the electrodes or plates of a storage battery. **3.** A network of high-voltage transmission lines interconnecting several power stations.

grid bias The direct voltage used to make the control grid of a vacuum tube negative with respect to the cathode and provide the desired operating point. Also called *C bias*.

grid-bias cell A bias cell used in the grid circuit of a vacuum tube to make the grid negative with respect to the cathode. It provides a voltage but cannot supply appreciable current.

grid capacitor A small capacitor, usually mica, used in the grid circuit of a vacuum tube.

grid-cathode capacitance The direct capacitance between the grid and the cathode in a vacuum tube. Designated C_{gk} .

grid characteristic The curve obtained by plotting grid-voltage values of a vacuum tube as abscissas against grid-current values as ordinates on a graph.

grid circuit The circuit connected between the grid and cathode of a vacuum tube, forming the input circuit of the tube.

grid clip A spring clip used to make a connection to the top cap terminal on some vacuum tubes.

GRID CONDUCTANCE



Grid clips.

grid conductance The inphase component of the alternating grid current divided by the alternating grid voltage, all other electrode voltages being maintained constant.

grid-controlled rectifier A triode mercury-vapor rectifier tube in which the grid determines the instant during each cycle when plate current starts to flow, but does not determine how much current will flow.

grid-control tube A mercury-vapor-filled thermionic vacuum tube having an external grid control.

grid current The current passing to or from a grid through space inside a vacuum tube.

grid detection Detection taking place due to the action of the grid circuit of a vacuum tube, as in a grid-leak capacitor detector.

grid-dip oscillator A vacuum-tube oscillator having in its grid circuit a sensitive current-indicating meter that dips (reads lower grid current) when energy is drawn from the oscillator, as by a coupled resonant circuit tuned to the oscillator frequency.

grid driving power The average product of the grid current and the alternating component of grid voltage over a complete cycle. This includes both grid dissipation and power supply to the biasing device.

grid emission Electron or ion emission from a grid in a vacuum tube.

grid-glow tube A cold-cathode gas-discharge tube in which one or more electrodes are employed to control electrostatically (with grids) the starting of the unidirectional current flow. During operation, there is a luminous glow near the electrodes due to ionization of the gas.

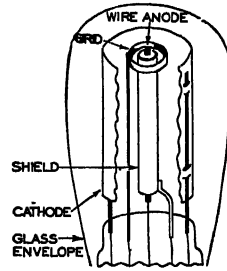

Construction of grid-glow tube.

grid leak A resistor used in the grid circuit of a vacuum tube to provide a discharge path for the grid coupling capacitor. The value of the resistor determines the average value of the developed grid bias.

grid-leak capacitor detector A type of detector circuit in which audio-frequency voltage developed across a grid resistor by the flow of modulated radio-frequency grid current through that resistor causes corresponding audio-frequency plate-current changes. The circuit provides square-law detection with high sensitivity on weak signals and linear detection on strong signals. Identified by a grid leak (grid resistor) and grid capacitor in the grid circuit.

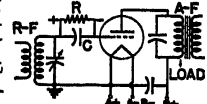

Grid-leak capacitor-detector circuit.

grid limiting Limiting the positive grid voltage of a vacuum-tube circuit by means of a high-resistance grid resistor.

grid modulation Modulation produced by introduction of the modulating wave into any of the grid circuits of any tube in which the carrier-frequency wave is present.

grid-plate capacitance The direct capacitance between the grid and the plate in a vacuum tube. Designated C_{gp} .

grid-plate transconductance Mutual conductance, which is the ratio of plate-current changes to grid-voltage changes.

GROUND DIELECTRIC CONSTANT

grid-pool tank A grid-pool tube having a heavy metal envelope somewhat resembling a tank in appearance.

grid-pool tube A gas-discharge tube with a pool-type cathode (liquid or solid) in which one or more electrodes are provided for controlling electrostatically the starting of the unidirectional current flow. Sometimes called a grid-pool tank when it has a metal envelope.

grid return That portion of a grid circuit which completes the electrical path from the grid to the cathode.

grid suppressor A resistor connected between the control grid and the tuned portion of the grid circuit of a radio-frequency amplifier to prevent parasitic oscillation due to feedback through the grid-plate capacitance.

grid swing The total variation in grid-cathode voltage, from the positive peak to the negative peak of the applied signal voltage. The grid swing is thus equal to twice the peak value of the applied signal voltage.

grid voltage The voltage between a grid and the cathode.

grid-voltage supply The means for supplying a potential to the grid of a thermionic vacuum tube with proper regulation. It usually causes the grid to be negative with respect to the cathode.

grille An ornamental arrangement of wood, metal, or plastic bars placed across the front of a loudspeaker in a cabinet.

grille cloth A loosely woven cloth stretched across the front of a loudspeaker in a radio receiver cabinet to keep dust out of the loudspeaker and improve the appearance. Sound waves are not appreciably impeded by the cloth.

grommet An insulating washer, usually made of rubber or a plastic material, inserted in a chassis or panel hole to prevent a wire from touching the sides of the chassis or panel through which it must pass.

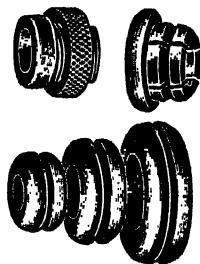

Grommets.

groove The track cut in a phonograph record or other medium by the stylus during sound recording, or the track in which a phonograph needle rides during playback.

ground 1. A conducting connection, intentional or accidental, between an electric circuit or equipment and the earth or some conducting body serving in place of the earth. 2. The chassis of a receiver when it is connected to ground or is at zero radio-frequency potential with respect to ground.

ground absorption Loss of power occurring during the transmission of radio waves due to dissipation in the ground.

ground-air radio frequency A frequency specified or agreed upon for transmissions from an aircraft station to an aeronautical ground station. Transmissions in the opposite direction use an air-ground radio frequency.



Ground clamp.

ground clamp A clamp used for connecting a grounding conductor (ground wire) to a grounded object such as a water pipe or a metal stake driven into the ground.

ground current Any current flowing in the earth.

ground dielectric constant The dielectric constant of the earth at a given location.

GROUNDED

grounded Connected to earth or to some conducting body that serves in place of the earth. The British term is earthed.

grounded circuit A circuit in which one conductor or point, usually the middle wire or neutral point of transformer or generator connections, is intentionally grounded either solidly or through a current-limiting device.

grounded parts Those parts which are so connected that they are substantially at the same potential as the earth when the installation is complete.

grounded shunt-excited vertical radiator A vertical transmitting antenna having its lower end grounded directly, with the transmission line terminated on the antenna a short distance above ground.

ground equalizer inductors Coils having relatively low inductance, inserted in the ground circuit going to one or more of the grounding points of an antenna to distribute the current to the various points in any desired manner.

ground glass A pane of glass that has been roughened by grinding with emery powder or by sandblasting, used for making camera focusing screens and for diffusing lights.

ground outlet An outlet equipped with a receptacle of the polarity type (permitting insertion of a plug in one position only) and having in addition a grounded contact to which the grounding conductor of a portable electric appliance may be connected.

ground plane antenna A vertical antenna combined with a turnstile element to lower the angle of radiation, and having a concentric base support and center conductor that together serve to place the antenna at ground potential even though it may be located several wavelengths above-ground. The arrangement also provides exact impedance matching to coaxial transmission lines commercially available, so that the entire antenna acts as a pure resistance at the operating frequency.

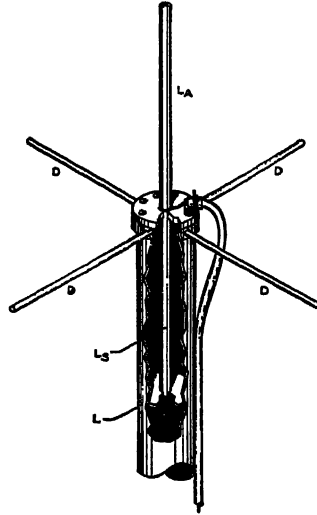

Ground plane antenna, formed by the addition of turnstile element *D* to a high-frequency vertical antenna *LA* having a metallic support *L* and a center conductor *LS* acting as an inductance, with the combination being fed by a coaxial transmission line running outside the support.

ground potential Zero potential with respect to the ground or earth.

ground-reflected wave The component of the ground wave that is reflected from the ground.

ground resistance A value expressing the resistance offered to radio waves in traveling from the transmitting antenna through the ground system into the earth. It varies considerably with the nature of the surrounding soil.

ground-return circuit A circuit that is completed by utilizing the earth as a conductive path.

ground system That portion of an antenna system connected below the loading or coupling devices, closely associated with the ground and including the ground itself.

ground wave A radio wave that is propagated over the surface of the earth and is ordinarily affected by the presence of the ground. The ground wave includes all components of a radio wave except the ionospheric and tropospheric waves.

ground wire A conductor leading from radio equipment to an electrical connection with the ground. An elaborate system of outward-radiating buried ground wires is generally used with large transmitting antennas to provide a low-resistance path to ground.

group velocity 1. The velocity at which a signal travels through a wave guide. Group velocity is always less than the velocity of a signal in open air, because signals follow zigzag paths through wave guides, while phase velocity is merely an illusion. 2. The velocity of propagation of the envelope of a wave occupying a frequency band over which the envelope delay is uniform. It differs from phase velocity in a medium in which the phase velocity varies with frequency or direction.

Grove cell A primary cell having a platinum electrode in an electrolyte of nitric acid within a porous cup, outside of which is a zinc electrode in an electrolyte of sulphuric acid. This cell normally operates on a closed circuit.

growler An electromagnetic device consisting essentially of two field poles arranged as in a motor, used for locating short-circuited coils and for magnetizing or demagnetizing objects. A growling noise indicates a short-circuited coil.

guard band A narrow band provided between adjacent channels in certain portions of the radio spectrum to prevent interference between stations. In television, a 0.25-megacycle guard band is provided at the high-frequency end of each television channel for this purpose.

guard ring A ring-shaped metal structure placed around a charged terminal or object to ensure uniform distribution of the electric field at the edges.

guard wire A grounded wire erected near a low-voltage circuit or public crossing in such a position that a high-voltage overhead conductor cannot make accidental contact with the low-voltage circuit or with persons or objects below without first becoming grounded by contact with the guard wire.

Gudden-Pohl law The number of electrons liberated in the photoconductive action of selenium is equal to the number of radiation quanta absorbed.

guided wave A wave whose propagation is concentrated in certain directions within or near boundaries in a path between two places.

guidon radio set A combination radio transmitter and receiver, part or all of which is mounted directly on a portable antenna mast which can either be pushed into the ground or inserted in a cavalry boot.

gutta-percha A natural vegetable gum similar to rubber, used principally as insulation for wires and cables.

guy anchor The buried weight or mass to which the lower end of a guy wire is attached.

guy wire A wire used to support a pole or tower against overturning. One end is securely anchored to the ground or to some heavy object, and the other end is attached to the upper part of the pole or tower.

gyro frequency The natural frequency of rotation of ions around the lines of the magnetic field of the earth. For electrons, it is of the order of 700 to 1,600 kilocycles, and for ions it is in the audio-frequency range.

gyromagnetic Pertaining to the magnetic properties of rotating electric charges, such as spinning electrons moving within atoms.

H

- H** 1. Chemical symbol for hydrogen.
 2. Heater or filament terminal of a heater-type thermionic vacuum tube.
 3. Letter used on diagrams to designate magnetizing force (also known as magnetic intensity or magnetic force).

H Letter used in equations to designate magnetizing force (also known as magnetic intensity or magnetic force).

- h** Abbreviation for henry, the unit of inductance.

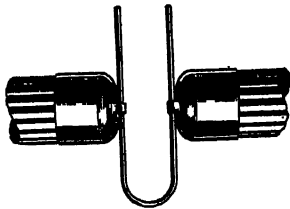

Hairpin tuning bar.

hairpin tuning bar A hairpin-shaped metal bar inserted between the two halves of a doublet antenna. It can be slid in or out to vary the over-all electrical length of the antenna without moving the two halves of the antenna itself.

half cell An electrode immersed in a suitable electrolyte, and designed for measurements of single electrode potentials.

half-duplex operation Operation of a duplex telegraph system in either direction at one time but not in both directions simultaneously.

half-period average value The absolute value of the average of the values of a symmetrical alternating quantity taken through a half period (half cycle), beginning with a zero value.

half-tone characteristic A relation, usually shown by a graph, between the density of the recorded copy and the

density of the subject copy in a facsimile system.

half-value layer See *half-value thickness*.

half-value thickness The thickness of a given substance which, when introduced in the path of a given beam of rays, will reduce its intensity to one-half of the initial value. Also called *half-value layer*.

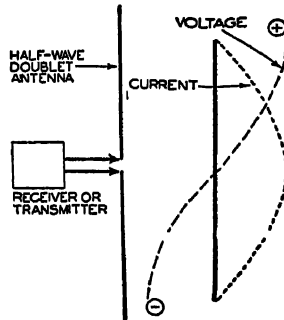

Half-wave antenna with voltage and current characteristics. Note that voltage is zero at the center, and current is zero at the ends.

half-wave antenna An antenna whose length is approximately equal to one-half the wavelength being transmitted or received.

half-wave dipole A straight ungrounded antenna substantially one-half wavelength long. It is usually fed at its center, where the input impedance is about 72 ohms regardless of size or wavelength.

half-wave line A transmission line having an electrical length equal to one-half the wavelength of the signal being transmitted or received.

half-wave plate A plate of mica or other doubly refracting crystal material, of such thickness as to introduce a phase difference of one-half cycle between the ordinary and the extraordinary components of light passing through.

half-wave rectification Rectification permitting only one-half of each alternating-current cycle to be transmitted as unidirectional current.

half-wave rectifier A rectifier that changes alternating current into pulsating current, utilizing one-half of each cycle.

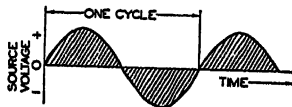
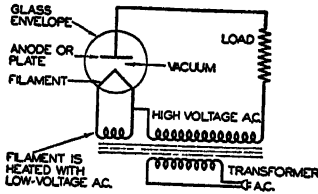

A-C INPUT VOLTAGE

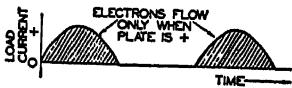

DIRECT VOLTAGE AT LOAD

Half-wave rectifier circuit, with wave forms of alternating-current source voltage and pulsating load current.

half-wave transmission line A transmission line having an electrical length equal to one-half the wavelength of the signal being transmitted or received.

Hall effect The development of a potential difference between the two ends of a strip of metal in which an electric current is flowing longitudinally, when the plane of the strip is perpendicular to a magnetic field.

Hallwachs effect A type of photoelectric effect discovered by Hallwachs in 1888, whereby a negatively charged body in a vacuum can be discharged by irradiating it with ultraviolet light.

ham Slang expression for a person who operates and experiments with transmitters, receivers or other electronic equipment as a hobby and not for profit. Also called *amateur*.

hand capacitance Body capacitance, occurring when the hand is brought near a tuning capacitor or other part in a receiver that is insufficiently shielded, changing the tuning.

hand receiver A telephone receiver (headphone) designed to be held to the ear by the hand.

hand reset Requiring manual resetting. Applied chiefly to relays and circuit breakers.

hangover In facsimile, the excessive prolongation of the decay of the signal-wave tail. Also called *tailing*.

hard brass Brass that has not been annealed after drawing or rolling. Used for springs and other parts requiring flexibility.

hard-drawn copper wire Copper wire that has been drawn to size through several dies, thus becoming hard and having greater tensile strength.

hard magnetic materials Magnetic materials that are not easily demagnetized. Permanent-magnet materials are of this class.

hardness 1. That quality which determines the penetrating ability of X rays. The shorter the wavelength, the harder are the rays and the greater is their penetrating ability. 2. The degree of evacuation (rarefaction of residual gas) in an X-ray tube or other vacuum tube. The harder the tube, the better is its vacuum, the higher is the voltage required to cause a discharge with a cold cathode, and the shorter is the wavelength of the resulting X rays.

hard ray An X ray having high penetrating power.

hard rubber Rubber that has been vulcanized at high temperatures and pressures; used in panels and in other forms for insulation.

hard solder A solder composed principally of copper and zinc, having a high melting point and requiring heating to a red heat for melting. Hard soldering is practically equivalent to brazing.

HARD TUBE

hard tube A vacuum tube that has been evacuated to a high degree, approaching a perfect vacuum. A tube containing appreciable gas is called a soft tube.

harmonic A sinusoidal component of a periodic wave or quantity, having a frequency that is an integral multiple of the fundamental frequency. Thus, a component whose frequency is twice the fundamental frequency is called the second harmonic.

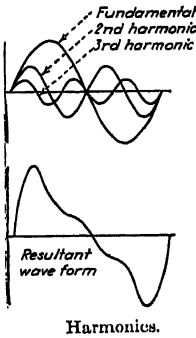

harmonic analysis 1. Any method of identifying and evaluating the harmonics that make up a complex waveform of voltage, current, or some other varying quantity. 2. The expression of a given function as a series of sine and cosine terms that are approximately equal to the given function, such as a Fourier series.

harmonic analyzer An electrical or mechanical apparatus that divides a complex wave into its component pure sine waves. In effect, it measures the strength of each frequency component in a complex signal.

harmonic antenna An antenna whose length is an integral multiple of a half-wavelength. Also called *long-wire antenna*.

harmonic component Any of the components (simple sinusoidal quantities) into which a periodic quantity may be resolved.

harmonic content The degree of distortion in the output signal of an amplifier.

harmonic detector A voltmeter circuit so arranged as to measure only a particular harmonic of the fundamental frequency.

harmonic distortion Waveform distortion, in which the output of a tube

or circuit contains added harmonics of the input frequencies due to improper operation of the circuit.

harmonic filter A combination of inductance and capacitance tuned to an undesired harmonic in a circuit, so as to suppress that harmonic.

harmonic generator A vacuum tube or other generator operated under conditions in which it generates an alternating current having strong harmonics.

harmonic interference Interference between radio stations due to the presence of harmonics of the carrier frequency in the output of one or more of the stations.

harmonic motion Any motion corresponding to that of a simple pendulum. It is equivalent to the projection of uniform circular motion onto any diameter of that circle. A sine wave represents simple harmonic motion.

harmonic wave analyzer An instrument that provides a means for determining the harmonic content at the output of an audio-frequency amplifier or other apparatus.

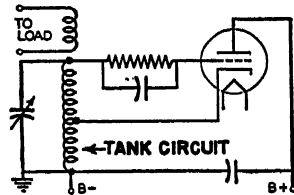

Hartley oscillator circuit.

Hartley oscillator A vacuum-tube oscillator circuit characterized by a tuned circuit having a tapped winding whose outer ends are connected to the grid and plate, respectively, of the vacuum tube, with the tap going to the cathode.

hash Noise signals produced by a vibrator when there is excessive sparking at the contact points.

hatching Marking an area on a diagram with a series of parallel lines to give an effect of shading. When two sets of parallel lines crossing each other are used, the effect is called crosshatching.

Hazeltine licensed Apparatus utilizing Hazeltine patents under a licensing agreement with Hazeltine Corp.

Hazeltine neutralizing circuit An early form of neutralized radio-frequency amplifier circuit.

He Chemical symbol for helium, an inert gas used in place of neon in some electric signs.

head 1. The cutting head in a recorder, serving to produce grooves on a blank record. **2.** That part of a motion-picture projector which converts the sound track on the film into corresponding audio-frequency signals.

head amplifier An audio-frequency amplifier mounted on or close to the sound head of a motion-picture projector to amplify the extremely weak output of the phototube.

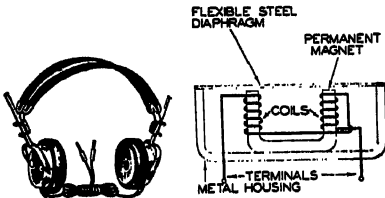

Example and construction of headphones.

headphone A small telephone receiver, used either singly or in pairs for private reception of radio programs or for communication purposes. In the early days of radio, headphones were used for reception of signals too weak to provide loudspeaker volume, but powerful audio-frequency amplifiers in modern receivers have outmoded this use.

headphone adapter A device that slips under the power output tube, or is otherwise connected to a radio receiver, and provides terminals to which headphones can be connected.

head receiver A telephone receiver (headphone) designed to be held to the ear by a headband.

headset A pair of headphones with a connecting clamp designed to support the phones snugly against the ears.

heater An electric heating element for supplying heat to an indirectly heated cathode in an electron tube.

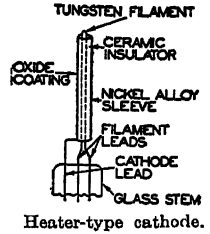

Heater-type cathode.

heater current The current flowing through a heater serving an indirectly heated cathode.

heater voltage The voltage between the terminals of a filament used for supplying heat to an indirectly heated cathode.

heating element A complete wire-wound resistor, including terminals and insulating supports, as used in electric heating devices.

heat of emission The additional heat energy that must be supplied to an electron-emitting surface in order to maintain it at a constant temperature.

heat of radioactivity The heat generated per unit time by radioactive disintegration.

heat run A series of tests made on an electric device to determine the degree of heat generated.

Heaviside bridge An instrument similar to a Wheatstone bridge, used for measuring mutual inductance.

Heaviside-Hertz equations A set of electromagnetic field equations involving dielectric constant, permeability, electric conductivity, magnetic intensity, and electric intensity.

Heaviside layer A region of highly ionized air in the ionosphere, having

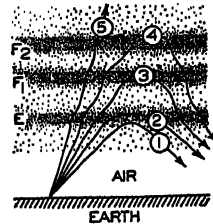

Action of ionosphere in reflecting sky waves back to earth. Five possible paths are shown.

HEAVISIDE-LORENTZ ELECTROMAGNETIC SYSTEM

maximum intensity at about 65 miles above the earth's surface, capable of reflecting or bending radio waves back to earth under certain conditions. It is made up of E_1 and E_2 layers. Also called *Kennelly-Hecviside layer*.

Heaviside-Lorentz electromagnetic system A system of units so devised that the same constants appear in the magnetic laws and in the corresponding electric laws. Frequently used in electromagnetic theory but seldom used in measurements.

Heaviside units A system of electromagnetic units in which some of the units differ from those in the centimeter-gram-second system by the factor 4π in order to simplify calculations.

heavy electron A particle having the same unit negative charge as an electron but a mass intermediate between that of the electron and the proton. Produced by cosmic radiation impinging on gas molecules, or actually forming a part of cosmic rays. Also called *barytron*, *dynatron*, *mesotron*, *penetron*, *X particle*, etc.

heavy hydrogen The hydrogen isotope having an atomic weight or mass of 2, usually called deuterium, or the isotope having an atomic weight or mass of 3, called tritium.

Hefner unit The German unit of light intensity, equal to about 0.9 candle.

height control The control in a television receiver that adjusts picture size in a vertical direction.

Heising modulation A method of modulating a carrier wave in which the plates of both the radio-frequency oscillator and modulator tubes are fed through a common inductor having a high impedance. The inductor prevents any change in total plate current drawn by the two tubes together; hence audio-frequency plate-current variations in the modulator tube produce similar but opposite audio-frequency variations in the plate current of the radio-frequency oscillator tube. Also called *constant-current modulation*.

helical Having the shape of a helix or coil.

helix A space curve resembling a corkscrew. Wire wound on a cylinder produces a helix.

Helmholtz coils Two circular coils of equal size placed end to end at a distance apart equal to their radius, and carrying the same current. The magnetic field between them and near the common axis is practically uniform.

Helmholtz double layer A term applying to a metal in contact with an electrolyte, including the layer of positive metallic ions in the electrolyte next to the metal and the adjacent layer of negative charges in the metal.

Helmholtz pendulum A pendulum device that can be used to charge a capacitor for a desired definite short time or impart varying amounts of magnetism to a specimen of iron.

hemadynamometer An electronic instrument that indicates a balance of blood pressure against a measurable air pressure in testing blood pressure.

henry The centimeter-gram-second electromagnetic unit of inductance or mutual inductance. The inductance of a circuit is one henry when a current variation of one ampere per second induces one volt. The millihenry, equal to one-thousandth of a henry, is a more convenient unit. The plural is henrys.

heptode A seven-electrode vacuum tube containing an anode, a cathode, a control electrode, and four additional electrodes ordinarily in the nature of grids.

hermetically sealed Sealed tightly enough to keep out air and moisture.

hertz A unit of frequency equal to one cycle per second; rarely used in the United States.

Hertz antenna An ungrounded antenna.

Hertz effect The promotion of ionization and a spark discharge under the application of ultraviolet radiation.

HETERODYNE WHISTLE

Hertzian oscillator Two metal plates or other conductors separated by an air gap, forming a capacitor of very small capacitance in which ultrahigh-frequency oscillations can occur.

Hertzian vector A vector pertaining to the electromagnetic field of a radio wave. Both the electric and magnetic intensities can be specified in terms of it. A related term is Poynting's vector.

Hertzian wave An electromagnetic wave produced by oscillations (rapid reversals of current flow) at a radio-frequency rate in a conductor. First demonstrated by Heinrich Hertz in 1888. Now called *radio wave*.

heterodyne Pertaining to the production of a difference frequency (beat) by combining two frequencies. The beat frequency, being lower than the original frequency, is more readily amplified.

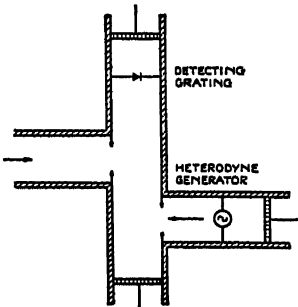

Heterodyne-detector circuit used with tuned resonating cavity at the end of a wave guide for receiving and detecting waves. The crystal detector in the detecting grating feeds the signal in useful form to a sound, television, or other receiver.

heterodyne detector 1. A radio receiver employing the heterodyne system of reception for signals, involving combining of incoming signals with a locally produced signal having a slightly different frequency, to provide an audio-frequency beat signal that can be heard with a loudspeaker or headphones. 2. A combination of a heterodyne generator, a tuned resonating cavity, and a detecting grating used at the end of a wave guide for the purpose of receiving and detecting

waves. The beat frequency is detected by a grating conforming to the pattern of the modulated wave.

heterodyne frequency A beat frequency, which is the sum or difference frequency of two signals.

heterodyne frequency meter A heterodyne wavemeter.

heterodyne oscillator A separate oscillator for producing the local oscillations required to obtain the intermediate-frequency signal in a superheterodyne receiver, or for producing the beat signal in heterodyne detection.

heterodyne reception The process of receiving radio waves by combining a received radio-frequency voltage with a locally generated alternating voltage to produce a beat frequency that is more readily amplified. This is done in a nonlinear circuit element, with the result that in the output there are frequencies equal to the sum and difference of the combining frequencies. If the received waves have constant amplitude and are continuous as in telegraphy, the locally generated frequency can be so chosen that the difference frequency is audible. When the received waves are modulated, the locally generated frequency is generally so chosen that the difference frequency is above audibility (at the intermediate-frequency value) and an additional operation is necessary before the original signal wave is reproduced. Also called *beat reception*.

heterodyne wavemeter A wavemeter employing the heterodyne principle to compare the frequency being measured with a frequency being generated in a calibrated oscillator circuit. Also called *heterodyne frequency meter*.

heterodyne whistle A steady squeal heard in a radio receiver due to a beat formed by heterodyne interference between stations having nearly equal carrier frequencies.

HETEROGENEOUS

heterogeneous Composed of different kinds of parts or materials. Opposite of homogeneous.

hexode A six-electrode vacuum tube, containing an anode, a cathode, a control electrode, and three additional electrodes ordinarily in the nature of grids.

h-f Abbreviation for high-frequency, a Federal Communications Commission designation for the band from 3 to 30 megacycles in the radio spectrum. Same abbreviation used for noun as for adjective.

Hg Chemical symbol for mercury.

Hilbert flux standard A permanent magnet with a ring-shaped air gap through which a coil of wire is dropped to produce a definite change in the magnetic flux linked with the coil.

hickey A fitting used to mount a lighting fixture in an outlet box or on a pipe stud. It has openings through which the fixture wires can be run.

high definition The television or facsimile equivalent of high fidelity, in which the reproduced image is composed of such a large number of accurately reproduced-individual picture elements that extremely fine detail in the picture is clearly visible.

high-fidelity receiver A radio receiver capable of receiving and satisfactorily reproducing modulated carrier waves in which the audio-frequency modulation may range from about 30 cycles to about 15,000 cycles. Such a receiver approaches the goal if the reproduced program cannot be distinguished from the original sound picked up by the microphone.

high frequency A frequency in the band extending from 3 to 30 megacycles in the radio spectrum. Federal Communications Commission designations for the entire radio spectrum are:

vf 10 to 30 kilocycles
l-f 30 to 300 kilocycles
m-f 300 to 3,000 kilocycles
h-f 3 to 30 megacycles

vfh 30 to 300 megacycles
uhf 300 to 3,000 megacycles
shf 3,000 to 30,000 megacycles

high-frequency alternator An alternator capable of generating radio frequencies of sufficiently high value for use as carrier waves in radio communication.

high-frequency broadcast band The band of frequencies originally extending from 43,000 to 50,000 kilocycles, allocated exclusively to frequency-modulation broadcast service.

high-frequency broadcast station A station licensed primarily for the transmission of radiotelephone emissions intended to be received by the general public and operated on a channel in the high-frequency broadcast band, using frequency modulation exclusively.

high-frequency carrier telegraphy That form of carrier telegraphy in which the carrier currents have frequencies above the range transmitted over a voice-frequency telephone channel.

high-frequency furnace An induction furnace in which the heat is generated within the charge, within the walls of the containing crucible, or in both, by currents induced by high-frequency magnetic flux produced by a surrounding coil. Also called *coreless-type induction furnace*.

high-frequency resistance The total resistance offered by a device in an alternating-current circuit, including resistance due to eddy current, hysteresis, dielectric, and corona losses as well as the direct-current resistance. Also called *alternating-current resistance* and *radio-frequency resistance*.

high-frequency treatment The therapeutic use of intermittent and isolated trains of heavily damped oscillations having high frequency, high voltage, and relatively low current.

high-frequency trimmer In a superheterodyne receiver, a trimmer capacitor that controls the calibration of a tuning circuit at the high-frequency end of a tuning range.

high-frequency welding Welding with high-frequency current obtained from an electronic generator of the type used for electronic heating or from a special electronic circuit employing externally controlled two-element mercury-vapor discharge tubes. Welding time can be controlled more accurately than at power-line frequencies, permitting successful welding of silver to steel, magnesium to cast iron, thin sheets to heavy structural members with airtight joints, and other difficult-to-weld combinations. High-frequency currents are also being used in conjunction with conventional torches for welding glass pieces together.

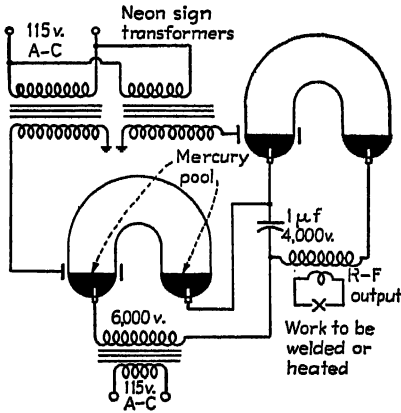

Electronic circuit used for one form of high-frequency welding.

high-level modulation Modulation produced in the last radio stage, or at a point in a system where the power level approximates that at the output of the system.

highlight The brightest part of a reproduced image.

high- μ tube A vacuum tube having a high amplification factor.

high-pass filter A filter designed to pass currents at all frequencies above a critical or cutoff frequency, while substantially reducing the amplitudes of currents at all frequencies below this critical frequency.

high-pressure mercury-vapor lamp An extremely small tubular bulb con-

taining an inert gas at a moderate pressure and a small quantity of liquid mercury. The initial glow discharge through the gas heats and vaporizes the mercury, after which the discharge is through mercury vapor and an intensely brilliant light is produced. The main bulb is surrounded by an outer bulb containing gas at a low pressure, to maintain the mercury vapor in the inner tube at the necessarily high working temperature. Used for illumination and for irradiation purposes.

high Q Having a high ratio of reactance to effective resistance, and hence having a high Q factor.

high-resistance voltmeter A voltmeter having a resistance considerably higher than 1,000 ohms per volt, so that it draws very little current from the circuit in which a measurement is made.

high-speed telegraph transmission Transmission of code at speeds higher than are possible with hand-operated keys.

high-tension A term applied to circuits having dangerously high voltages, of the order of thousands of volts.

high-vacuum phototube A phototube that is evacuated to such a degree that its electrical characteristics are essentially unaffected by gaseous ionization. In a gas phototube, some gas is intentionally introduced.

high-vacuum rectifier A vacuum-tube rectifier in which conduction is entirely by electrons emitted from the cathode.

high-vacuum tube A vacuum tube evacuated to such a degree that its electrical characteristics are essentially unaffected by gaseous ionization.

hill-and-dale recording A type of phonograph recording in which the cutting stylus of the sound recorder moves up and down rather than from side to side during recording. Also called *vertical recording*.

Hittorf tube An early form of cathode-ray tube, containing a concave cathode that focuses the electron stream on a platinum screen and makes it red hot.

H NETWORK

H network A network composed of five impedance branches, two being connected in series between an input terminal and an output terminal, two others being connected in series between another input terminal and another output terminal, and the fifth being connected from the junction point of the first two branches to the junction point of the second two branches (forming the crossbar of the H).

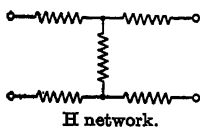

hodoscope An apparatus for tracing the paths of cosmic rays by means of an array of small Geiger counters, each of which is connected with a neon lamp that flashes as the counter is set off by a cosmic particle.

hold controls In a television receiver, two manually adjusted controls that change the frequencies of the oscillators in the horizontal and vertical sweep circuits.

hollow pipe 1. A concentric line. 2. A metal cylinder used as a wave guide or for other purposes in ultrahigh-frequency equipment.

Holtz tube A vacuum tube having funnel-shaped glass constrictions pointing in one direction. A high-frequency discharge passes much more readily in this direction than in the opposite.

homing The procedure involved in flying to a radio station guided by the use of the aircraft radio direction finder, without regard to position fixes obtained from off-line stations.

homing device 1. Any automatic device that starts up in the correct direction of motion or rotation at all times. A nonhoming device may first go in the opposite direction to the end of its travel. 2. A radio device that guides an aircraft to an airport or to the site of a radio transmitter.

homodyne reception A system of radio reception for suppressed carrier systems of radio telephony, in which the receiver generates a voltage having the original carrier frequency and com-

bines it with the incoming signal. Sometimes called *zero-beat reception*.

homogeneous Of the same kind or nature throughout. The opposite of heterogeneous.

homologous field A field in which the lines of force in a given plane all pass through one point. The electric field between two coaxial charged cylinders is an example.

homopolar Electrically symmetrical.

homopolar generator A generator in which all the poles presented to the armature are of the same polarity. Direct-current machines usually have a single pair of poles, each pole completely surrounding the armature, so that the armature conductor always cuts magnetic lines of force in the same direction. A pure direct current is thus produced without commutation.

honeycomb coil A coil wound in a criss-cross manner to reduce distributed capacitance. Also called *lattice-wound coil*.

hookup A diagram showing circuit connections for radio or electrical equipment.

hop An excursion of a radio wave from the earth to the ionosphere and back to earth in traveling from one point to another. Usually used in such expressions as single-hop, double-hop, and multihop. The number of hops is called the order of reflection.

horizon The apparent or visible junction of earth and sky as seen from any specific position on or above the earth. It bounds that part of the earth's surface that is reached by the direct wave of a radio station. The distance to the horizon is affected by atmospheric refraction.

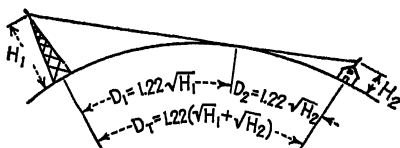

D is in miles H is in feet

Horizon calculations, neglecting refraction and diffraction of radio waves.

horizontal 1. Perpendicular to the direction of gravity. 2. In the direction of or parallel to the horizon. 3. On a level.

horizontal angle of deviation For a radio wave traveling from transmitter to receiver, the horizontal angle between the great-circle path and the direction of departure or arrival along the line of propagation.

horizontal centering control A control provided in a television receiver or cathode-ray oscilloscope to shift the position of the entire image horizontally in either direction on the screen.

horizontal component The projection of a vector on the horizontal reference axis. It is equal to the magnitude of the original vector multiplied by the cosine of the angle which that vector makes with the horizontal. The horizontal component and vertical component are together equivalent to the original vector.

horizontal deflecting electrodes The pair of electrodes that serve to move the electron beam horizontally from side to side on the fluorescent screen of a cathode-ray tube employing electrostatic deflection.

horizontal flyback In a television system, the right-to-left return motion from the end of one scanning line to the beginning of the next. Also called *horizontal retrace* or *line flyback*.

horizontal hold control The hold control that changes the frequency of the horizontal sweep oscillator in a television receiver.

horizontally polarized wave A linearly polarized wave whose direction of polarization is horizontal.

horizontal polarization Transmission of radio waves in such a way that the plane of polarization is horizontal, parallel to the surface of the earth.

horizontal retrace
Horizontal flyback.

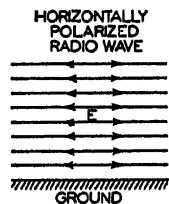

Horizontal polarization.

horizontal sweep The scanning motion from left to right across a picture or scene being televised.

horizontal synchronizing impulse The impulse transmitted after each line is scanned in a television system, for the purpose of keeping the receiver in synchronism with the transmitter. Also called *line synchronizing impulse*.

horn An acoustic transducer (energy-transferring device) consisting of a tube having varying cross-sectional area. The small end is the throat, and the large end is the mouth.

horn arrester A lightning arrester in which the spark gap has upwardly projecting diversion horns of thick wire, up which the arc travels as soon as it is formed. When the arc reaches the widest part of the gap, it extinguishes itself.

horn gap A spark gap with divergent electrodes.

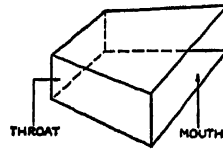

Metal horn, whose throat is fitted to window cut in wave guide, is used to radiate microwave energy as narrow beam.

horn radiator A metal horn whose throat is tightly fitted to a window cut into the sheath of a wave guide, so that the guide will radiate energy into space in a narrow beam.

horsepower A unit of power equal to 550 foot-pounds per second, and electrically equivalent to very nearly 746 watts.

horseshoe magnet A permanent magnet or electromagnet bent into the shape of a horseshoe or having parallel sides like a U, to bring the two poles near each other.

hot cathode A cathode in which electron emission is produced by heat.

hot-cathode tube A vacuum tube in which one of the electrodes, invariably the cathode, is electrically heated, usu-

HOT-CATHODE X-RAY TUBE

ally to incandescence, in order to produce electron or ion emission from that electrode. Usually called *thermionic tube*.

hot-cathode X-ray tube A high-vacuum X-ray tube in which the cathode is heated by current flow through a filament in order to produce emission of electrons.

hot-wire ammeter An instrument in which current is measured by sending it through a fine wire, which is thereby heated. The resulting expansion or sag of the wire is used to deflect the meter pointer. It will measure either alternating current or direct current since both have the same heating effect. Also called *thermal ammeter*.

hot-wire anemometer An instrument for measuring the velocity of wind or a moving gas by means of its cooling effect on an electrically heated wire.

hot-wire gage A pressure gage that depends on the cooling effect of the gas upon a hot filament. An improved version is the Pirani gage.

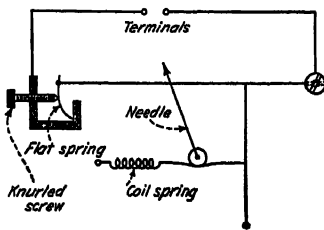

Circuit of a hot-wire instrument.

hot-wire instrument A measuring instrument in which a known fraction or all of the current to be measured passes through a fine wire, heating the wire. The resultant expansion or sag of the wire is used to deflect a pointer or mirror. Hot-wire instruments can be used for both alternating and direct currents.

hot-wire microphone A microphone that depends for its operation on the change in resistance of a hot wire due to the change in temperature caused by the cooling effect of the particle velocity in a sound wave.

hot-wire voltmeter A hot-wire ammeter having a suitable series resistance for voltage measurements.

howl An undesirable prolonged sound produced by a radio receiver or audio-frequency amplifier system because of either electric or acoustic feedback.

hp Abbreviation for horsepower.

H pad An attenuation network in which the elements are arranged in the form of the letter H, as in an H network.

H particle A positive hydrogen ion or proton resulting from bombardment by alpha rays or swiftly moving positive ions.

hr Abbreviation for hour.

Hughes induction balance An instrument used for detecting the presence of metal. Two secondary coils are connected in opposition to each other, in series with headphones. The primary coils are in series with a microphone or a source of alternating current. When the mutual inductance of the two pairs of coils is exactly the same, no sound is heard in the phones. The presence of a mass of metal near one pair of coils upsets the balance, and a tone is heard in the phones.

hum A low audio frequency, equal to or twice the power-line frequency, heard in the background of a received radio program due to improper filtering or a defect in the alternating-current power pack of the receiver or to a power-supply defect in the transmitter.

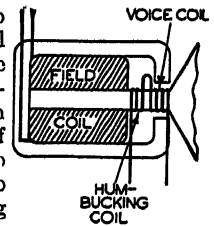

Location of hum-bucking coil in an electrodynamic loudspeaker.

humidity The amount of moisture in the atmosphere. Absolute humidity is the amount of water vapor present in a given volume of air. Relative humidity is the ratio of the amount of water vapor actually present to the greatest amount possible at a given temperature, expressed as a percentage.

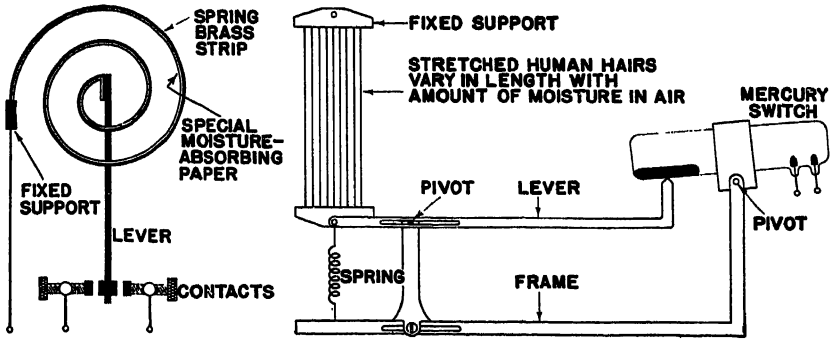

Humidity detector circuits. Both types serve to close a circuit in response to a change in humidity.

humming A sound produced by transformers having loose laminations or due to magnetostriction effects in iron cores. The frequency of the sound is twice the power-line frequency.

hum modulation Hum that is heard in a receiver only when a station is tuned in.

hunting A condition of instability, such as alternate lead and lag of a synchronous motor with respect to the alternating current or to another rotating machine, or overcorrection by a thermostat, engine governor, or other control device and resultant large fluctuations in the quantity that the control device is intended to keep constant.

Huygens principle An important principle of wave propagation, stating in essence that every point on an advancing wave front acts as a source of disturbance and sends out waves, the resultant effect of which constitutes propagation of the wave as a whole.

H wave Another designation for *TE* wave (transverse electric wave), one of the two classes of electromagnetic waves that can be sent through wave guides. An *H* wave possesses longitudinal magnetic force, whereas an *E* wave possesses longitudinal electric force. The first subscript numeral following the letters gives the order of the wave, corresponding to the number of vibrations or half-period variations of the field along diameters of a circular

wave guide or along the *x* coordinate of a rectangular guide. The second subscript numeral gives the mode of the wave, corresponding to the number of vibrations or half-period variations of the field in a radial direction between the center and the walls, counting the outermost (the wall or sheath) as one, or the number of vibrations along the *y* coordinate of a rectangular wave guide.

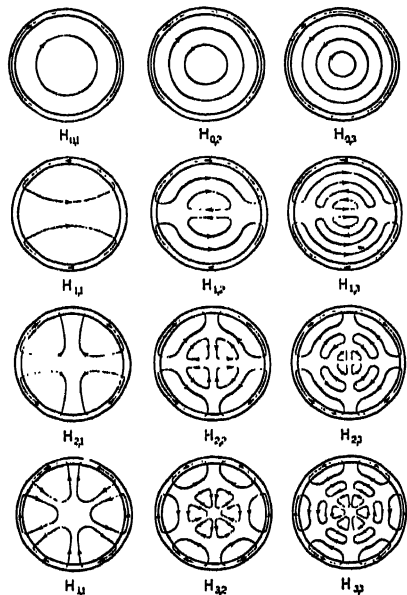

Electric force patterns for *H* waves in circular wave guides. These waves are propagated through guides at frequencies of the order of 1,000 megacycles and higher.

HYBRID COIL

hybrid coil A single transformer having effectively three windings that, within certain limitations, perform the functions of a hybrid set.

hybrid electromagnetic wave An electromagnetic wave having both transverse and longitudinal components of displacement.

hybrid set Two or more transformers interconnected to form a network having four pairs of accessible terminals to which may be connected four impedances so that the branches containing them may be made conjugate in pairs.

hybrid transformer A hybrid coil.

hydroelectric Pertaining to the production of electricity by means of water power.

hydrogen A gas. It has the simplest known atom, consisting of only one proton and one electron.

hydrogen electrode An electrode composed of platinum covered with platinum black, around which a stream of hydrogen is bubbled. It furnishes a standard electrode potential for comparison with other electrode potentials.

hydrometer An instrument, usually in the form of a glass float weighted at its bottom and having a calibrated stem, showing by its depth of immersion the specific gravity of the liquid in which it is placed. Used to determine the state of charge of a storage battery, since the condition of the battery is closely related to the specific gravity of the electrolyte.



Hydrometer.

hydrophone An arrangement of submerged microphones and associated amplifiers, used mainly on vessels to detect the approach of submarines or other craft.

hygrometer An instrument for measuring the humidity of the atmosphere.

hygroscopic Readily absorbing and retaining moisture.

hyperfrequency waves A term used by some to designate microwaves, having wavelengths in the range from 1 centimeter to 1 meter.

Hypernik An iron-nickel alloy having high permeability and low hysteresis loss at low magnetic induction. It is used chiefly for the cores of instrument transformers.

Hypex horn A horn having throat-resistance characteristics such as to give a rise in response at low frequencies.

hypothesis An assumption made as a basis for investigation or reasoning.

hysteresigraph An instrument that automatically traces the hysteresis curve for a specimen of magnetic material.

hysteresimeter An instrument for testing the magnetic characteristics of iron samples.

hysteresis 1. An effect in which the magnitude of a resulting quantity is different during increases in the magnitude of the cause than during decreases. It is due to internal friction in a substance and is accompanied by production of heat within the substance. The name is derived from a Greek word meaning to lag. 2. Magnetic hysteresis occurs when a ferromagnetic substance is subjected to a varying magnetic field and causes the magnetic induction to lag behind the changes in magnetizing force. 3. Electric hysteresis occurs when a dielectric material is subjected to a varying electric field as in a capacitor in an alternating-current circuit. 4. Elastic hysteresis occurs when an elastic solid is subjected to varying stress.

hysteresis error The difference between the readings of a measuring instrument containing iron when the current is brought up to a definite value and when the current is reduced from a larger value to that same definite value.

HYSTERESIS METER

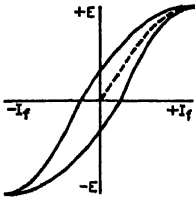

Hysteresis loop.

hysteresis loop A curve (usually with rectangular coordinates) for a magnetic material in a cyclically magnetized condition that shows for each value of the magnetizing force two values of magnetic induction, one when the magnetizing force is increasing and the other when it is decreasing. It is obtained by plotting magnetic inten-

sity H against the resulting magnetic induction B for a complete magnetization cycle (from zero to maximum positive polarity to zero to maximum negative polarity and back to zero).

hysteresis loss The power loss in an iron-core transformer or other alternating-current device due to magnetic hysteresis.

hysteresis meter An instrument for measuring the amount of hysteresis loss in a ferromagnetic material independently of other losses. It usually depends on the torque produced when the test specimen is placed in a rotating magnetic field or is rotated in a stationary magnetic field.

I Roman numeral for 1.

I Symbol used for designating a current in amperes.

i Symbol used for denoting the instantaneous value of a current in amperes.

I_p Symbol commonly used for the plate current of a vacuum tube.

IC Abbreviation for internal connection. Used on tube base diagrams to indicate a base pin having an extra lead brought out through the seal for manufacturing purposes only, as for flashing the getter or activating the cathode. Base pins marked IC should never be connected to a circuit.

ICI standard observer A colorimeter standard embodying the reactions of 17 normal persons to colors. The definition of the standard observer consists of three functions of wavelength, showing the relative amounts of three primary stimuli required to color match the various parts of the equal-energy spectrum.

iconoscope A cathode-ray tube used in a television camera to convert an optical image into corresponding electrical impulses by scanning the image on a mosaic screen with an electron beam. Originally a trademark for a tube of this type developed by the Radio Corporation of America.

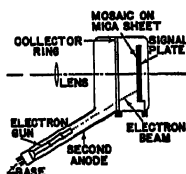

Iconoscope details.

iconoscope camera An electronic television camera using an iconoscope.

icw Abbreviation for interrupted continuous waves.

ID Abbreviation for inside diameter.

ideal bunching The theoretical condition in which the bunching of electrons in a velocity-modulation tube would give a single infinitely large current peak during each cycle.

ideal transformer A theoretically perfect transformer providing 100 per cent transfer of energy with no losses.

identification friend or foe Popular name for electronic equipment used on ships, aircraft, and ground stations for identification purposes. Commonly abbreviated iff.

idiochromatic Having photoelectric properties characteristic of the material of the pure crystal itself, and not due to foreign matter. A crystal is allochromatic when its photoelectric properties are due to microscopic particles occurring naturally in a crystal or as a result of exposure to certain radiations.

idler pulley A pulley used only for tightening a belt or changing its direction. The shaft of the pulley does not drive any other part.

idler roller An intermediate wheel or roller sometimes used to transmit power from a pulley on the motor shaft to the rim of the turntable in a sound recorder.

idometer An instrument for measuring the uniformity of manufactured products. It may check the thickness of sheets of insulating material that are passing between the plates of a capacitor by indicating the variations in capacitance on a capacitance bridge.

i.e. Abbreviation for Latin *id est*, meaning that is.

IEC Abbreviation for International Electrotechnical Commission.

IMAGE ANTENNA

IES Abbreviation for Illuminating Engineering Society.

i-f Abbreviation for intermediate frequency. Same abbreviation used for noun as for adjective.

iff Popular abbreviation for electronic equipment used on ships, aircraft and ground stations for identification purposes. The letters stand for identification friend or foe.

ignition coil An iron-core transformer having an open core, a heavy primary winding connected to a battery or other direct-voltage source through a vibrating armature contact, and a secondary winding having many turns of fine wire. It converts a low direct voltage to a value of the order of 20,000 volts, required to produce a spark for ignition purposes in gasoline engines.

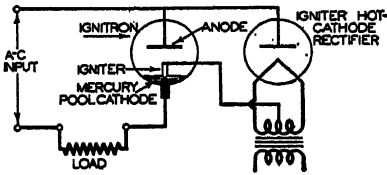

Ignitor circuit for an ignitron.

ignitor An electrode that is partly immersed in the mercury-pool cathode of an ignitron and used to initiate conduction at the desired points in each cycle.

ignitron A gas-discharge tube with a pool-type cathode (liquid or solid) in which an ignitor electrode is employed

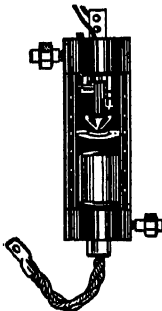

Ignitron, with part of metal envelope out away to show the electrode.

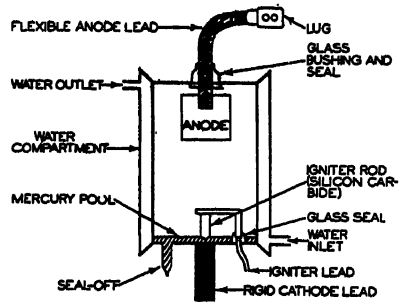

Construction of a typical ignitron.

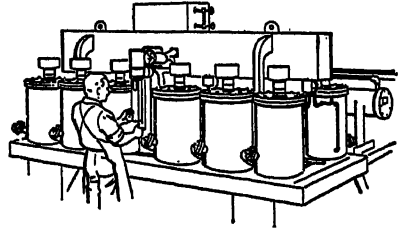

Three-phase ignitron unit.

to control the starting of the unidirectional current flow in each operative cycle. The pool is usually mercury, and the ignitor immersed in the pool is energized by an auxiliary circuit.

- illumination** 1. The amount of light per unit area of surface (the density of the luminous flux on a surface). Illumination varies directly with the intensity (candle power) of the light source, and inversely as the square of the distance between the source and the surface. 2. The act of illuminating, or the state of being illuminated.

illuminometer A portable photometer designed to measure the illumination on a surface.

- image** 1. An optical counterpart of an object, as a real image or virtual image. 2. A fictitious electrical counterpart of an object, as an electric image or image antenna. 3. The scene reproduced by a television or facsimile receiver.

image antenna The fictitious electrical counterpart of an actual antenna, acting mathematically as if it existed in the ground directly under the real antenna.

IMAGE ATTENUATION CONSTANT

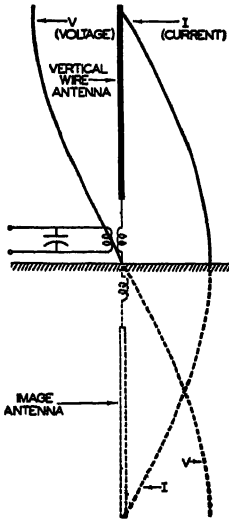

Image antenna for a simple Marconi antenna.

image attenuation constant The real part of the transfer constant.

image dissector A cathode-ray tube developed for television cameras by P. T. Farnsworth. It converts a scene into corresponding electrical impulses that form the video signal.

image distortion Failure of the reproduced image in a television receiver to appear the same as that scanned by the television camera.

image frequency In a superheterodyne receiver in which the oscillator frequency is always higher than the incoming signal frequency, the image frequency is above the incoming signal frequency by twice the intermediate-frequency value, and is hence equal to the sum of the oscillator and intermediate frequencies.

image impedances In a transducer (energy-transferring device), the impedances that will simultaneously terminate each pair of terminals of the transducer in such a way that at each pair of terminals the impedances in both directions are equal.

image interference In a superheterodyne receiver, the condition in which a station broadcasting on the image

frequency for a particular tuning-dial setting is heard along with the desired station. Both stations differ from the oscillator frequency by the intermediate-frequency value, and the receiver circuits do not have sufficient selectivity to reject the higher-frequency undesired signal.

image-interference ratio In a superheterodyne receiver, a rating indicating the effectiveness of the preselector in rejecting signals at the image frequency.

image phase constant The imaginary part of the transfer constant.

image ratio Image-interference ratio.

image reconstructor The cathode-ray tube or other device employed in a television receiver to convert the video signals into an image of the scene originally televised.

image reproducer An image reconstructor.

image response The degree to which a superheterodyne receiver responds to a signal at its image frequency.

impact excitation Starting of damped oscillations in a radio circuit by a sudden surge, such as that produced by a spark discharge. Also called *shock excitation*.

impact-excited transmitter A spark transmitter having no oscillatory circuit. Its frequency is determined by the electrical constants of the antenna circuit through which its capacitor discharges each time a spark is produced at the gap.

impact fluorescence Fluorescence produced in atoms of one element by collisions with excited atoms of another element. Also called *impact radiation*.

impact radiation Impact fluorescence.

impedance The ratio of the effective value of the potential difference between the terminals under consideration to the effective value of the resulting current in an alternating-current circuit. Impedance is a com-

combination of resistance R and reactance X , is measured in ohms, is designated by Z , and is an indication of the total opposition that a circuit offers to the flow of alternating current or any other varying current at a particular frequency. $Z = \sqrt{R^2 + X^2}$.

impedance bridge A bridge used to measure the combined resistance and inductance of a device. One type utilizes an audio-frequency voltage source, with a headphone in place of the usual galvanometer. Known variables, such as resistances and inductances, are adjusted in one arm of the bridge until a balance is obtained as indicated by no sound in the headphone.

impedance coil A choke coil.

impedance compensator An electric network designed to be associated with another network or a line to give the impedance of the combination a desired characteristic with frequency over a desired frequency range.

impedance coupling Coupling provided by an impedance connected between two circuits.

impedance match The condition in which the impedance of a connected load is equal to the internal impedance of the source, thereby giving maximum transfer of energy from source to load.

impedance-matching transformer A transformer used to obtain an impedance match between a source and load.

impedance triangle A diagram consisting of a right-angle triangle with sides proportional to the resistance and reactance, respectively, of an alternating-current circuit and with the hypotenuse representing the impedance of the circuit. The cosine of the angle between the sides representing resistance and impedance is the power factor of the circuit.

impedor A term sometimes used in place of impedance, to describe any circuit or circuit element having impedance. It corresponds in phraseology to resistor, inductor, and capacitor.

impregnated Having spaces filled with a substance having good insulating properties.

impressed voltage The voltage applied to a circuit or device.

impulse A surge (transient variation in current or voltage) having unidirectional polarity. An oscillatory impulse has both positive and negative polarity values.

impulse-driven clock An electric clock in which the hands are moved forward at regular intervals by current impulses controlled by a master clock.

impulse excitation A method of producing oscillating current in a circuit, in which the duration of the impressed voltage is relatively short compared with the duration of the current produced.

impulse generator 1. An electric apparatus suitable for the production of high-voltage surges used for testing insulators and for other purposes. Also called *surge generator*, and sometimes popularly known as *lightning generator*. 2. An oscillator circuit that generates electric impulses for synchronizing purposes in a television system.

impulse noise Noise due to a disturbance having an abrupt change and of short duration, or to a succession of such disturbances.

impulse radiation Radiation resulting from impacts of rapidly moving particles upon a body of matter. Thus, X rays are impulse radiation produced by impacts of electrons.

impulse ratio The ratio of the voltage required to make a spark jump between two terminals when the voltage is suddenly applied, to the voltage which, when gradually increased from zero, produces the same spark.

impulse separator In a television receiver, the circuit that separates the horizontal synchronizing impulses in the received signal from the vertical synchronizing impulses.

IMPULSE-TYPE TELEMETER

impulse-type telemeter A telemeter that employs electric impulses as the translating means.

in. Abbreviation for inch.

incandescent Glowing and giving off light due to heat.

incandescent lamp An electric lamp in which the light is produced by electric current flowing through a filament of resistance material, heating it to incandescence.

inching Quickly repeated opening and closing of a circuit to produce small movements of the driven machine. Also called *jogging*.

incidence angle The angle between an approaching light ray or emission and the perpendicular (normal) to the surface in the path of the ray.

incident light The direct light that falls on a surface.

incident wave A wave traveling through a medium having certain propagation characteristics and impinging on a medium having different propagation characteristics.

inclination The angle which a line, surface, or vector makes with the horizontal. Thus, magnetic inclination, also called magnetic dip, is the angle that the magnetic field of the earth makes with the horizontal at a particular location.

inclinometer An instrument for measuring inclination. A magnetic needle pivoted in a vertical plane is used to indicate the magnetic inclination of the earth's magnetic field.

increment A change in the value of a variable. It is usually a small amount added to the given value of the variable.

incremental hysteresis loss The hysteresis loss when a magnetic material is subjected to a pulsating magnetizing force.

incremental permeability The ratio of the cyclic change in magnetic induction to the corresponding cyclic change

in magnetizing force when the mean magnetic induction differs from zero.

index of cooperation In rectilinear scanning, the product of the total length of a scanning line by the number of scanning lines per unit length.

index of modulation The modulation factor.

index of refraction The ratio of the speeds of a light ray or other radiation in two different materials. It determines the amount the ray will be refracted or bent when passing from one material to the other, such as from air to water.

indicating instrument An instrument (meter) in which the present value of the quantity being measured is indicated by the position of a pointer relative to a scale.

indicating lamp A small lamp used to indicate the position of a device or the condition of a circuit.

indicator 1. An instrument used to detect the presence of an electrical quantity without necessarily measuring it accurately. 2. An electromagnetic signaling device used to indicate which of a number of possible circuits has been used to make a call signal. 3. A pressure recorder for internal-combustion or steam engines. A recent version for high-speed engines depends on the change in capacitance between two disks, one of which is deformed by the pressure.

indicator drop An indicator for signaling, consisting of a hinged flap normally held up by a catch. The catch is released by an electromagnet, allowing the flap to drop when a signal is made.

indirect-arc furnace An arc furnace in which the heat-producing arc is formed between two or more electrodes.

indirectly heated cathode A cathode to which heat is supplied by an independent heater element in a thermionic tube. Also called *equipotential cathode* or *unipotential cathode*.

indirect scanning Scanning in which a narrow beam of light is moved across the area being televised and the light reflected from each illuminated elemental area in turn is picked up by one or more phototubes. Formerly used in mechanical television systems.

indirect wave The sky wave, received after reflection from ionosphere layers.

indoor antenna A receiving antenna located entirely inside a building but outside the radio receiver. It may be a wire strung in an attic, between walls, around the walls, under a rug, etc.

induced Produced as a result of exposure to the influence or variation of an electric or magnetic field.

induced charge An electrostatic charge produced on an object by the electric field that surrounds a near-by object.

induced current A current due to an induced voltage.

induced voltage A voltage produced in a circuit by a change in the number of magnetic lines of force passing through a coil in the circuit.

inductance That property of an electric circuit or two neighboring circuits which determines how much electromotive force will be induced in one of the circuits by a change of current in either of them. Inductance is measured in henrys and designated by L .

inductance bridge An instrument similar to a Wheatstone bridge, used to measure an unknown inductance by comparing it with a known inductance.

inductance-tube modulation A method of modulation employed in frequency-modulated transmitters, in which an oscillator control tube acts as a variable inductance in parallel with the tank circuit of the radio-frequency oscillator tube, causing the oscillator frequency to vary in proportion to the audio-frequency voltage applied to the grid of the oscillator control tube.

induction The act or process by which an object is electrified, magnetized, or

given an induced voltage by exposure to a field. In electrostatic induction (also called electric induction), an object is charged by bringing it into the electric field of a charged object. In magnetic induction, an object is magnetized by bringing it into the magnetic field of an electromagnet or permanent magnet. In electromagnetic induction, a voltage is produced in a circuit by varying the magnetic field which is linked with that circuit. Self-induction is production of a voltage in a circuit by a varying current in that same circuit. Mutual induction is production of a voltage in a circuit by varying current in an adjacent circuit.

induction accelerator An electronic device originally developed by D. W. Kerst. It speeds electrons just as a cyclotron speeds positive particles. Electrons emitted from the filament of a doughnut-shaped glass vacuum tube are accelerated in gradually contracting orbits by an alternating-current electromagnet and eventually strike a target, producing high-energy photons or X rays. Also called *betatron* or *rheotron*.

induction brazing An electric brazing process in which the heat is obtained from induced current.

induction coil 1. A device for changing direct current into high-voltage alternating current. Its primary coil contains relatively few turns of heavy wire, and its secondary coil, wound over the primary, contains many turns of fine wire. Interruption of the direct current in the primary by a vibrating-contact arrangement induces a high voltage in the secondary. 2. A transformer used in a telephone set for interconnection of the transmitter (microphone), receiver (phone), and line terminals.

induction compass A compass whose indications depend on the current generated in a coil revolving in the magnetic field of the earth. Also known as *earth inductor compass*.

induction field That portion of the electromagnetic field of a transmitting

INDUCTION FURNACE

antenna which acts as if it were permanently associated with the antenna. The radiation field leaves the transmitting antenna and travels through space as radio waves.

induction furnace A device for transforming electric energy to heat by electromagnetic induction. Examples are the low-frequency furnace and the high-frequency furnace.

induction generator An induction machine that is driven above its synchronous speed by an external source of mechanical power, so that it generates an alternating voltage.

induction heating The process of transferring the energy in an alternating magnetic field into a metal by induction and there converting it into heat.

induction instrument A meter that depends for its operation on the reaction between magnetic flux set up by current in fixed windings and other currents set up by electromagnetic induction in conducting parts of the moving system.

induction loudspeaker A loudspeaker that depends for its operation on the reaction between the magnetic flux set up by an audio-frequency current in fixed windings and other currents set up by induction in conducting parts of the moving system.

induction machine An alternating-current machine having a magnetic circuit interlinked with two electric circuits or two sets of circuits rotating with respect to each other, with power being transferred from one circuit to the other by electromagnetic induction. The speed of operation is not proportional to the associated frequency. Examples are induction motors, induction generators, and certain types of frequency converters and phase converters.

induction motor An electric motor in which electric power delivered to the primary circuit (usually consisting of stationary field coils) is converted into mechanical power. The secondary circuit or the rotor is short-circuited or closed through a suitable circuit, and

follows the rotating field of the primary at a speed slightly below that of the field. Examples are the wound-rotor induction motor and the squirrel-cage induction motor.

induction resistance welding A resistance welding process in which the heating current is caused to flow in the parts to be welded by electromagnetic induction, without any electric contact between the source and the work.

induction voltage regulator A type of transformer having a primary winding connected in parallel with a circuit and a secondary winding in series with the circuit, used to adjust gradually the voltage or phase relation of the circuit by changing the relative position of the primary and secondary windings.

inductive Pertaining to inductance, to the inducing of a voltage through mutual inductance, or to the inducing of an electrical charge by electrostatic induction.

inductive circuit A circuit containing a higher value of inductive reactance than capacitive reactance.

inductive coupling The association of one circuit with another by means of inductance that is common or mutual to the two circuits. This term ordinarily means coupling by means of mutual inductance provided by a transformer. Coupling by means of self-inductance that is common to two circuits is called direct inductive coupling.

inductive feedback Feedback of energy from the plate circuit of a vacuum tube to the grid circuit through an inductance or by means of inductive coupling.

inductive load A load that is predominantly inductive, so that the load current lags behind the load voltage. Also called *lagging load*.

inductive-output tube A tube in which output energy is obtained from the electron stream by electric induction between a cylindrical electrode or electrodes extended along the length of the tube and the electron stream

that flows through, but is not collected by the electrodes.

inductive reactance That type of reactance which is due to the inductance of a circuit or coil. It is measured in ohms, designated by X_L , and is equal to the inductance in henrys multiplied by 2π times the frequency in cycles ($X_L = 2\pi fL$).

inductor A circuit component designed so that inductance is its most important property. Usually known as *coil*.

industrial instrumentation The measurement and control of temperature, humidity, pressure, speed, properties of materials, dimensions, radiant energy, liquid flow, liquid position, process times, quantities, and other measurable magnitudes.

inert gas One of a group of chemically inert gases, including helium, neon, argon, krypton, and xenon. Also called *noble gas* and *rare gas*.

inertia Inertia is opposition to change. It is a property common to all forms of matter, in which it will either remain at rest or in uniform motion in the same straight line until acted on by an external force.

infinite Larger than any fixed boundary, or larger than any possible assigned number.

infinite line A transmission line having characteristics corresponding to those which would be obtained with an ordinary line that is infinitely long.

infinitesimal Extremely small, approaching zero as a limit.

infradyne reception A term sometimes used for superheterodyne reception in which the intermediate-frequency value is higher than the carrier frequency of the received signal.

infrared The range of invisible radiation frequencies which adjoins the visible red spectrum and extends up to radio waves. Infrared rays can be detected and measured with phototubes or with certain photographic films. Infrared beams are used in some photoelectric burglar-alarm systems.

infrared microscope An apparatus in which a projection microscope employing an infrared light source produces on the cathode of an electron image tube an optical image that causes corresponding emission of electrons from different points on the cathode surface. Systems of electron lenses focus the emitted electrons on a fluorescent screen in the tube, producing there a visible image.

infrasonic Having a frequency below the audible range. Frequencies above the audible range are called ultrasonic or supersonic.

initial permeability The normal permeability when both the magnetizing force and the magnetic induction are vanishingly small.

initiating Causing an action to start. A qualifying term applied to a device whose operation must precede that of other devices involved in an operating sequence. Thus, an initiating relay may set off a sequence of operations in other relays.

injection grid A grid introduced into a vacuum tube in such a way that it exercises reasonable control over the electron stream without causing appreciable interaction between the screen grid and control grid. The injection grid is used as a means of introducing the oscillator signal into the mixer stage in some superheterodyne receivers.

ink recorder A recorder that employs an ink-filled pen or capillary tube to produce the graphic record.

ink-vapor recording In facsimile, a form of electromechanical recording in which vaporized ink particles are directly deposited on the record sheet.

inphase The condition existing when waves of the same frequency pass through their maximum and minimum values of like polarity at the same instant.

inphase component The component of an alternating voltage or alternating current due to resistance alone, independently of reactance.

INPUT

- input** 1. The current, voltage, or power fed into a circuit or device. 2. The terminals to which signal voltage is applied in a circuit or device.
- input admittance** The reciprocal of input impedance.
- input capacitance** The sum of the direct capacitances between the control grid and the cathode of a vacuum-tube circuit.
- input impedance** A value equal to the applied alternating voltage divided by the resulting alternating current through a circuit or device.
- input resonator** The buncher resonator in a velocity-modulation tube. It modifies the velocity of the electrons in the beam.
- input transformer** A transformer used to transfer energy from an alternating-voltage source to the input of a circuit or device. Its function is usually to provide a correct impedance match.
- insertion loss** The loss caused at a given frequency by the insertion of apparatus in a transmission system. It is the ratio, expressed in decibels, of the power delivered before the insertion to the power delivered after the insertion.
- inside spider** A flexible device placed inside a voice coil to center it accurately with respect to the pole pieces of a dynamic loudspeaker.
- inspectoscope** An instrument for viewing quartz crystals while immersed in oil, to locate the various mechanical faults, to determine the approximate direction of the optical axis, and to reveal regions of optical twinning.
- instantaneous** A qualifying term indicating that no time delay has been purposely introduced in the action of a device, such as a relay.
- instantaneous disk** A blank disk that can be played back on a phonograph immediately after being cut on a sound recorder.
- instantaneous power** The rate at which electric energy is being transmitted at a particular instant. It is equal to the product of the instantaneous current by the instantaneous voltage.
- instantaneous recording** A recording that may be used immediately after cutting or embossing, without further processing.
- instantaneous sound pressure** The total instantaneous pressure at a point in a medium containing sound waves, minus the static pressure that exists when no sound waves are present. The unit is the dyne per square centimeter. Often called *excess sound pressure*.
- instantaneous value** The value of an alternating quantity at any particular point in its cycle.
- in step** In phase.
- instrument** 1. A device for measuring the value of a quantity under observation. It may either indicate or record the value. Also called meter when the context is such as to prevent confusion with meters that register quantity with respect to time. 2. A contrivance that produces musical sounds. 3. A tool, implement, or device by means of which any work is performed or result is effected.
- instrument landing station** A special radio station for facilitating the landing of aircraft.
- instrument multiplier** A highly accurate series resistor used to extend the voltage range of an instrument beyond some value for which the instrument is already complete.
- instrument shunt** A highly accurate special type of low-value resistor connected in parallel with an instrument to extend its current range beyond some value for which the instrument is already complete.
- instrument transformer** A transformer in which conditions of current or voltage and of phase position in the primary circuit are represented with sufficient accuracy in the secondary circuit to permit connecting an instrument to the secondary rather than the

INTEGRATING-SPHERE DENSITOMETER

primary. Used so that only low currents or low voltages are brought to the instrument itself. With a current transformer, the primary winding is inserted in the circuit carrying the current to be measured or controlled. With a voltage transformer, the primary winding is connected across the circuit whose voltage is to be measured or controlled.

insulated carbon resistor A carbon resistor encased in a fiber, plastic, or other insulating housing.

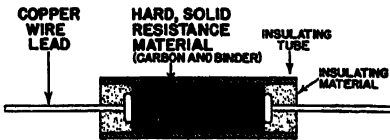

Insulated carbon resistor.

insulated screw eye A wood screw terminating in an insulated eye through which wires may be run and supported. Used extensively for antenna lead-in wires.

insulated series-excited vertical radiator A vertical transmitting antenna that is insulated from the earth, with its exciting voltage induced in a coil connected between the antenna and the ground.

insulating strength A measure of the ability of an insulating material to withstand electric stress without breakdown. It is defined as the voltage per unit thickness necessary to initiate a disruptive discharge. Usually measured in volts per centimeter. Also called *electric strength* and *dielectric strength*.

insulating tape Tape impregnated with insulating material, usually adhesive, used to cover joints in insulated wires or cables.

insulating varnish A varnish having good insulating qualities, applied to coils and windings to improve their insulation and sometimes also to improve mechanical rigidity.

insulation A material having high electric resistance, and therefore suitable for separating adjacent conductors in



Insulated clip.

an electric circuit or preventing possible future contact between conductors. Common materials used for insulation are cotton, silk, rubber, baked enamel, mica, porcelain, glass, etc.

insulation resistance The electric resistance between two conductors separated by an insulating material.



Beehive insulator and nail-it knob.

insulator A device having high electric resistance, used for supporting or separating conductors so as to prevent undesired flow of current from the conductors to other objects.

integrator A mechanical device for determining areas under curves, and hence for performing integration.

integrating circuit A circuit that produces an output voltage substantially in proportion to the frequency and amplitude of the voltage applied to the input circuit.

integrating meter An instrument that adds up or integrates the electrical energy used over a period of time, such as an ordinary electric meter.

integrating photometer A photometer in which the average candlepower from a source in all directions or at all angles in a single plane is determined by a single reading.

integrating-sphere densitometer A photoelectric instrument used to measure the density of sound tracks on motion-picture film or to measure film density itself. A beam of interrupted light is directed through the film into a sphere having a white inside surface, such that the light reflected from any part of the

INTELLIGENCE SIGNAL

sphere is proportional to the total light entering the sphere. A phototube inserted in the wall of the sphere picks up the reflected light and converts it into a corresponding signal that can be amplified and fed to a meter calibrated in density ratings.

intelligence signal Any signal that conveys information.

intensity To increase the brilliance of an image on the screen of a cathode-ray tube.

intensifying screen A thin screen coated with a finely divided substance that fluoresces readily under the influence of X rays. It is used in close contact with the emulsion of a photographic plate or film in X-ray apparatus for the purpose of increasing the effect of the X rays on the film.

intensimeter An instrument used to estimate the quantity of X-ray radiation for the purpose of determining the duration of exposure when using X rays for therapy. Also called *dosage meter* and *dosimeter*.

intensity 1. A general term now used chiefly to signify the strength or value of a current. The symbol I for current comes from this word. 2. The strength or amount of a quantity, as of magnetization, illumination, etc.

intensity level A term used in acoustics to specify the relation of one sound intensity to another. The intensity level is expressed in decibels, and is equal to ten times the common logarithm of the ratio of the intensities. The reference intensity is usually chosen as a sound flux density of 10^{-9} erg per second per square centimeter in air at normal conditions.

intensity of X rays That quality of a beam of X rays which determines the rate of ionization of air at a given point under specified conditions. Intensity is expressed in roentgens per unit of time.

intensity modulation Control of the brilliance of the trace on the screen of a cathode-ray tube in conformity

with the signal. Also called *brilliance modulation*.

intercarrier noise suppression A means of suppressing the noise resulting from increased gain when a high-gain receiver with automatic volume control is tuned between stations. The suppression circuit automatically blocks the audio-frequency input of the receiver when no signal exists at the second detector. Also called *interstation noise suppression*.

intercept 1. The distance from the origin to the point where a line, curve, or surface cuts a particular axis on a graph. 2. To cut off or bound some part of a line or other geometric figure.

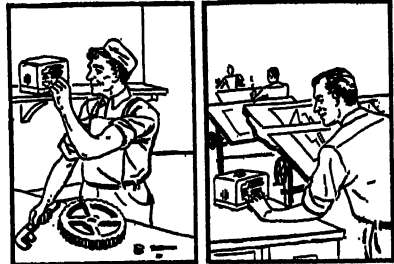

Intercommunication systems permit instant two-way conferences between shop and drafting room.

intercommunication system An audio-frequency amplifier system that provides two-way voice communication between two or more locations. Each station contains a dynamic loud-speaker that also serves as a microphone. The amplifier may be at a central station, or each station may have its own amplifier. Connections between stations may be by means of wires or by means of carrier signals traveling over electric wiring in the building.

interelectrode capacitance The capacitance existing between the electrodes in a vacuum tube.

interference 1. A variety of effects occurring when two or more wave

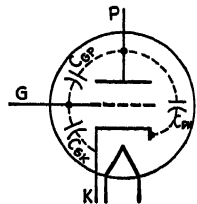

Interelectrode capacitances in a triode.

INTERMEDIATE-FREQUENCY TRANSFORMER LEAD COLOR CODE

trains of either light or radio waves arrive at the same point simultaneously. 2. Undesired radio programs or noises that interfere with reception of a desired radio program.

interference eliminator 1. Any device designed for the purpose of eliminating or reducing interference. 2. A wave trap used to reduce the effects of interference produced by an undesired radio station.

interference filter A device, generally containing some combination of capacitance and inductance, used between a source of man-made interference and a radio receiver to attenuate or eliminate noise signals.

interference guard bands The two bands of frequencies on either side of the communication band and frequency tolerance of a station assignment, provided in order that there shall be no interference between stations having adjacent frequency assignments.

interference pattern The space distribution of pressure, particle velocity, energy density, or energy flux of stationary waves.

interferometer An apparatus used to produce and show interference between two or more wave trains coming from the same large luminous area, and also to compare wavelengths with observable displacements of reflectors or other parts.

interlaced field Interlaced scanning.

interlaced scanning A method of electronic television scanning in which every other line of a frame is covered during one downward sweep of the scanning beam and remaining lines are scanned during the next complete sweep.

interlacing A method of scanning used in television, in which each picture is divided into two or more complete sets of interlacing lines to reduce flicker.

interlock A device actuated by the operation of some other device with which it is directly associated, to govern succeeding operations.

interlock circuit A circuit in which one action cannot occur until one or more other actions have first taken place. The interlocking action is generally obtained with relays.

intermediate frequency In superheterodyne reception, a frequency resulting from the combination of the received frequency with the locally generated frequency, and usually equal to their difference.

intermediate-frequency amplifier In a superheterodyne receiver, the section that amplifies signals after they have been converted to the intermediate-frequency value by the frequency converter.

intermediate-frequency stage An intermediate-frequency amplifier stage in a superheterodyne receiver. It is located between the first detector and the second detector.

intermediate-frequency transformer The transformer used at the input and output of each intermediate-frequency amplifier stage in a superheterodyne receiver for coupling purposes and to provide selectivity.

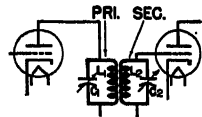

Intermediate-frequency transformer symbol as used in a typical circuit.

intermediate-frequency transformer lead color code Leads of these transformers in radio receivers are identified by the following standard RMA colors: Plate lead—blue; B plus lead—red; grid or diode lead—green; grid return lead—black. For a full-wave transformer the second diode lead will be green-black.

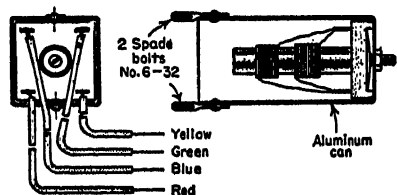

Intermediate-frequency transformer with color-coded leads.

INTERMITTENT CURRENT

intermittent current A unidirectional current that is interrupted at regular or irregular intervals.

intermittent defect A defect that depends on varying conditions in a circuit and is hence not continuously present.

intermittent duty Operation of a machine or apparatus for definitely specified alternate intervals of load and rest.

intermittent rating A rating stating the permissible output of a piece of apparatus when working for alternate periods of load and rest having a definite ratio to each other or when running for a stated period that is insufficient to produce the final temperature.

intermittent reception A radio-receiver complaint in which the receiver operates normally for a time, then becomes defective for a time, with the process repeating itself at regular or irregular intervals.

intermittent service area The area receiving service from the ground wave of a broadcast station but beyond the primary service area and subject to some interference and fading.

intermodulation Modulation of the components of a complex wave by each other, producing new waves whose frequencies are equal to the sums and differences of integral multiples of the component frequencies of the original complex wave.

intermodulation distortion The production of combination-frequency tones at the output by the nonlinearity of an amplifier or network when two or more sinusoidal voltages of specified amplitude are applied at the input. It is expressed as the ratio of the root-mean-square voltage of one or more of the combination frequencies to that of one of the parent frequencies, measured at the output.

intermodulation interference Station interference occurring when the signals from two undesired stations whose frequencies differ by exactly the intermediate-frequency value of a super-

heterodyne receiver are able to pass through the preselector due to poor selectivity. In the mixer-first detector stage, this undesired intermediate-frequency signal interacts with the desired intermediate-frequency signal, with the result that squeals and garbled programs interfere with reception when any desired station is tuned in.

internal resistance The resistance that is inside a battery, generator, or circuit component.

international ampere The value of current that will deposit 0.001118 gram of silver per second from a solution of silver nitrate under certain specified conditions. It is equal to 0.99985 ampere.

international broadcast station A station licensed for the transmission of broadcast programs for international public reception. Frequencies for these stations are allocated from bands assigned (between 6,000 and 26,600 kilocycles) for broadcasting by international agreement.

international communication service A telecommunication service between offices or stations belonging to different countries or between stations of the mobile service, unless these latter are of the same nationality and are situated within the limits of the country to which they belong.

international coulomb An international unit equal to 0.99985 coulomb.

international farad An international unit equal to 0.99952 farad.

International General Radio Regulations The General Radio Regulations of Cairo, 1938, annexed to the International Telecommunications Convention of Madrid, 1932.

international henry An international unit equal to 1.00048 henrys.

international joule An international unit equal to 1.00018 joules.

International Morse code The code universally used for radiotelegraphy. It is used for wire telegraphy in some

INTERZONE POLICE STATION

European countries, and is also known as the *continental code*.

international ohm The resistance at 0° centigrade of a column of mercury 106.300 centimeters long, having uniform cross section and a mass of 14.4521 grams. One international ohm equals 1.00048 ohms.

international radio silence Three-minute periods of radio silence, on the frequency of 500 kilocycles only, commencing 15 and 45 minutes after each hour, during which all radio stations may listen on that frequency for distress signals of ships and aircraft.

international radium standard A standard of radioactivity, consisting of 21.99 milligrams of pure radium chloride.

international system A system of electrical and magnetic units, little used and scheduled to be discarded. It is based on resistance, current, length, and time as the four fundamental quantities. The units of resistance and current (international ohm and international ampere) are arbitrary values that approximately correspond to the absolute ohm and absolute ampere, while the units of length and time are the centimeter and second. Units in this system are preceded by the word *international*.

international volt An international unit equal to 1.00033 volts.

international watt An international unit equal to 1.00018 watts.

interphone system An intercommunication system such as that in an aircraft or other mobile unit.

interpolate To estimate missing values between those which are known. Extrapolate means to estimate values outside the known range.

interpolation The process of finding the value of a function between two known values by a procedure other than the law that is expressed by the function.

interpole An auxiliary pole placed between the main poles of a direct-current generator or motor to produce a flux that assists reversal of current

in the short-circuited armature coil at each instant, thereby reducing sparking at the commutator. Also called *commutating pole*.

interrupted continuous wave A continuous wave that is interrupted at an audio frequency in a substantially periodic manner at a transmitter, in order to produce an audio-frequency tone modulation that makes possible the reception of the resulting code signals with ordinary receivers (without beat oscillators).

interrupter A device for opening and closing an electric circuit rapidly and periodically. It is used in the primary circuit of an induction coil, in doorbells, and in buzzers.

interstage Between stages.

interstage coupling Coupling between vacuum-tube stages.

interstage transformer A transformer used to provide coupling between two vacuum-tube stages.

interstation noise suppression A means of suppressing the noise resulting from increased gain when a high-gain receiver with automatic volume control is tuned between stations. The suppression circuit automatically blocks the audio-frequency input of the receiver when no signal exists at the second detector. Also called *inter-carrier noise suppression*.

interval timer A device for measuring the time interval between two actions. The electronic version may consist of an arrangement for charging a capacitor at a predetermined rate during the time interval being measured, then measuring the quantity of electricity in the capacitor and computing from it the time interval by means of the formula $Q = It$, where Q is the quantity in coulombs, I the current in amperes, and t the time in seconds.

interzone police station A station used by a police department for radiotelegraph communication with similarly licensed stations in adjacent zones or with the nearest interzone police station in case there is no similarly

INTRINSIC CONTACT POTENTIAL DIFFERENCE

licensed station in the adjacent zone, with stations within the zone, and with mobile police units equipped for radiotelegraph reception.

intrinsic contact potential difference

The true potential difference between two perfectly clean metals in contact.

intrusion-detection system

A photoelectric, capacitance-controlled, electric, acoustic, or other system for setting off an alarm that announces the presence of an intruder at the boundaries of a protected area or inside that area.

Invar An alloy of nickel and iron, containing about 36 per cent nickel, which remains essentially constant in length over a wide range of temperature.

inverse feedback A vacuum-tube circuit arrangement in which a voltage is fed back from the plate circuit to the grid circuit in such a way that it is 180 degrees out of phase with the input signal, decreasing the amplification. It is used in radio-frequency circuits to improve the stability by preventing oscillation, and in audio-frequency circuits to reduce distortion and noise in order to permit greater undistorted power output. Also called *degeneration*, *negative feedback*, and *stabilized feedback*.

inverse peak voltage The peak-voltage value existing across a rectifier tube during that half of the cycle in which current does not flow.

inverse photoelectric effect The transformation of the kinetic energy of a moving electron into radiant energy, as in the production of X rays, or in recombination of electrons with ions in a glow discharge tube or fluorescent lamp.

inverse piezoelectric effect The contraction or expansion of a quartz or other crystal along an electric axis when subjected to an electric field in that direction. Also called *electrostriction*.

inverse square law A law of optics which states that the intensity of light varies inversely as the square of the

distance from the source of light. Thus, moving twice as far away gives one-fourth as much light intensity.

inverse voltage The effective-voltage value existing across a rectifier tube during that half of the cycle in which current does not flow.

inversion The process of producing inverted or scrambled speech by beating an audio-frequency signal with a fixed higher audio frequency and using only the lower side band of the resulting beat frequencies. The original low audio frequencies then become high frequencies, and vice versa.

inverted amplifier A two-tube vacuum-tube amplifier stage in which the control grids are grounded and the driving excitation is applied between the cathodes. The grid then serves as a shield between the input and output circuits. The output circuit capacitance is greatly reduced—an important advantage in high-frequency operation.

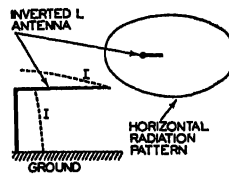

Inverted L antenna.

inverted L antenna An antenna consisting of one or more horizontal wires to which a connection is made by means of a vertical wire at one end.

inverted speech Speech that has been made unintelligible by inverting the frequencies in such a manner as to change the sound completely for secret transmission of transoceanic radio telephone calls yet permit converting it back at the receiving end. Also called *scrambled speech*.

inverter A device for converting direct current into alternating current. It may be electromechanical, as in a vibrator, or electronic, as in a thyatron inverter circuit.

ion The electrified particle formed when a neutral atom or group of atoms gains

or loses one or more electrons. A negative ion has gained electrons; a positive ion has lost electrons.

ion counter A tubular ionization chamber used for measuring the ionization of the air.

ionic focusing Focusing of the electron beam in a cathode-ray tube by varying the filament voltage and temperature, thereby changing the radial electrostatic focusing field that is automatically produced by accumulations of positive ions in the tube. Also called *gas focusing*.

ionic medication The therapeutic use of an electric current to introduce ions of soluble salts into tissues. Also called *medical ionization*.

ionization The process by which molecules of a gas are converted into positive ions by loss of electrons, or into negative ions by gain of electrons. In a vacuum tube, these ions make the tube more conductive and hence permit greater current flow. Ionization can be produced in a number of ways, as by collisions of ions with electrons, by the action of ultraviolet light or other radiation, etc.

ionization chamber An enclosure containing two oppositely charged electrodes in air or some other gas, so arranged that when the gas is ionized, as by X rays or cosmic rays, the resulting ions are drawn to the electrodes. The current through the tube is then a measure of the intensity of the ionizing rays.

ionization current Current flow between two oppositely charged electrodes in an ionized gas.

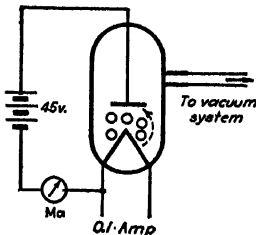

Circuit illustrating an emission-type ionization gage.

ionization gage A pressure gage for measuring the degree of vacuum. It is based on the quantitative relation between pressure and ionization current in a vacuum tube.

ionization potential See *ionizing potential*.

ionization pressure An increase in the pressure within a gaseous discharge tube due to ionization of the gas.

ionize To convert into ions.

ionized layer A Kennelly-Heaviside layer.

ionizing potential The voltage required to ionize an atom or molecule by impact with an electron or by other means. It corresponds to the energy in electron-volts required for ionization.

ion migration A movement of ions produced in an electrolyte by application of an electric potential between electrodes.

ionogen A substance that, when dissolved in a specified medium (usually water), produces an electrolyte capable of conducting electricity.

ionometer 1. An instrument for measuring the quantity or intensity of roentgen rays (X rays). Also called *roentgen meter* or *roentgenometer*. 2. An ionization chamber used to measure the intensity of a radiation that is capable of producing ionization.

ionosphere The upper portion of the earth's atmosphere, beginning at about 30 miles above the surface of the earth, and containing layers of highly ionized air that are capable of bending or reflecting radio waves back to earth. Reflection from the ionosphere makes possible long-distance reception of radio waves. The ionosphere starts with the E_1 and E_2 layers, commonly called the Kennelly-Heaviside layer. Above this are the F_1 and F_2 layers, sometimes collectively called the Appleton layer. Ionosphere layers are responsible for fading, skip distance, and differences between day and night reception.

IONOSPHERIC STORM

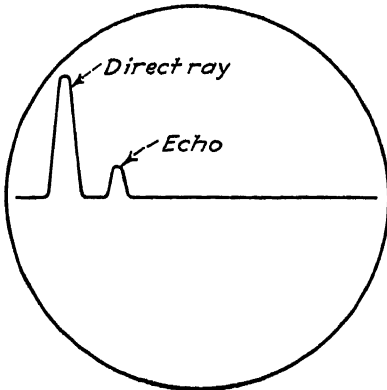

Pulse patterns obtained on cathode-ray tube screen during ionosphere height measurements by radar techniques. Each peak is called a *pip*.

ionospheric storm A period of disturbance in the ionosphere, during which there are erratic and abnormal variations of penetration frequencies, virtual heights, and absorption.

ionospheric wave A radio wave that is propagated by reflection from the ionosphere. Sometimes called a *sky wave*.

ion trap An electrode in the electron gun of a television picture tube, arranged to attract negative ions and prevent them from reaching the luminescent screen. The electrode is usually a metal disk having a small hole in its center.

ipa Abbreviation for intermediate power amplifier.

IR drop The voltage drop produced across a resistance R by the flow of current I through the resistor.

IRE Abbreviation for Institute of Radio Engineers.

iris An iris diaphragm.

iris diaphragm 1. A continuously variable aperture placed on either side of a lens to control the amount of light passing through the lens. 2. An arrangement of adjustable metal leaves like those used in photography, set into a wave guide to regulate the flow of energy. The smaller the aperture or

hole in the diaphragm, the less is the energy passing through the diaphragm position; the remainder of the energy is reflected back.

PR loss Power loss in transformers, generators, connecting wires, and other parts of a circuit due to current flow I through the resistance R of the copper conductors. Also called *copper loss*.

iron-core coil A coil in which iron forms part or all of the magnetic circuit linking its winding. In a choke coil, the core is usually built up of laminations of sheet iron.

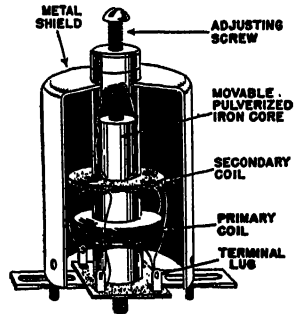

Pulverized iron core in a radio-frequency transformer.

iron-core transformer A transformer in which iron forms part or all of the magnetic circuit linking the transformer windings.

iron loss Power loss occurring in iron cores of electric machines, coils, transformers, etc., due to hysteresis and eddy currents.

iron-vane instrument A measuring instrument in which the movable element is an iron vane.

irradiation The application of X rays, radium rays, or other radiation to a patient or object.

IS Designation for an internal shield. Used on tube-base diagrams to designate the pin that is connected to the shield inside the tube.

isobars Forms of elements having practically the same atomic weight but different atomic numbers and hence

- quite different chemical properties, such as uranium X_1 and uranium X_2 .
- isochronism** Running at exactly identical speeds, as of shafts in some forms of printing telegraph systems.
- isochronous circuits** Circuits having the same resonant frequency.
- isoclinic lines** On a magnetic map, lines passing through points of equal magnetic inclination or dip. Also called *acclinic lines*.
- isodynamic lines** On a magnetic map, lines passing through points of equal horizontal component of the earth's magnetic field.
- isoelectronic** Having the same number of electrons outside the nucleus of the atom.
- isogonal lines** On a magnetic map, lines passing through points of equal magnetic declination.
- Isolantite** A ceramic insulating material widely used in the construction and mounting of radio parts, particularly in ultrahigh-frequency circuits.
- isolating switch** A switch intended for isolating a circuit from its source of power, and normally operated only after the circuit has been opened elsewhere by other means.
- isolation network** A network inserted in a circuit or transmission line to prevent interaction between circuits on each side of the insertion point.
- isomer** One of two or more substances composed of molecules having the same kinds of atoms in the same proportions but different arrangements of those atoms and hence different physical and chemical properties. Isomers with different molecular weights are called polymers; examples are acetylene (C_2H_2) and benzene (C_6H_6).
- isometric** 1. Represented without perspective. In an isometric drawing, parallel lines on the object are made parallel on the drawing, and no vanishing points are used. 2. In crystal structure, having three equal and mutually perpendicular axes.
- isotopes** Varieties of a chemical element, having the same atomic number but different atomic masses.
- isotropic** Having the same properties in all directions.
- isotropic body** A body in which the value of any given property is independent of the direction of measurement.
- iterative impedance** For a nonuniform line or structure constituting a four-terminal transducer (energy-transferring device), the iterative impedance at a pair of terminals is the impedance that will terminate the other pair of terminals in such a way that the impedance measured at the first pair of terminals is equal to this terminating impedance. For a uniform line, it is the same as the characteristic impedance.

J

j Abbreviation for joule.

j Designation used for the complex operator j which is mathematically equivalent to $\sqrt{-1}$.

jack A connecting device to which the wires of a circuit may be attached, and which is arranged for insertion of a plug.

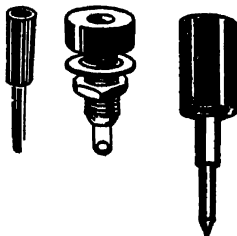

Phone tip, phone-tip jack, and phone-tip plug.

jamming Transmission of disturbing radio signals in such a way as to interfere with reception of signals from another station.

JAN specification Joint Army-Navy specification.

jar A unit of capacitance used in the British Navy, equal to $\frac{1}{100}$ microfarad.

jewel bearing A natural or synthetic jewel, usually sapphire, having a carefully ground conical depression that serves as a bearing for the pivot of a meter movement or as a bearing in other delicate instruments.

jitters In facsimile, distortion in the received picture caused by momentary errors in synchronism between scanner and recorder.

jogging Quickly repeated opening and closing of a circuit to produce small movements of the driven machine. Also called *inching*.

Johnson noise A background noise heard in radio receivers due to thermal agitation in grid circuits.

joule A unit of energy or work. The absolute joule is equal to 10 million ergs. The international joule is equal to the work required to maintain a current of one ampere for one second in a resistance of one ohm. One joule is equal to one watt-second.

Joule effect 1. The heating effect produced by the flow of current through a resistance. 2. The change in the dimensions of a ferromagnetic object when placed in a magnetic field. Also called *magnetostriction*.

Joule's law The rate at which heat is produced in an electric circuit having constant resistance is proportional to the square of the current. The heat in calories is $0.2388I^2Rt$, with R in ohms, I in amperes, and t in seconds. The heat in joules is I^2Rt .

jumper A short length of conductor used to make a connection between terminals, around a break in a circuit, or around an instrument.

junction 1. A joint in a circuit. 2. The point of contact between two dissimilar metals or materials, as in a thermocouple or a copper-oxide rectifier.

junction box A metal or other box into which wires or cables are led and connected to form joints. It provides mechanical protection for the joints.

K

K Designation for the cathode of a vacuum tube.

K Any numerical value that remains constant during a particular investigation.

Karolus cell A light valve depending on the variation in the polarization of a liquid with changes in magnetic field strength.

Karolus system A system of phototelegraphy in which a phototube is employed at the transmitter for scanning the subject copy and a Kerr cell is used at the receiver. Used chiefly in Europe.

kc Abbreviation for kilocycles per second.

keeper A bar of iron or steel placed across the poles of a horseshoe magnet to complete the magnetic circuit when the magnet is not in use, in order to avoid the self-demagnetizing effect of leakage lines.

Kelvin balance An instrument for measuring current by sending it through a fixed coil and a movable coil attached to one arm of a balance, and comparing the resulting force between the coils with the force of gravity acting on a known weight at the other end of the balance arm.

Kelvin scale Temperature measured with a scale having its zero at absolute zero, the lowest possible temperature, but otherwise utilizing the centigrade scale. Add 273.1 to a centigrade value to get the Kelvin value, also known as the absolute value.

Kelvin's law The most economical cross-sectional area for a conductor is that for which the cost of electric energy lost in a given period equals the interest for the same period on the capital involved.

Kennelly-Heaviside layer A region of highly ionized air in the ionosphere, having maximum intensity at about 65 miles above the earth's surface, capable of reflecting or refracting radio waves back to earth under certain conditions. It is made up of E_1 and E_2 layers. Also called *Heaviside layer*.

Kennelly's law The reluctivity in magnetizing a specimen of iron is proportional to the magnetizing force.

kenotron A high-vacuum thermionic tube in which no means is provided for controlling the unidirectional current flow. It thus has two electrodes, a hot cathode and an anode, and is used as a rectifier.

keraunophone A device incorporating radio circuits, used to demonstrate audibly the occurrence of distant lightning flashes.

kernel 1. A line within a current-carrying conductor, along which the magnetic intensity due to the current is zero. 2. The highly stable electron group that remains when a chemically active atom is ionized by the removal of its incomplete outer shell of electrons. Also called *Rumpf* or *core*.

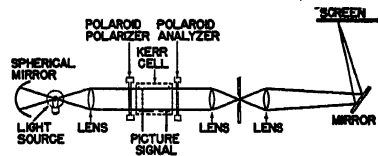

Kerr cell used in one type of television circuit.

Kerr cell A transparent enclosure containing nitrobenzene or some other transparent substance which exhibits electric double refraction and hence can be used to convert a varying voltage into corresponding variations in the intensity of polarized light passing through the cell. Used as a light valve in some mechanical television systems,

KERR EFFECT

because it can be made to modulate a light beam with television signals.

Kerr effect An electrooptical effect in which certain transparent substances become doubly refracting when subjected to an electric field at right angles to a beam of light. Also, the conversion of plane-polarized light into elliptically polarized light when it is reflected from the polished end of a magnet.

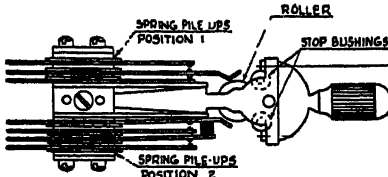

Lever switching key.

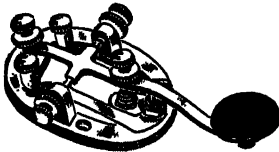

Transmitting key.

key 1. A hand-operated switching device ordinarily formed of concealed spring contacts with an exposed handle or pushbutton, capable of switching one or more parts of a circuit. 2. A special lever-type switch that can be operated rapidly by hand to form code signals by opening and closing a circuit in radio or wire telegraphy.

key click Those components of telegraphic radiation that are set up as transients by the opening or closing of the signaling key but are not essential for communication.

key-click filter A filter that attenuates the surges produced each time the keying circuit of a transmitter is opened or closed by the key.

keying chirps Sounds accompanying code signals when the transmitter is unstable and shifts slightly in frequency each time the sending key is closed.

keying wave The emission that takes place in telegraphic communication while the active portions of the code characters are being transmitted. Also called *marking wave*.

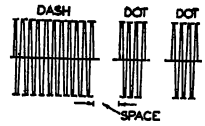

Keying produces the signals, such as the letter *D* above, in a continuous-wave transmitter.

key station The station at which a network radio or television program originates.

keystone-shaped Wider at the top than at the bottom, or vice versa.

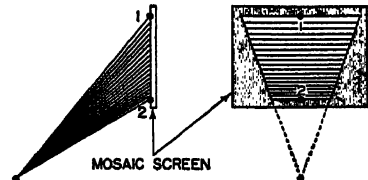

keystoning Producing a keystone-shaped scanning pattern due to the fact that the electron beam in the television camera tube is at an angle with the principal axis of the tube.

kg Abbreviation for kilogram.

kick Sudden movement of the pointer of an ohmmeter when connected to a capacitor of fairly large value. The amount of the kick is a rough measure of the size of the capacitor.

kilo- Metric prefix meaning 1,000.

kilocycle One thousand cycles. Abbreviated kc, and interpreted as meaning thousands of cycles per second.

kilogauss A unit of magnetic induction equal to 1,000 gaussess.

kilogram The practical metric standard of mass and weight. It is equal to 1,000 grams, or approximately 2.2 pounds. Abbreviated kg, usually without a period.

kilohm Abbreviation for kilo-ohm, equal to 1,000 ohms.

kilo-line A unit of magnetic flux equal to 1,000 centimeter-gram-second lines or maxwells.

kilometer One thousand meters, or approximately 3,280 feet.

kilometric waves British term for electromagnetic waves having wavelengths between 1,000 and 10,000 meters.

kilovar Alternative abbreviation for reactive kilovolt-ampere, a practical unit of reactive power equal to 1,000 reactive volt-amperes. The other abbreviation is kvar.

kilovar-hour A unit equal to 1,000 reactive volt-ampere-hours.

kilovolt A unit equal to 1,000 volts. Abbreviated kv.

kilovoltage A voltage of the order of thousands of volts, such as the voltage applied to an X-ray tube.

kilovolt-ampere A unit of apparent power, equal to 1,000 volt-amperes. Abbreviated kva.

kilovoltmeter A voltmeter designed to measure and read in thousands of volts.

kilowatt A unit of electric power equal to 1,000 watts, or 1.34 horsepower. Abbreviated kw.

kilowatt-hour A unit of electric energy, equal to 1,000 watt-hours or to an average of one kilowatt for a total time of one hour. Abbreviated kw hr.

kilowatt-hour meter An electricity meter that measures and registers electric energy in kilowatt-hours.

kinescope A cathode-ray tube for television receivers, having at its narrow end an electron gun that produces an electron beam, having at its large end a fluorescent screen, and having in between a set of electrostatic deflecting plates or electromagnetic deflecting coils that cause the electron beam to move across the screen and reproduce thereon an image of the scene originally televised. Originally a trade-mark for RCA tubes of this type.

kinetic energy Energy associated with motion.

kinetics That part of mechanics which deals with the effects of forces in changing the motions of bodies.

Kipp relay A two-stage untuned amplifier in which all the output voltage is fed back to the input circuit through direct-current coupling, with direct-current coupling also between the tubes. Its action is like that of a trigger circuit, in which only one tube conducts at a time, and the circuit will remain stable with either tube conducting. A voltage pulse of very short duration will cause switch-over from one tube to the other, and a pulse of opposite polarity will switch it back. Either plate current may be used as the output current of the relay.

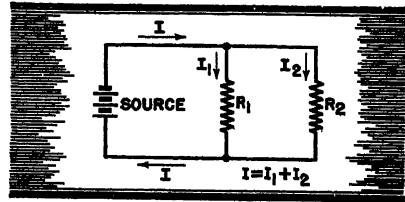

Kirchhoff's current law.

Kirchhoff's laws 1. The sum of the currents flowing to a given point in a circuit is equal to the sum of the currents flowing away from that point. 2. The algebraic sum of the voltage drops in any closed path in a circuit is equal to the algebraic sum of the electromotive forces in that path. Also called *laws of electric networks*. 3. Any of the other laws set forth by G. R. Kirchhoff, German physicist. One of these is: At a given temperature, the ratio of the emissive power of a body to its radiation-absorbing power is the same for all surfaces.

klystron A vacuum tube for converting direct-current energy into radio-frequency energy by alternately slowing down and speeding up an electron beam, utilizing the transit time between two points to produce a velocity-modulated electron stream that delivers radio-frequency power to a cavity resonator. The term is applicable to an ultrahigh-frequency amplifier or generator that combines the velocity-modulation principle with one or more cavity resonators to produce and/or utilize a velocity-modulated beam of electrons.

KLYSTRON CONTROL GRID

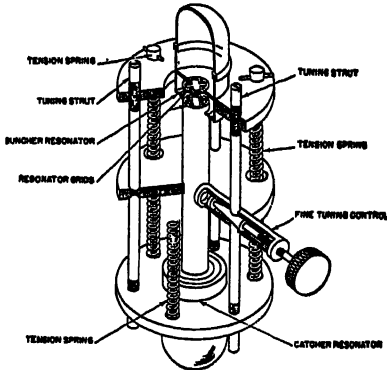

Klystron gang tuner, having three adjusting screws for varying the grid spacing and the angularity of the planes of the grids.

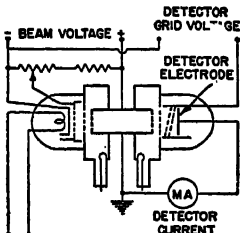

Klystron detector circuit.

klystron control grid The electrode in the electron gun which controls the emission or beam current of a klystron or other velocity-modulation tube.

klystron generator A klystron tube used as a generator, with its second cavity or catcher feeding waves directly into a wave guide.

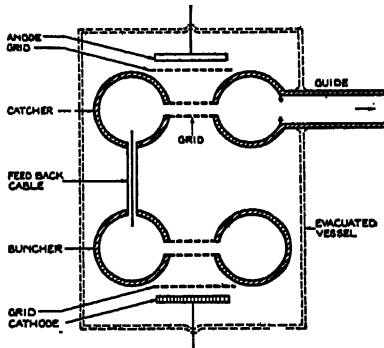

Klystron generator feeding waves directly into a guide from the catcher.

klystron oscillator An oscillator employing a klystron tube to generate considerable radio-frequency power.

klystron repeater A klystron tube operated as an amplifier and inserted directly in a wave guide in such a way that incoming waves velocity-modulate the electron stream emitted from a heated cathode. A second cavity converts the energy of the electron clusters into waves of the original type but of greatly increased amplitude and feeds them into the outgoing guide.

klystron tube A klystron.

km Abbreviation for kilometer.

knife switch A switch in which one or more flat metal blades, pivoted at one end and having an insulating handle at the other, are so mounted that they can be inserted between spring contacts to complete a circuit.

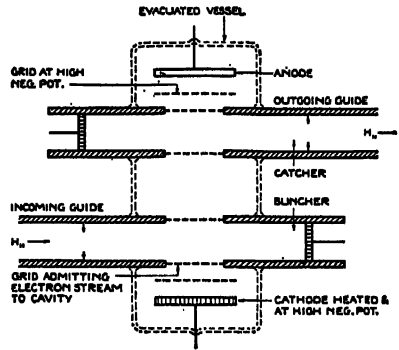

Klystron tube adapted for operation as a repeater in a wave guide, to build up the energy of a wave passing through the guide.

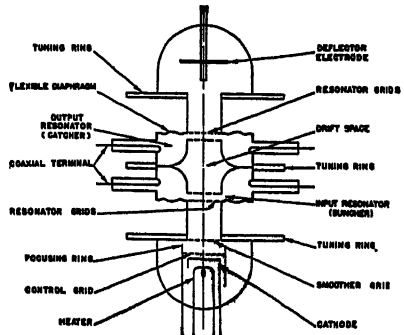

Generalized cross-sectional diagram of a klystron amplifier, with all electrodes and elements identified.

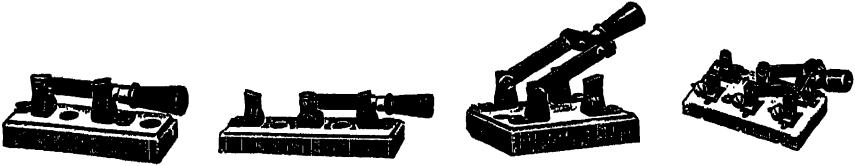

Knife switches. Left to right: single-pole, single-throw; single-pole, double-throw; double-pole, single-throw; double-pole, double-throw.

knob 1. An object attached to the end of the control shaft of a device to make it easier to change the position of the shaft by hand. The knob sometimes has a pointer or other position-indicating means. 2. A one- or two-piece insulator used to support wires at a definite spacing from a surface. It has a central hole for a mounting nail or screw, and one or more grooves for wire.

knob-and-tube wiring Power wiring installed by means of insulated single wires supported by porcelain knobs or run through ceramic tubes inserted in holes drilled through the framework timbers of a building. Largely superseded today by BX cable, in which the insulated wires are protected by a flexible spiral metal sheath.

knockout A portion of the wall of a box or cabinet, so fashioned that it may be removed readily by a hammer blow in order to provide a hole through which wires can be run or to which conduit or cable can be attached.

Knudsen gage A gage for measuring extremely low gas pressures, dependent

on unequal bombardment of opposite surfaces of a vane by molecules of different energies. This gives a measurable resulting force that is proportional to gas pressure.

Koch resistance A high resistance consisting essentially of an illuminated phototube operated at a voltage low enough to ensure that the resistance is independent of voltage.

kv Abbreviation for kilovolt.

kva Abbreviation for kilovolt-ampere.

kvar Abbreviation for reactive kilovolt-ampere.

kw Abbreviation for kilowatt.

kwhr Abbreviation for kilowatt-hour.

kymograph An instrument for recording wavelike oscillations or varying quantities for medical studies, consisting of a revolving drum or moving strip of paper on which a stylus records muscular contractions, respiratory movements, pulse waves, etc. Called an *electrokymograph* when it incorporates electric or electronic devices.

L

L 1. Letter used on diagrams to designate a coil or a winding of a transformer. 2. Abbreviation for lambert. 3. Roman numeral for 50.

L Letter used in equations to specify an inductance value in henrys.

l Abbreviation commonly used for (1) lumen, (2) liter, (3) length.

labile oscillator A local oscillator whose frequency is controlled at all times by a signal received from some remote point by radio or over wires.

labyrinth speaker A loudspeaker mounted in an acoustic baffle having air chambers so designed as to prevent acoustic standing waves.

lacquer disk A phonograph record having a surface coating of a lacquer compound that often contains cellulose nitrate, applied over a base of metal, glass, or paper. Used both for instantaneous recordings and for masters from which commercial phonograph records are eventually made.

ladder attenuator A series of symmetrical sections designed so that the required ratio of the voltage loss per section is obtained with image-impedance operation. The impedance between any junction point in a ladder attenuator and the common ground side of the system is half the image impedance. Used in signal generators and other devices requiring that voltages and currents be reduced in known ratios.

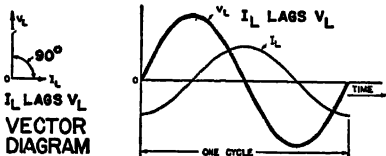

Current lags voltage by 90 degrees in a coil.

lag 1. A delay in the action of any device, such as lag of a thermometer behind changes in temperature. 2. For two alternating quantities having the same frequency, the one that reaches a particular point in a cycle last is said to lag the other.

lagging current The current flowing in an inductive circuit. If the circuit contains only inductance, the current lags 90 degrees behind the applied voltage. The characteristics of an inductance cause current changes to occur a short interval of time after corresponding voltage changes.

lagging load A load that is predominantly inductive, so that the load current lags behind the load voltage. Also called *inductive load*.

Lagrangian function A mathematical expression involving kinetic energy of particles.

lambda Greek letter λ , generally used to designate wavelength in meters.

lambert A unit of brightness equal to $1/\pi$ candle per square centimeter. It is equal to the uniform brightness of a perfectly diffusing surface emitting or reflecting light at the rate of one lumen per square centimeter.

laminated Built up from a number of sheets or laminations.

laminated contact A switch contact made up of a number of laminations, each making individual contact with the opposite conducting surface.

laminated core An iron core for a coil, transformer, armature, etc., built up from laminations stamped from sheet iron or steel. The laminations are more or less insulated from each other by surface oxides and sometimes also by application of varnish. Laminated construction is used to minimize the effect of eddy currents.

lamination A single stamping of sheet material, used in building up a laminated object such as the core of a power transformer.

Lamont's law The permeability of steel at any flux density is proportional to the difference between the saturation value of the flux density and its value at the point in question. This law is only approximately accurate and is not true for the initial part of the magnetization curve.

lamp A general term for an artificial source of light.

lamp bank An arrangement of a number of incandescent lamps, commonly used as a resistance load during electrical tests.

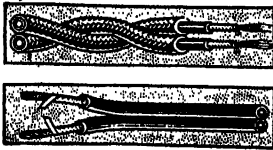

Twisted cotton-covered and parallel rubber-covered lamp cord.

lamp cord A twin conductor, either twisted or parallel, in a size frequently used for connecting floor lamps and other portable electric appliances to wall outlets.

lamp receptacle A device intended to support an electric lamp mechanically and connect it electrically to power-line wires. Also called *socket* or *lampholder*.

lampholder A lamp socket.

land The record surface between two adjacent grooves.

landing beacon A radio transmitter that produces a landing beam for aircraft.

landing beam A highly directive radio signal, projected along a line slanting upward from the landing surface of an airport for use as a guide for aircraft landing under conditions of poor visibility.

land line A telegraph or telephone line passing over land, as opposed to submarine cables.

land station A station not capable of being moved, as differentiated from a mobile station.

Langevin ion An electrified particle in a gas, resulting from accumulation of ions on dust particles or other nuclei.

Langmuir dark space A nonluminous region surrounding a negatively charged probe inserted into the positive column of a glow or arc discharge.

L antenna An antenna that consists of an elevated horizontal wire having a vertical down-lead connected at one end.

lapel microphone A small microphone having a clip that permits attachment to a lapel or breast pocket of a coat. Used chiefly by speakers in auditoriums, to permit free movement around the stage while speaking.

Laplace's equation At any point in an isotropic medium, which has no electric charges, the divergence of the electric displacement is zero. One important use is in calculating potentials at various points in the electron lenses used in cathode-ray tubes and in the electron microscope.

Laplace's law The strength of the magnetic field at a given point due to any element of a current-carrying conductor is directly proportional to the strength of the current and the projected length of the element, and is inversely proportional to the square of the distance of the element from the point in question.

Laplace's operator The differential operator that occurs in Laplace's and Poisson's equations. It is often represented by the symbol ∇^2 .

lapping Bringing quartz crystal plates to final frequency by a precision grinding process involving movement with uniform pressure over a flat plate on which has been poured a liquid abrasive mixture.

lap winding An armature winding in which opposite ends of each coil are connected to adjoining segments of the commutator. The windings thus overlap.

LARMOR PRECESSION FREQUENCY

Larmor precession frequency A value equal to one-half the gyro frequency of ions rotating around the lines of the magnetic field of the earth.

laryngaphone A microphone applied to the throat of a speaker to pick up voice vibrations directly. Valuable in noisy locations because it does not respond to extraneous sound waves.

lat Abbreviation for latitude.

lateral motion Motion in a sidewise direction.

lateral recording A recording in which the groove modulation is in the plane of the record, so that the phonograph needle moves from side to side during playback. The depth of the groove is essentially constant.

lateral reproducer A phonograph pickup designed for lateral-cut phonograph records, in which the groove depth is constant but the groove runs from side to side. All commercial recordings and home phonograph pickups use the lateral-recording system.

latitude Distance north or south of the equator, measured in degrees, minutes, and seconds starting from 0 degrees at the equator and ending with 90 degrees at either pole.

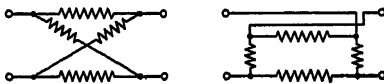

Lattice network, drawn in two ways.

lattice network A network composed of four impedance branches connected in series to form a closed circuit, with two nonadjacent junction points serving as input terminals and the remaining two junction points serving as output terminals.

lattice-wound coil A coil wound in a crisscross manner to reduce distributed capacitance. Also called *honeycomb coil*.

Laue pattern The photographic record obtained when X rays from a pinhole or slit are sent through a single crystal that diffracts or bends the rays in all directions.

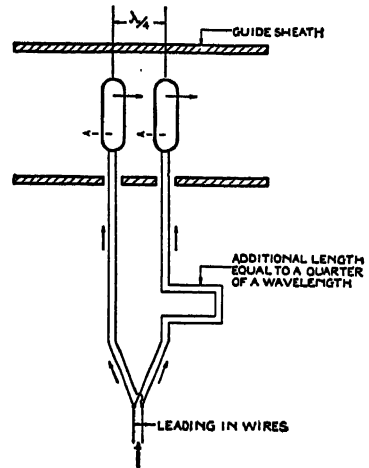

Launching device for feeding waves into or picking waves out of a wave guide in one direction only without the use of a reflecting piston. Similar antennas spaced one-quarter wavelength apart in the guide are fed by leads differing a quarter wavelength in length so that two waves enhancing one another are launched forward (solid arrows) and two waves neutralising each other are launched backward (dotted arrows).

launching The process of transferring energy from a coaxial cable or shielded paired cable into a wave guide. It is similar to the process of radiating energy from an antenna into free space except that here the space is restricted to the interior of the guide.

law for heating effect of current The rate at which heat is produced in an electric circuit having constant resistance is proportional to the square of the current. Often called *Joule's law*.

law of electric charges Like charges repel; unlike charges attract.

law of electromagnetic induction The electromotive force induced in a circuit by changes in the flux linkages of the circuit is proportional to the rate at which the flux linkages are changing. Often called *Faraday's law*, though not proposed by him.

law of electromagnetic systems 1. Any two circuits carrying current tend to dispose themselves in such a way that the flux of magnetic induction linking the two will be a maximum. 2. Every

electromagnetic system tends to change its configuration so that the flux of magnetic induction will be a maximum. Relays utilize this principle.

law of electrostatic attraction The attraction or repulsion between two electric charges is proportional to the product of their magnitudes and is inversely proportional to the square of the distance between them. The force between unlike charges is an attraction; the force between like charges is a repulsion. Also called *Coulomb's law*.

law of induced current The current induced in a circuit as a result of its motion in a magnetic field is in such a direction as to exert a mechanical force opposing the motion. Often called *Lenz's law*.

law of lenses For an optical lens having a focal length f , with P being the distance from the lens to the object and Q being the distance from the lens to the image, the following relation exists:

$$\frac{1}{P} + \frac{1}{Q} = \frac{1}{f}$$

law of magnetism Like poles repel; unlike poles attract.

laws of electric networks 1. The sum of the currents flowing to a given point in a circuit is equal to the sum of the currents flowing away from that point. 2. The algebraic sum of the voltage drops in any closed path in a circuit is equal to the algebraic sum of the electromotive forces in that path. Usually called *Kirchhoff's laws*.

layer winding A coil-winding method in which adjacent turns are laid evenly side by side along the length of the coil form. Any number of additional layers may be wound over the first, usually with sheets of insulating material between the layers.

layout A diagram indicating the positions of various parts on a chassis or panel.

lb Abbreviation for pound.

lb per cu ft Abbreviation for pounds per cubic foot.

LC product Inductance L in henrys multiplied by capacitance C in farads.

LC ratio The ratio of L to C ; equal to inductance in henrys divided by capacitance in farads.

lead Pronounced "led." A soft gray metal widely used in storage-battery construction, as a component of solder, for shielding cables, etc.

lead 1. Pronounced "leed." A connecting wire, such as a test lead, battery lead, etc. 2. For two alternating quantities having the same frequencies, the one that reaches a particular point in a cycle first is said to lead the other.

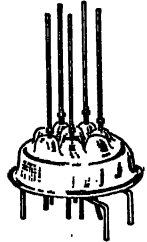

Leads in molded-glass stem assembly for a transmitting tube.

lead-acid cell The cell in an ordinary storage battery, in which the electrodes are grids of lead containing an active material consisting of certain lead oxides that change in composition during charging and discharging. The electrodes or plates are immersed in an electrolyte of dilute sulphuric acid. Also called *lead cell*.

lead cell A lead-acid cell.

lead-covered cable A cable whose conductors are protected from moisture and mechanical damage by a sheath of lead.

lead-in That portion of an antenna system which connects the overhead antenna wire to the input of a receiver or to the disconnecting switches or instruments of a transmitter or its tuning house.

leading current A current that reaches its maximum value before the voltage that produces it. A leading current flows in any circuit that is predominantly capacitive.

leading load A load that is predominantly capacitive, so that its current leads the voltage applied to the load.

LEAD-IN INSULATOR

lead-in insulator Generally, an insulator inserted in a hole drilled through an outer wall, through which the lead-in wire can be brought into a building.



Lead-in insulator

lead-in spiral A blank spiral groove at the beginning of a record, generally having a much greater pitch than that of the recorded grooves, provided to bring the pickup quickly to the first recorded groove regardless of where it is dropped in the outer margin by an automatic record changer.

lead screw Pronounced "lead." The threaded rod that guides the cutter at a uniform rate across the surface of an ungrooved disk during recording, so that the grooves will be uniformly spaced.

leakage Gradual entry, escape, or wandering off of a quantity contrary to what is intended, such as magnetic leakage or current leakage.

leakage current 1. Undesirable flow of current through or over the surface of an insulating material or insulator. 2. The flow of direct current through a capacitor. 3. The alternating current that passes through a rectifier without being rectified. 4. The current that flows between two or more electrodes of a tube by any path other than across the vacuous space between the electrodes.

leakage flux Magnetic lines of force that do not encircle all the turns in a coil or transformer and hence do not contribute to inductance or to the transfer of energy from one coil to another.

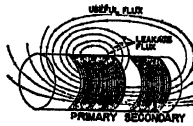

Leakage flux.

leakage resistance The resistance of the path over which leakage current flows. It is normally a high value.

leakance The reciprocal of insulation resistance. For a transmission line, it is the reciprocal of the resistance in

ohms between the two conductors through their insulation.

leaky A condition in which the resistance has dropped so much below its normal value that excessive leakage current flows. Usually applied to a capacitor.

Lecher oscillator A device for producing a system of standing waves in two parallel wires called Lecher wires.

Lecher wires Two parallel wires that are connected to the output of a radio-frequency source and used mainly to measure wavelength.

Leclanche cell A primary cell having a carbon positive electrode and a zinc negative electrode in an electrolyte of sal ammoniac and a depolarizer. This is the common dry cell.

Leduc current An interrupted direct current, each pulse of which has approximately the same duration and current strength. Used in electrobiology to produce anesthesia and for other purposes.

left-hand elliptically polarized wave An elliptically polarized wave in which the rotation of the direction of displacement is counterclockwise to an observer looking in the direction the wave is traveling.

left-hand rule 1. For motors and generators: if the thumb, first, and second fingers of the left hand are stretched out at right angles to one another, with the thumb representing the direction of motion, the first finger representing the direction of magnetic lines of force, and the second finger representing the direction of electron flow (not conventional current flow), the relations between the directions will then be correct for a conductor in the armature of a generator.



Left-hand rule for determining direction of magnetic lines of force around a single current-carrying wire.

For a motor, the right hand is used. 2. For a current-carrying wire: if the fingers of the left hand are placed around the wire in such a way that the thumb points in the direction of electron flow, the fingers will be pointing in the direction of the magnetic field. For conventional current flow (the opposite of electron flow), the right hand is used.

left-hand taper In a rheostat or potentiometer, the condition in which there is greater resistance in the counterclockwise half of the operating range of the control (looking from the shaft end) than in the clockwise half.

legend Any table of symbols or other data placed on a map, chart, or diagram to assist in proper interpretation. It does not include the title.

Lenard rays Cathode rays that emerge from a special vacuum tube through a thin glass window or thin metallic foil.

Lenard tube A discharge tube having a thin window at the end opposite the cathode, through which cathode rays can pass into the atmosphere. Used in radiology, where it is also called *cathode-ray tube*.

length of scanning line The length of the path traced by the scanning or recording spot in moving from a point on one line to a corresponding point on the next following line in a facsimile system.

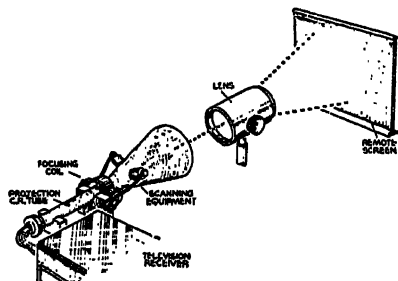

Use of lens with projection cathode-ray tube.

lens A device employed to change the directions of the beams passing through it in a particular desired manner. An optical lens employs curved surfaces of a transparent material such as glass to act upon beams or rays of light,

while an electron lens employs either electric or magnetic fields acting on electron beams.

lens disk A television scanning disk having a number of openings arranged in the form of a spiral, with a lens set into each opening.

lens speed A lens rating equal to focal length divided by diameter, determining the amount of light a lens will pass.

Lenz's law The current induced in a circuit as a result of its motion in a magnetic field is in such a direction as to exert a mechanical force opposing the motion. Also called *law of induced current*.

Lepl discharge A quenched spark gap used in early radiotelegraph transmitters employing shock excitation.

level The value of a variable quantity, particularly when specified in decibels as is customary in connection with audio-frequency signal strength or the strength of sound waves.

level indicator A volume indicator.

Lewis-Langmuir atom A theory that electrons outside the nucleus of an atom occupy fixed relative positions, in contrast to the orbital electrons in the Bohr atom.

Leyden jar The original electric capacitor, consisting of metal foil sheets on the inside and outside of a glass jar that served as the dielectric. Developed in Leyden in 1745.

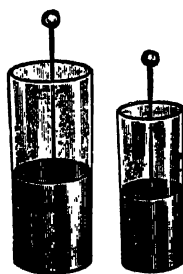

Leyden jars.

l-f Abbreviation for low-frequency, a Federal Communications Commission designation for the band from 30 to 300 kilocycles in the radio spectrum. Same abbreviation used for noun as for adjective.

Lichtenberg figure A pattern traced on a dielectric surface that has been non-

LIE DETECTOR

uniformly electrified, by sifting over it fine powders such as a mixture of sulphur and red lead.

lie detector An instrument that indicates or records one or more functional variables of a body, such as blood pressure, heart action, or skin resistance, during questioning, to determine when the person is not telling the truth. Skin resistance drops when a person is lying. Technically known as *psycho-integroammeter*.

life test Operation of a device under such a combination of time and conditions as to approximate a normal lifetime of use, in order to observe whether changes occur in actual service and to secure an approximate measure of life expectancy.

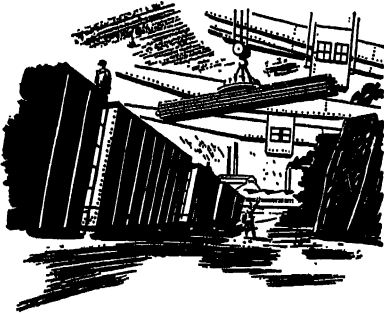

Lifting magnets like this require direct current, often obtained from electronic rectifiers.

lifting magnet A powerful electromagnet used instead of a hook on a crane, to lift iron and steel objects by magnetic attraction and release them when the magnetizing current is cut off.

light That radiant energy which, by its action on the organs of vision, enables them to perform their function of sight. The radiant energy that is like luminous energy but does not appreciably affect the average normal retina is sometimes called light (ultraviolet light or infrared light). Modern theory considers light as quanta of energy that move as if guided by waves. Newtonian theory considered light as material particles or corpuscles sent off in all directions from a luminous body; this theory has long been abandoned. Wave theory considers light

as being transmitted from a luminous body by an undulatory or vibrational movement having a velocity of about 186,300 miles per second, with the vibrations of the ether being at right angles to the direction of travel. The wavelengths vary from 3.85 ten-thousandths of a millimeter for violet to 7.6 ten-thousandths of a millimeter for red. The electromagnetic theory of light, originated by Maxwell, states that these visible infrared and ultraviolet waves are the same in kind as radio waves, and that light is therefore an electromagnetic phenomenon.

light chopper A mechanical device for interrupting a light beam, usually for the purpose of permitting amplification of the output of a phototube on which the beam is directed.

lighthouse tube A popular designation for an electronic tube having its electrodes arranged in parallel planes or layers, with glass and metal fused together as a rigid unit capable of withstanding the severe jolts encountered in military applications. The coplanar electrode design gives very low interelectrode capacitance along with high power output at extremely high frequencies. The generic term for tubes of this type is megatron. Also called *disk-seal tube*.

light load A load that is only a small proportion of that which the device is designed to handle.

light modulation In facsimile, the method of introducing the carrier signal by periodic variation of the scanner light beam while the average amplitude of this beam is being varied by the density changes of the subject copy.

light-negative Having negative photoconductivity, hence decreasing in conductivity (increasing in resistance) under the action of light. Selenium sometimes exhibits this property.

lightning An electric discharge occurring in the atmosphere. One terminal is a cloud, and the other terminal may be another cloud, the earth, or some object on the earth.

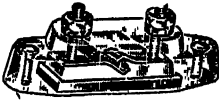

Lightning arrester.

lightning arrester A protective device used to provide a path directly to ground for lightning discharges that strike an antenna or other conductor. The arrester must reduce the voltage of a surge applied to its terminals, must interrupt the following current (arcing) if present, and must restore itself automatically to its original operating condition.

lightning generator Popular name for a surge generator or impulse generator used to produce high-voltage surges for testing insulators and for other purposes.

lightning rod A rod projecting above the highest point on a structure and connected to ground in such a way that it can carry a lightning discharge to ground.

lightning surge A transient electric disturbance produced in an electric circuit by lightning.

lightning switch A switch provided to connect a radio antenna to ground during lightning storms.

light-positive Having positive photoconductivity, hence increasing in conductivity (decreasing in resistance) under the action of light. Selenium ordinarily has this property.

light quantum According to modern theory, both invisible and visible light consist of quanta of energy that move as if guided by waves.

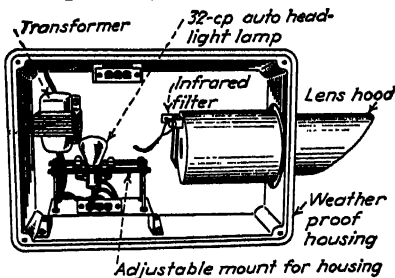

Light source for photoelectric burglar alarm system.

light ray A beam of light having a small cross-section.

light relay A photoelectric device that closes a relay in response to a change in the intensity of a beam of light.

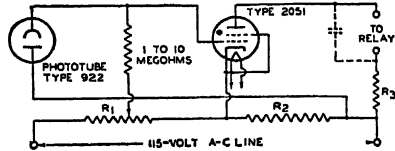

Typical light-operated relay circuit.

light-sensitive Exhibiting a photoelectric effect when irradiated, such as photoelectric emission, photoconductivity, or photovoltaic action. Also called *photosensitive*.

light-sensitive cell A cell that changes its electric characteristics with illumination. Examples are photovoltaic cells and photoconductive cells.

light-sensitive tube A vacuum tube that changes its electrical characteristics with illumination. Usually called *phototube*.

light valve 1. A device whose transparency to light can be made to vary in accordance with variations in an externally applied quantity such as a voltage, current, electric field, magnetic field, or electron beam. In earlier forms used in mechanical television systems, the total transparency was varied and a mechanical scanning disk was employed to make the transmitted light fall on the correct elemental area of the reproduced image at each instant. The Kerr cell is an example of this type. In the modern suspension light valve, however, the light transparency is varied from point to point by means of a scanning electron beam, so that a light beam projected through the valve will produce on the viewing screen the complete received image without employing moving mechanical parts in the television receiver. 2. A mechanical device that regulates the amount of light reaching a sensitized surface such as the cathode of a phototube or the sound-track portion of the film in a motion-picture camera.

LILIENFELD TUBE

Lilienfeld tube A type of X-ray tube having a heated filament that forms the cathode of an auxiliary circuit and projects electrons through a hollow working cathode connected to the main high-voltage circuit.

limit bridge A form of Wheatstone bridge used for rapid routine tests of the resistance of manufactured products. No attempt is made to secure balance for each test; instead, all products that produce deflections within certain limits corresponding to permissible tolerance are passed.

limiter That section of a frequency-modulated receiver which follows the intermediate-frequency amplifier and removes amplitude variations from the frequency-modulated signal by cutting off all signal peaks exceeding a certain amplitude. It is this stage that limits interfering noises.

limiting The removal, by electronic means, of one or both extremities of a waveform at a predetermined level.

limit switch A device designed to cut off power automatically at or near the limit of travel of any moving object actuated by electric means.

Lindemann glass A lithium borate-beryllium oxide glass having no element higher in atomic number than oxygen, used as window material for low-voltage X-ray tubes because it will pass X rays of extremely long wavelength, such as Grenz rays.



Assembly line in factory making electronic equipment.

line 1. A transmission line or power line. 2. A production line used in mass-production assembly of electronic equipment.

linear A relation such that any change in one of the related quantities is

accompanied by an exactly proportional change in the other.

linear amplification Vacuum-tube amplification in which changes in plate current are directly proportional to changes in the applied grid voltage.

linear control A rheostat or potentiometer having uniform distribution of resistance along the entire length of its resistance element.

linear detection That form of detection in which the output voltage is substantially proportional to the carrier voltage throughout the useful range of the detecting device.

linear distortion Distortion that is not dependent on the amplitude of the voltage or current involved.

linear modulation Modulation in which the amplitude of the modulation envelope (or the deviation from the resting frequency) is directly proportional to the amplitude of the sound wave at all audio frequencies.

linear rectification Rectification in which the rectified current or voltage is proportional to the amplitude of the input wave over a wide range of input amplitudes.

linear rectifier A rectifier whose output current or voltage contains a wave having a form identical with that of the envelope of an impressed signal wave.

linearity control A control provided in electronic television systems to adjust the shapes of scanning waves. In a receiver they are usually semiadjustable controls inside the set. There may be top, bottom, right, and left linearity controls.

linearly polarized wave A transverse wave in which the displacement has a constant direction at a point in space.

line-balance converter A device installed at the end of a coaxial transmission line to isolate the outer conductor from ground. Also called *bazooka*.

line cord A two-wire cord terminating in a two-prong plug at one end and

LINE-STABILIZED OSCILLATOR

connected permanently to a radio receiver or other appliance at the other end, used to make connections to a source of power.

line-cord resistor An asbestos-enclosed wire-wound resistance element incorporated in a line cord along with the two regular wires. The resistance serves to lower the line voltage to the correct value for the series-connected tube filaments and pilot lamps of a universal a-c/d-c receiver.

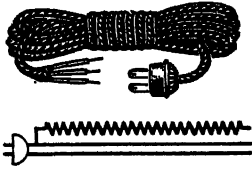

Line-cord resistor and symbol.

line drop The voltage drop existing between two points on a power line or transmission line, due to the resistance, reactance, or leakage of the line.

line equalizer Inductance and/or capacitance inserted in a transmission line to correct the frequency-response characteristics of the line.

line filter A device inserted between a receiver or other appliance and the power line to prevent passage of noise signals. It contains one or more inductors and capacitors. It is used with a radio receiver to prevent power-line noise signals from entering the receiver, and is used with other appliances to prevent their own electrical noises from entering the power line.

line flyback In a television system, the right-to-left return motion from the end of one scanning line to the beginning of the next. Also called *horizontal flyback* or *horizontal retrace*.

line frequency The number of scanning lines traced in one second in rectilinear scanning.

line integral The line integral between points on a given straight or curved line in the region occupied by a vector field is the definite integral of the product of a line element by that com-

ponent of the vector which is tangent to that element. Thus, the electromotive force along a line connecting two points in a magnetic field is the line integral of the magnetic intensity.

line level The signal level in decibels at a particular position on a transmission line.

line loss The total of the various energy losses occurring in a transmission line.

line microphone A microphone consisting of a large number of small tubes of different lengths, with one end of each abutting a microphone and the other ends equally spaced along a line so as to give highly directional characteristics. Popularly known as *machine-gun mike*.

line noise Disturbing noise originating in a transmission line due to various causes, such as poor contacts in the line or inductive interference from power lines.

line of a vector A straight or curved line such that, at each point of its path in a vector field, the vector at that point is tangent to the line. Lines of magnetic induction are examples.

line of force An imaginary line in an electric or magnetic field, coinciding in direction with the field intensity at each point. It was conceived by Faraday, and is used for convenience in the study of magnetic and electric fields. When used as a unit of magnetic flux, a line of force is sometimes called a maxwell.

line of propagation In respect to a wave traveling from one point to another, the line of propagation is the path or line of travel extending between the two points and having at all points in space the direction of the wave normal (perpendicular) at those points.

line relay A relay that controls an indicating lamp on the switchboard of a telephone exchange.

line-stabilized oscillator An oscillator in which a section of transmission line

LINE SYNCHRONIZING IMPULSE

is used as a sharply selective circuit element for the purpose of controlling the frequency.

line synchronizing impulse In television, the impulse added to the video signal at the end of each scanning line for receiver-synchronizing purposes.

line voltage The voltage provided by a power line. In the United States, it is usually between 115 and 120 volts at convenience outlets in homes.

line-voltage regulator A device that counteracts variations in power-line voltage, and delivers an essentially constant voltage to the connected load. A ballast tube is sometimes used for this purpose in radio receivers.

link 1. The fusible and replaceable part used in some types of cartridge fuses. **2.** A link circuit. **3.** A flat strip serving as a removable connector between two terminal screws.

linkage 1. A measure of the interlocking of magnetic flux with an electric circuit. It is the product of the flux by the number of turns linked by the flux, and is a measure of the voltage that will be induced in the circuit. **2.** A mechanical linkage is an arrangement of solid pieces connected by movable joints, used to transfer motion in a desired manner.

link circuit A closed loop used for coupling purposes. It generally consists of two coils, each having a few turns of wire, connected by a twisted pair of wires or by other means, with each coil placed over, near, or in one of the two coils that are to be coupled.

link coupling Use of a link circuit to provide coupling between the coils of separate circuits.

lip microphone A type of carbon microphone worn on the upper lip of a person and having an acoustic balancing arrangement that cancels sounds originating at a distance from the microphone. It is used where noise level is extremely high, as in military tanks. Sound waves from the person's lips enter through only



Lip microphone in use.

one aperture and act on the microphone, whereas sound waves from a distance enter through both apertures and act on opposite sides of the diaphragm simultaneously so that their effects cancel.

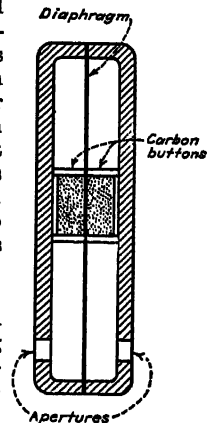

Cross-section of lip microphone.

liquid rheostat A rheostat consisting of metal plates immersed in a conducting liquid. The resistance is changed by varying the area of the plates in contact with the liquid, either by raising and lowering the plates or by altering the liquid level with a pump or otherwise.

Lissajous curves A family of plane curves described by a point having two simple harmonic motions at right angles. Different curves are obtained by varying the relations between amplitude, frequency, and phase of the two motions. Widely used for frequency comparison by means of cathode-ray oscilloscopes.

Lissajous figures Lissajous curves.

LOCAL PROGRAM

listener echo Echo that reaches the ear of the listener in a radio or telephone communication system.

liter The volume of one kilogram of pure water at its maximum density, occurring at 4° centigrade. One liter is equal to 1,000.027 cubic centimeters.

lithium An alkali metal having characteristics similar to those of sodium, sometimes used on the cathodes of phototubes because it gives high response at the extreme violet end of the light spectrum.

litz wire Wire made up from a number of fine separately insulated strands woven together in such a way that each strand successively takes up all possible positions in the cross-section of the entire conductor. It gives reduced skin effect and hence lower resistance to high-frequency currents. The full name is litzendraht wire.

live A term applied to a circuit that is connected to a voltage source.

live end That end of a radio studio which gives the greater reflection of sound.

liven the studio To remove sound-absorbing material from a radio studio so as to expose sound-reflecting surfaces of walls, windows, and floors.

ln Abbreviation for natural logarithm.

L network A network composed of two impedance branches in series, the free ends of the network being connected to one pair of terminals, and the junction point and one free end being connected to another pair of terminals.

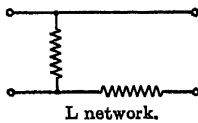

load 1. The power that a machine or apparatus delivers. In the case of an alternating-current machine, it is the product of the effective output current and the effective output voltage. 2. That device which is intentionally placed in a circuit or connected to a machine or apparatus to absorb power and convert it into the desired useful form.

load curve A curve of power versus time, showing the amount of power drawn by a load at each instant during the period covered.

loaded antenna An antenna provided with extra inductance, in order to increase its electrical length.

loaded line A line to which loading has been applied, either by series loading or by shunt loading.

loading Alteration of the reactance of a line or device for the purpose of improving its transmission characteristics throughout a given frequency band.

loading coil 1. An iron-core coil connected into a telephone line or cable at regular intervals to lessen the effect of its capacitance and to reduce distortion. 2. A coil inserted in series with a radio antenna to increase its electrical length.

load line A straight line drawn across a series of plate current-plate voltage characteristic curves on a graph to show how plate current will change with grid voltage when a specified plate load resistance is used. The slope of the load line is made proportional to the reciprocal of the plate load impedance in ohms.

lobe One of the loops in the radiation pattern of a directional antenna.

local action The loss of otherwise usable chemical energy in a battery by currents that flow internally regardless of external connections.

local channel A standard broadcast channel in which several stations may operate with powers not in excess of 250 watts. The primary service area of a station operating on any such channel may be limited, as a consequence of interference, to a given field-intensity contour.

local oscillator The oscillator in a superheterodyne receiver. It may have a separate vacuum tube or utilize a part of the mixer-first detector tube.

local program A program originating at and released through only one broadcast station.

LOCKED GROOVE

locked groove A blank endless groove placed inside the record grooves on a phonograph record to prevent further travel of the phonograph needle after it reaches the end of the record. On most modern phonograph records, this groove is off center and provides an in-and-out motion for actuating the tripping mechanism of an automatic record changer.

locking relay A relay that renders some other relay or device inoperative under predetermined conditions.

loctal Alternative spelling of loktal.

lodestone A mineral consisting chiefly of a magnetic oxide of iron that is found in its natural state in a magnetized condition. Also called *magnetite*.

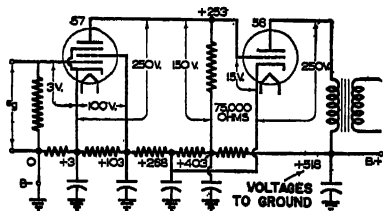

Loftin-White amplifier circuit.

Loftin-White circuit An early radio receiver circuit.

log 1. Abbreviation for common logarithm. 2. A list of radio stations with their frequencies, power, location, and other data. 3. A record of the stations with which a radio station has been in communication. Amateur radio operators as well as all commercial operators are required by law to keep this log. 4. At a broadcast station, a detailed record of the program broadcast by the station at all times. 5. At a broadcast transmitter, a record of the meter readings and other measurements that are required by law to be taken at regular intervals.

\log^{-1} Symbol for antilogarithm, read "the number whose logarithm is."

\log_{10} Symbol for the logarithm of a number to the base 10, which is the common system of logarithms. When-

ever the abbreviation log appears alone (without 10), the base 10 is implied.

log_e Symbol for the logarithm of a number to the base 2.718, designated as ϵ or e , used in the natural system of logarithms.

logarithmic curve A curve in which one coordinate of any point on it varies in accordance with the logarithm of the other coordinate. The equation for the curve is of the form $y = k \log x$ where k is a constant.

logarithmic decrement 1. The natural logarithm of the ratio of the amplitude of one oscillation to that of the next when no external forces are applied to maintain the oscillation. 2. A constant of a simple resonant circuit, equal to π times the product of the resistance and the square root of the ratio of the capacitance to the inductance.

logarithmic horn A horn whose diameter varies with length according to a logarithmic law.

logarithmic scale A linear scale for graphs, on which distances from the zero of the scale are proportional to the logarithms of the numbers with which these points on the scale are labeled.

logging Making a written record of essential data, such as the dial setting at which a radio station is received and meter readings required by law.

loktal base A special base for small vacuum tubes, so designed that it locks the tube firmly in a corresponding special eight-pin loktal socket. The tube pins are sealed directly into the glass envelope. Also spelled loctal.

loktal tube A vacuum tube having a loktal base.

long Abbreviation for longitude.

longitude Distance east or west of a meridian passing through Greenwich, England, measured in degrees, minutes, and seconds starting with zero degrees at Greenwich and ending with

LOOSE COUPLING

180 degrees at a point halfway around the world.

longitudinal wave A wave in which the direction of displacement at each point of the medium is the same as the direction of propagation.

long-pull magnet An electromagnet having a conical plunger moving in a hollow core, or otherwise designed so that it can exert practically uniform pull over a considerable range of movement of its armature.

long shunt Connecting a shunt field across both the series field and the armature, instead of directly across the armature of a motor or generator.

long-wave diathermy The use of frequencies in the range of about 1 to 3 megacycles to produce internal or surface heating of a person for medical treatment.

long waves Wavelengths longer than about 1,000 meters, corresponding to frequencies from about 300 kilocycles down to the highest audio frequencies.

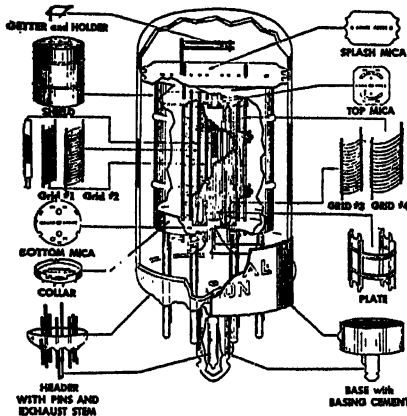

Exploded view of a lokaht tube, with important parts shown individually.

long-wire antenna An antenna whose length is an integral multiple of a half-wavelength. Also called *harmonic antenna*.

loom Flexible nonmetallic tubing used to protect insulated wire.

loop 1. A closed circuit. **2.** A graph having the form of a closed curve, such as a hysteresis loop. **3.** An antinode (a point of maximum amplitude in a standing wave).

loop antenna An antenna consisting essentially of one or more complete turns of wire. Used extensively in radio direction-finding apparatus, and often built into the cabinets of radio receivers. Loop antennas are usually tuned to resonance by a variable capacitor.

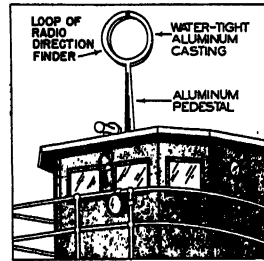
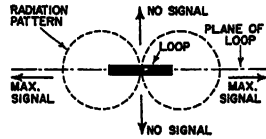

Radio direction-finder loop installation above the wheelhouse of a vessel, and loop characteristics.

loop test A method of locating a fault in a long conductor, as a telephone or telegraph line, by connecting that conductor to good conductors so as to form a closed circuit or loop in which measurements can be made to determine the position of the fault.

loose coupler An arrangement of two coils such that coupling can be varied over a wide range, usually by sliding one coil over the other.

loose coupling A small amount of coupling between two coils or circuits; less than critical coupling and providing little transfer of energy between circuits.

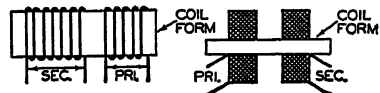

Examples of coupling.

LOSS

loss Energy that is dissipated without accomplishing useful work.

losser circuit A resonant circuit having sufficient high-frequency resistance to prevent sustained oscillation at the resonant frequency.

losses The combined values of power dissipated in a system without performing useful work.

A coil having losses



is equivalent to

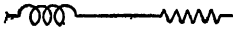

Losses make a coil equivalent to a pure inductance in series with a resistance having the same losses as the coil.

lossless line A theoretically perfect line that has no loss, and hence transmits all the energy fed to it.

loudness That subjective quality of a sound which determines the magnitude of the auditory sensation produced by the sound.

loudness level The intensity level in decibels of a pure 1,000-cycle tone that seems equivalent in loudness to the sound under consideration. The threshold of hearing for a 1,000-cycle tone is usually used as the reference level when specifying loudness levels in decibels. A decibel of change in level under these conditions is sometimes called a phon. Also called *equivalent loudness level*.

loudspeaker An electroacoustic transducer designed to radiate acoustic energy into a room or open air. The shorter term speaker is frequently used where no ambiguity will result, as in compound terms such as magnetic speaker and speaker field.

louwer A loudspeaker grill construction in which sloping horizontal slats, sometimes a part of a molded plastic cabinet, hide and protect the loudspeaker while allowing sound waves to pass.

low-definition television Television involving less than about 200 scanning lines in the picture.

low frequency A frequency in the band extending from 30 to 300 kilocycles in the radio spectrum. Federal Communications Commission designations for the entire radio spectrum are:

vlf	10 to 30 kilocycles
l-f	30 to 300 kilocycles
m-f	300 to 3,000 kilocycles
h-f	3 to 30 megacycles
vhf	30 to 300 megacycles
uhf	300 to 3,000 megacycles
shf	3,000 to 30,000 megacycles

low-frequency furnace An induction furnace that includes a primary winding, a core of magnetic material, and a secondary winding comprising one short-circuited turn of the material to be heated. Also called *core-type induction furnace*.

low-frequency padder In a superheterodyne receiver, a trimmer capacitor connected in series with the oscillator tuning coil and adjusted during alignment to obtain correct calibration of the circuit at the low-frequency end of the tuning range.

low-level modulation Modulation produced at a point in a system where the power level is low compared with the power level at the output of the system.

low-loss Having a low value of high-frequency resistance, and hence having but little extra loss at radio frequencies. Usually applied to construction involving the use of insulating materials that maintain their insulating characteristics at high radio frequencies.

low-pass filter A filter designed to pass currents at all frequencies below a critical or cutoff frequency, while substantially reducing the amplitude of currents at all frequencies above this critical frequency.

low-tension Low-voltage.

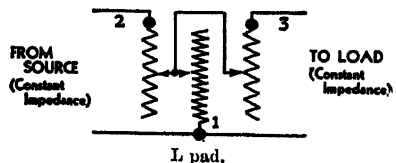

L pad A volume control having essentially the same impedance at all settings. It consists essentially of an L network arranged so that both of its elements can be adjusted simultaneously.

lpw Abbreviation for lumens per watt.

L-type antenna An inverted L antenna.

lug A small stamped metal strip riveted or otherwise placed on a terminal to provide a convenient anchor to which wires may be soldered.

lumen The unit of luminous flux. It is equal to the flux (illumination) on a unit surface all points of which are at unit distance from a uniform point source of one candle.

lumen-hour The unit of quantity of light. It is the quantity of light delivered in one hour by a flux of one lumen.

lumenophor A molecule or group of molecules that, according to the Kowalski theory of luminescence, is capable of emitting light when excited by an electron collision. The reverse action occurs in an electronogen.

luminaire A complete lighting unit consisting of a light source together with globe, reflector, refractor, housing, socket, and other parts integral with the housing.

luminescence Emission of radiation, especially visible light, as a result of absorption of radiant or corpuscular energy or by other causes, such as bioluminescence or chemiluminescence.

luminescent A general term applying to any material that gives off light when excited by a beam of electrons or a source of radiant energy.

luminous Emitting light.

luminous efficiency The ratio of the luminous flux (light capable of producing visual sensation) to the radiant flux (available radiant energy). Usually expressed in lumens per watt of radiant flux. Not to be confused with efficiency of a practical source of light, since the latter rating is

based on power supplied to the source instead of on total radiant energy coming from the source.

luminous flux The rate of emission of visible radiation, determining how much useful light is produced.

luminous intensity The strength of the illumination at a surface. It is the luminous flux on a small surface perpendicular to a line passing through the light source, divided by the solid angle in steradians which that surface subtends at the source of light.

luminous sensitivity In a phototube, the anode current divided by the incident luminous flux. This applies only to visible light, whereas static and dynamic sensitivity ratings for phototubes include total radiant flux (ultraviolet, visible, and infrared).

lumped Combined as a single value equivalent to a number of separated or distributed values.

lumped constant A single constant that is electrically equivalent to the total of that type of distributed constant existing in a coil or circuit.

lux The unit of illumination when the meter is taken as the unit of length. It is equivalent to meter-candle in the metric system, which corresponds to the foot-candle. The lux is the illumination produced on a surface all points of which are one meter away from a uniform point surface of one candle, or the illumination on a surface one square meter in area on which there is a uniformly distributed flux of one lumen. Also called *meter-candle*.

Luxemburg effect An action occurring in the atmosphere in which the modulated waves from a powerful transmitter will act on the carrier wave from another station of different frequency at some region in the atmosphere through which both waves pass, with the result that the program of the powerful station is distinctly audible during reception of the other station.

luxmeter A type of illumination photometer employing a variable aperture and the contrast principle.

M

- M** Roman numeral for 1,000.
- M** Letter symbol for mutual inductance.
- m** Abbreviation for meter.
- ma** Abbreviation for milliamperere.
- machine** A general term usually used to signify an apparatus with moving parts.
- machine-gun mike** The popular name for a line microphone.
- magic eye** Popular name for a cathode-ray tuning indicator tube.
- magnal base** An 11-pin base used for cathode-ray tubes.
- magnesium** An alkaline metal whose compounds are sometimes used for cathodes of phototubes when maximum response is desired in the ultraviolet region.
- magnesium-copper sulphide rectifier** A dry-disk rectifier consisting of magnesium in contact with copper sulphide.
- magnet** An object that produces a magnet field outside of itself. It has the property of attracting other magnetic objects such as iron, and attracting or repelling other magnets. A permanent magnet produces a permanent magnetic field, while an electromagnet possesses magnetic properties only when current is flowing through its windings.
- magnet brake** A friction brake controlled by electromagnetic means.
- magnetic analysis** The separation of a stream of electrified particles by a magnetic field in accordance with their mass, charge, or speed. This is the principle of the mass spectrograph.
- magnetic-armature loudspeaker** A loudspeaker whose operation involves vibration in a ferromagnetic circuit. Sometimes called *magnetic speaker*.
- magnetic bearing** A bearing given in relation to the magnetic north. A true bearing is given in relation to true geographic north, while a relative bearing is given in relation to the lubber line or other axis of an aircraft or vessel.
- magnetic blowout** An arrangement for producing a concentrated magnetic field near the arc produced when a switch is opened, to extinguish the arc by deflecting it into a longer path.
- magnetic braking** A system of electric braking in which the brakes are applied by magnetic force produced by electromagnets.
- magnetic chuck** An electromagnetic device for holding metal objects in a lathe by means of magnetic forces while they are being rotated and machined.
- magnetic circuit** A closed path of magnetic flux, with the path having the direction of the magnetic induction at every point.
- magnetic component** The electromagnetic component of a radio wave.
- magnetic contactor** A device, actuated by electromagnetic means, for repeatedly establishing and interrupting an electric power circuit.
- magnetic cycle** One complete cycle of changes in the magnetization of an object, corresponding to one cycle of the alternating current producing the magnetization. A hysteresis loop represents one complete magnetic cycle.
- magnetic damping** The damping of a mechanical motion by means of the reaction between a magnetic field and the current generated by the motion in a coil moving through the magnetic field. Used to prevent overshooting of moving parts.

MAGNETIC HYSTERESIS

magnetic declination The angle between true North (geographical) and magnetic north (the direction of the compass needle). This angle is different for different places, and changes continuously with respect to time.

magnetic dip The angle that the magnetic field of the earth makes with the horizontal at a particular location. Also called *magnetic inclination*.

magnetic dipole A simple loop antenna that is capable of radiating an electromagnetic wave in response to a circulation of electric current in the loop. For theoretical purposes, the elementary dipole is so small that its directive properties are independent of its size and shape. Analogous to the electric dipole or doublet. Also called *magnetic doublet*.

magnetic displacement Magnetic flux density or magnetic induction.

magnetic doublet A magnetic dipole.

magnetic energy storage Use of a magnetic field, such as that of a large iron-core coil, to store electrical energy.

magnetic-energy-storage spot welder A spot welder consisting of a special iron-core transformer with the primary connected to a direct-current source and the secondary connected to electrodes between which are the parts to be welded together. Current builds up slowly in the primary circuit after the primary switch is closed due to the large inductance of the primary, producing very little secondary current. When sufficient energy is stored in the transformer to weld the material at hand, the

primary circuit is opened. The stored energy develops a high current at low voltage in the secondary circuit, producing sufficient heat for welding purposes. By spreading power demands over a period of time, this welding system greatly reduces the power-system demand.

magnetic field A vector field of magnetizing force. As generally used, a magnetic field indicates the region throughout which the magnetizing force values are of significant magnitude with respect to the conditions under consideration. In effect, a magnetic field is any region in which the magnetic forces created by a permanent magnet or a current-carrying conductor or coil can be detected.

magnetic figures A pattern showing the distribution of a magnetic field, made by sprinkling iron filings on a nonmagnetic surface in the field.

magnetic flux Magnetic lines of force.

magnetic flux density The magnetic quantity (number of magnetic lines of force) that determines how much voltage will be induced in a conductor moving through a particular point in a magnetic field. It is the number of magnetic lines of force per unit area at right angles to the lines. More generally called *magnetic induction*.

magnetic focusing A method of focusing an electron stream in a cathode-ray tube through the action of a magnetic field.

magnetic force Same as magnetizing force or magnetic intensity.

magnetic hysteresis Internal friction occurring in a ferromagnetic substance

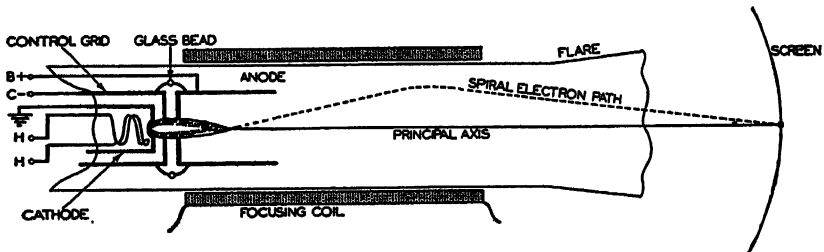

Magnetic focusing by means of a coil surrounding the neck of a cathode-ray tube.

MAGNETIC HYSTERESIS LOSS

such as iron or steel when subjected to a varying magnetic field. It is accompanied by generation of heat in the substance, and hence constitutes a loss.

magnetic hysteresis loss The energy converted into heat as a result of magnetic hysteresis in a material when the magnetizing force and magnetic induction are cyclic.

magnetic inclination Magnetic dip.

magnetic induction 1. The magnetic quantity (number of magnetic lines of force) that determines how much voltage will be induced in a conductor moving through a particular point in a magnetic field. It is expressed in gausses. Also called *magnetic flux density*. 2. The process of magnetizing an object by bringing it into the magnetic field of an electromagnet or permanent magnet.

magnetic intensity Magnetizing force or magnetic force.

magnetic leakage Passage of magnetic flux outside of the path along which it can do useful work.

magnetic lens An apparatus that focuses beams of rapidly moving electrons or ions in a cathode-ray tube or other device by means of a non-uniform magnetic field. The equivalent apparatus utilizing electric fields is an electron lens.

magnetic lines of force Imaginary lines used for convenience to represent the direction in which magnetic forces are acting in a magnetic field and to represent the strength of the magnetic field.

magnetic loudspeaker A loudspeaker in which the mechanical forces are due to magnetic relations between a moving iron armature and a fixed permanent magnet. In one type, a pivoted iron armature is mechanically coupled to the loudspeaker cone and is surrounded by a coil that is connected to the output of the radio receiver or audio-frequency amplifier. Interaction between the magnetic field developed in the armature by the

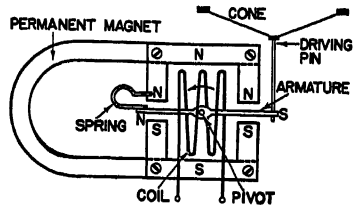
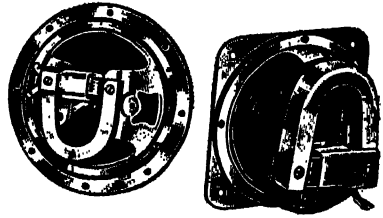

Examples and operating principle of balanced-armature magnetic loudspeakers.

coil and the permanent magnetic field of an adjacent permanent magnet results in movement of the armature and production of sound waves by the cone.

magnetic materials Materials that show magnetic properties. Ferromagnetic materials are strongly magnetic, while paramagnetic materials are feebly magnetic.

magnetic mercury switch A mercury switch actuated by movement of an external electromagnet or permanent magnet instead of by tilting. The magnet moves a soft iron armature inside the tube, causing the attached contact element to move into or out of a mercury pool forming the other contact.

magnetic microphone A microphone that depends for its operation on variations in the reluctance of a magnetic circuit.

magnetic mine An underwater mine provided with an arrangement of relays that causes it to detonate when the proximity of the steel hull of a ship causes a redistribution of the magnetic field at the mine.

magnetic modulator A modulator employing a magnetic circuit as the modulating element for impressing an intelligence signal on a carrier.

MAGNETIC STORM

magnetic moment The ratio of the maximum torque exerted on a magnet to the magnetizing force of the field in which it is situated.

magnetic pickup A phonograph pickup in which the electric output is generated in a coil or conductor located in a magnetic circuit or field. In one type, an iron armature is pivoted between the poles of a permanent magnet and surrounded by a coil. The phonograph needle traveling in the record groove moves the armature back and forth, thereby varying the amount of magnetic flux linking the coil and inducing an audio-frequency voltage in the coil.

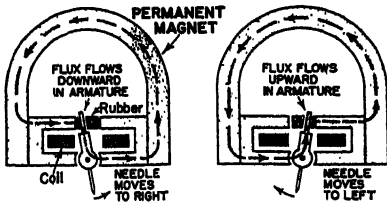

Operating principle of a magnetic phonograph pickup.

magnetic pole 1. Either of the two poles of a magnet (north pole and south pole) near which the magnetic intensity is greatest. 2. Either of two locations on the surface of the earth toward which a compass needle points. The north magnetic pole is near the north geographic pole and hence attracts the south pole of a compass needle.

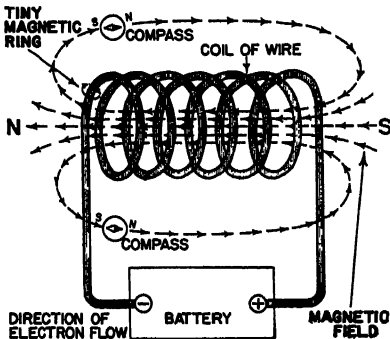

Left-hand rule for determining magnetic polarity when the direction of electron flow through a coil is known.

magnetic potential difference The line integral of magnetizing force between two points in a magnetic field.

magnetic relay A highly sensitive moving-coil relay, consisting essentially of a microammeter or millivoltmeter having a contact-making pointer on which is a small rider of magnetic material. A fixed permanent magnet attracts this rider when the relay closes, thus providing a contact pressure that can be several times greater than that obtainable with non-magnetic contacts. The relay must be reset manually or by a separate electric solenoid.

magnetics That branch of science which deals with the laws of magnetic phenomena.

magnetic saturation That condition in an iron core in which further increases in magnetizing force produce little or no increase in magnetic flux density. It represents the greatest number of magnetic lines of force the given object can carry.

magnetic separator An apparatus for separating powdered magnetic ores from nonmagnetic ores or for separating iron filings and other small iron objects from similar nonmagnetic materials. It employs an electromagnet to deflect magnetic materials from the path taken by the non-magnetic materials.

magnetic shield A soft iron housing used around delicate instruments or radio parts to protect them from the effects of stray magnetic fields by providing a low-reluctance path for those fields.

magnetic shunt A piece of iron, usually adjustable as to position, used to divert a portion of the magnetic lines of force passing through an air gap in an instrument or other device. Usually used for calibration purposes.

magnetic speaker A magnetic-armature loudspeaker.

magnetic storm Rapid and erratic changes in the strength of the magnetic field of the earth, believed due to ac-

MAGNETIC STRAIN GAGE

tivity on the sun. It seriously affects both radio and wire communications.

magnetic strain gage An instrument that depends on the change in the reluctance of a magnetic circuit having a movable armature, to measure strains in rails or other structural members that undergo very small deflection under load.

magnetic susceptibility The ratio of the magnetic intensity in a substance to the applied magnetizing force. It is the reciprocal of permeability.

magnetic tester An instrument for measuring the permeability or hysteresis of samples of iron or steel.

magnetic transition temperature The temperature of a ferromagnetic material at which, with increasing temperature, the transition from ferromagnetic to paramagnetic properties appears to be complete. Also called *Curie point*.

magnetic units Units used to measure magnetic quantities, such as the ampere-turn, gauss, gilbert, line of force, maxwell, oersted, and unit magnetic pole.

magnetic-vane meter An alternating-current meter containing a metal vane pivoted inside a coil in such a way that rotation of the vane and attached pointer due to magnetic forces is proportional to the value of the alternating current passing through the meter.

magnetic vector That component of the electromagnetic field associated with electromagnetic radiation which is like a magnetic field. It is supposed to exist always with an electric vector and act always at right angles to the electric vector.

magnetism A property possessed by iron, steel, and certain other materials when in a particular condition of internal structure, by which these materials can exert mechanical force on neighboring masses of magnetic materials and can cause voltages to be induced in conducting bodies

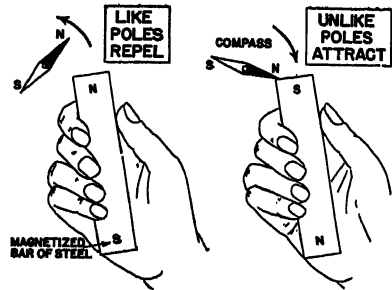

Law of magnetism.

moving relative to the magnetized bodies.

magnetite A mineral consisting chiefly of a magnetic oxide of iron that is found in its natural state in a magnetized condition. Often called *lodestone*.

magnetization 1. The degree to which a particular object is magnetized.
2. The process of magnetizing a magnetic material.

magnetization curve A curve plotted on a graph to show successive states during magnetization of a ferromagnetic material. A normal magnetization curve is a portion of a symmetrical hysteresis loop, while a virgin magnetization curve shows what happens the first time the material is magnetized. Also called *B-H curve*.

magnetizing force The force that produces magnetization of a substance. It is designated by the symbol H and is expressed in oersteds, which are the same as gilberts per centimeter. The corresponding force in connection with an electric field between two electrodes would be expressed in volts per centimeter. Also called *magnetic intensity* and *magnetic force*.

magnet keeper A bar of iron or steel placed across the poles of a horseshoe magnet to complete the magnetic circuit when the magnet is not in use, to avoid the self-demagnetizing effect of leakage flux.

magneto An alternating-current generator having a permanent magnet as its field.

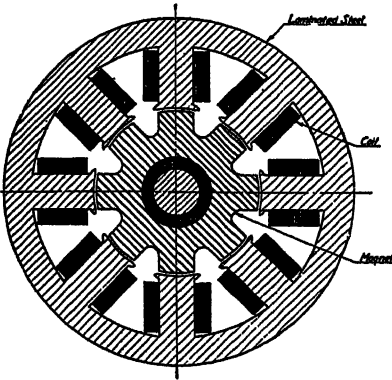

Cross-section view of a magneto using an eight-pole permanent magnet as rotor.

magneto compass A device used as a compass on aircraft, in which the inductive effect of the earth's magnetic field is utilized to excite the field magnet of a small magneto or generator. When the instrument is properly oriented with respect to north and south, the generated current reduces to zero.

magnetolectric generator An electric generator in which the field poles are permanent magnets.

magnetograph A magnetometer equipped to provide a continuous record of changes occurring in the magnetic field of the earth.

magnetometer An instrument for measuring the magnitude and sometimes also the direction of the magnetic induction of the earth, permanent magnets, or electromagnets.

magnetometer method Use of a magnetometer to test magnetic characteristics of an object by noting the deflection when a long bar of the substance to be tested is magnetized by a known current in a long solenoid.

magnetomotive force The force that is the cause of magnetic induction. It is the total magnetizing force acting around a complete closed magnetic circuit. If due to current in a coil, it is proportional to ampere-turns. The centimeter-gram-second unit of magnetomotive force is the gilbert, equal to about 0.8 ampere-turn.

magneton A theoretical unit of magnetic moment. The magnetic moments of all ferromagnetic atoms appear to be integral multiples of a magneton.

magnetoscope An instrument for detecting the presence of a magnetic field without measuring it.

magnetostriction The change in the dimensions of a ferromagnetic object when placed in a magnetic field. Also called *Joule effect*.

magnetostriction speaker A magnetostrictive loudspeaker.

magnetostrictive Changing in dimensions when placed in a magnetic field.

magnetostrictive loudspeaker A loudspeaker in which the mechanical forces result from the deformation of a material having magnetostrictive properties. Also called *magnetostriction speaker*.

magnetostrictive microphone A microphone that depends for its operation on the generation of an electromotive force by the deformation of a material having converse magnetostrictive properties.

magnetostrictive oscillator An oscillator whose frequency is controlled by a magnetostrictive resonator.

magnetostrictive resonator A ferromagnetic rod so designed and arranged that it can be excited magnetically into resonant vibration at one or more definite and known frequencies. Developed by G. W. Pierce.

magnetostrictive transceiver A magnetostrictive resonator used for sending and receiving signals under water at definite frequencies, usually above 17,000 cycles and hence in the supersonic range.

magnetron A high-vacuum thermionic tube in which a magnetic field (ex-



MAGNETRON EFFECT

ternally produced by a coil surrounding the tube) is used to control the unidirectional current flow. It is used for generating microwaves (radio waves below 1 meter in wavelength). In a split-anode magnetron, the cylindrical anode that surrounds the cathode is divided longitudinally into halves between which the oscillations are produced. In large magnetrons, handling powers up to about 1,000 kilowatts, continuous oscillations are produced in the plate circuit at twice the frequency of the high-frequency alternating field provided by the filament, without the use of a grid.

magnetron effect A reduction in the electron emission in a thermionic vacuum tube due to the magnetic field of the filament current. This imposes a limit on the output of large vacuum tubes.

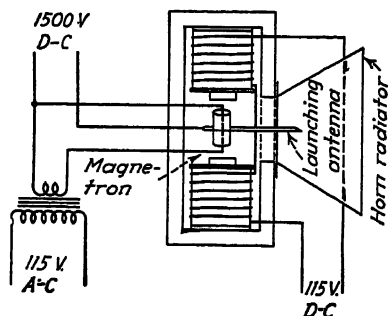

Magnetron-oscillator circuit, with external loop radiator projecting into a horn radiator.

magnetron oscillations Oscillations produced in thermionic vacuum tubes by the interaction of magnetic fields with electron streams.

magnetron oscillator An oscillator circuit employing a magnetron tube.

magnetron rectifier A gaseous vacuum-tube rectifier in which no electrodes are heated and the electron stream is controlled by an external magnetic field.

magnet steel Special steel having high retentivity, and usually containing some combination of tungsten, cobalt, chromium, and manganese with steel. Used in permanent magnets.

magnet wire Insulated copper wire in any of the sizes commonly used for winding the coils of electromagnets and electromagnetic devices used chiefly in radio equipment. It is single copper wire insulated with cotton, silk, or enamel.

mag-slip British trade name for a synchronous device like the selsyn, Autosyn, motor-torque generator, and Siemens, all of which are equal to the universal term synchro.

main receiver A receiver regularly available in a ship station for routine communication, and ordinarily energized by a source of power other than the emergency power supply.

main In interior wiring, the conductors extending from the service switch, generator, or converter to the main distribution center for wiring. In England, any power line.

main studio The studio from which the majority of the local programs of a radio station originate, and/or from which a majority of its station announcements are made of programs originating at remote points.

main transmitter A radio transmitter regularly available in a ship station for routine communication, and ordinarily energized by a source of power other than the emergency power supply.

major apex face One of the three large sloping faces extending to the apex or pointed end of a natural quartz crystal. The other three smaller sloping faces are the minor apex faces.

major face One of the three shorter sides of a natural hexagonal quartz crystal.

manganin An alloy containing 84 per cent copper, 12 per cent manganese, and 4 per cent nickel, used in making precision wire-wound resistors because of its low temperature coefficient of resistance. Another alloy similarly used is constantan.

man-made static High-frequency noise signals created by sparking in an

electric circuit. When picked up by radio receivers, it causes buzzing and crashing sounds.

manometer A pressure-measuring gage.

manual control An arrangement involving opening or closing of switching devices by hand.

manual telephone system A telephone system in which telephone connections between customers are ordinarily established manually by telephone operators in accordance with orders given verbally by calling parties.

manual tuning Rotation of the tuning-control knob of a radio receiver by hand to tune in a desired station.

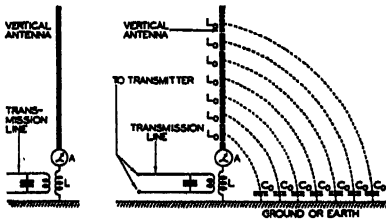

Marconi antenna characteristics.

Marconi antenna An antenna with its connection made to ground through suitable tuning reactances. The ground forms a part of the antenna system, as distinguished from a Hertz antenna which is not connected to the earth.

marine fire station A station used for intercommunication by radio between municipal fire departments and fireboats.

maritime mobile service A radio service carried on between maritime mobile stations and land stations, and by maritime mobile stations communicating among themselves.

marker antenna A transmitting antenna used with a marker beacon.

marker beacon A radio station located at a point intermediate between radio-range stations of an airway to give positional information to pilots. An M-type marker is a low-power non-directional station usually placed at

a point where a pilot should retune his receiver from one radio-range station to the next on his course. A Z-type marker is an ultrahigh-frequency transmitter that sends out a small inverted cone-shaped signal field directly above a range station to give a more positive indication than is provided by the cone of silence of the radio-range station. A fan-type marker is an ultrahigh-frequency transmitter used as a positive marker, and usually located a definite distance (such as 20 or 25 miles) from a congested radio-range station such as that in New York or Chicago, to facilitate traffic control about the station.

marking wave The emission that takes place in telegraphic communication while the active portions of the code characters are being transmitted. Also called *keying wave*.

Masonite A fiberboard made from steam-exploded wood fiber. Its highly compressed forms are sometimes used for panels in electrical equipment.

mass A measure of the quantity of matter in a body, as determined by comparing changes in velocities resulting from impacts with a standard body. The quantity of mass in a body is always constant, whereas the weight of a body depends on its distance from the center of the earth.

mass absorption coefficient The ratio of the X-ray absorption coefficient of a substance to its density.

mass radiator A mixture of movable metal particles suspended in a liquid dielectric medium, to which a high voltage is applied by an inductor. Sparking between the particles results in generation of electromagnetic waves having frequencies extending far into the infrared region.

mass spectrograph A mass spectrometer.

mass spectrometer An instrument consisting essentially of a vacuum tube in which is admitted a small amount of a gas to be studied. The molecules of the gas are ionized by electrons emitted from a thermionic cathode and

MASS SPECTRUM

speeded up by an accelerating grid. The various types of ions so formed are drawn out of the ionizing chamber by an applied electric field, then sent through a combination of electric and magnetic fields that sorts the ions according to their ratios of mass to charge. Used for rapid analysis of chemical compounds. Also called *mass spectrograph*.

mass spectrum The spectrum obtained by using an electric or magnetic field to deflect a beam of positive rays emerging from a tube containing a small quantity of the gas that is to be investigated. The amount of deflection will depend on the ratio of the mass of a particle to its atomic charge. Every element has characteristic mass spectrum lines. Many isotopes have been discovered by this method, which is now applicable to ionized metallic atoms as well as to gases.

mast A vertical or nearly vertical metal pole serving as an antenna, or a pole serving as an antenna support.

master The negative phonograph record produced directly from the original recording as one step in the manufacture of commercial records.

master control board The control board at which all the main operating controls of a broadcast studio or transmitter are located.

master oscillator An oscillator of comparatively low power, so arranged as to establish the carrier frequency of the output of an amplifier.

master oscillator-power amplifier A vacuum-tube oscillator stage followed by a radio-frequency amplifier.

matched impedance The coupling of two circuits in such a way that the coupling device matches the impedance of both circuits and thereby provides maximum transfer of energy.

matching Connecting two circuits or parts with a coupling device in such a way that each has the correct impedance for maximum transfer of energy.

matching impedance The impedance value that must be connected to the

terminals of a signal-voltage source for proper matching.

matching stub A conducting loop connected between the wires of a transmission line or a parallel-rod tank circuit at a particular position for matching purposes.

matching transformer A transformer used for matching purposes.

matrix 1. The negative from which duplicate phonograph records are molded. 2. A rectangular array of terms called elements, written with either a parenthesis or double vertical parallel lines on each side of the array, and used to facilitate the study of problems in which the relation between these elements is fundamental.

matrix mechanics The quantum mechanics of Heisenberg, expressed in the mathematical notation of matrices, and used chiefly to develop relations between frequencies and intensities of spectrum lines.

Matteucci effect Development of a voltage between the ends of a twisted ferromagnetic wire when its magnetization is changed.

max Abbreviation for maximum.

maximum The highest amount or point reached or registered.

maximum modulating frequency In a facsimile system, the frequency in cycles that is numerically equal to one-half the number of critical areas of the subject copy scanned per second. Also called *maximum keying frequency*.

maximum percentage modulation The highest percentage of modulation that can be used in a transmitter without producing harmonics of the modulating frequency in excess of those permitted by regulations.

maximum sound pressure The maximum absolute value of the instantaneous sound pressure at a point during any given cycle, expressed in dynes per square centimeter. For a sinusoidal sound wave, it is also called the pressure amplitude.

- maximum undistorted output** The maximum audio-frequency output power that a radio receiver or audio-frequency amplifier can deliver without having more than a specified value (usually 10 per cent) of total harmonic distortion. This amount of distortion is not ordinarily noticeable or objectionable.
- maximum usable frequency** The highest frequency that can be used for radio transmission between two points on the earth by reflection from the regular ionized layers of the ionosphere at a specified time. Higher frequencies are transmitted only by sporadic and scattered reflections.
- maxwell** The centimeter-gram-second electromagnetic unit of magnetic flux. It is equal to one gauss per square centimeter, or to one magnetic line of force.
- maxwell-turn** A unit of magnetic linkage, equal to one magnetic line of force passing through one turn of a circuit.
- Maxwell's equations** A series of fundamental equations developed by J. C. Maxwell to express radiation phenomena in mathematical form and to describe the condition at any point under the influence of varying electric and magnetic fields in a region that may contain conductors, dielectrics, and paramagnetic or ferromagnetic bodies. These equations are generally expressed in vector notation involving higher mathematics.
- Maxwell's law** A movable portion of a circuit will always move in such a direction as to give maximum flux linkages through the circuit.
- mayday** The international distress call for radio telephone systems. It is derived from the French word *m'aidez*, meaning "help me."
- MBS** Abbreviation for Mutual Broadcasting System.
- mc** Abbreviation for megacycle.
- McLeod gage** A device for measuring the pressure of a highly rarefied gas by compressing a portion of the gas, measuring the pressure thus "magnified," then calculating the original pressure.
- mcw** Abbreviation for modulated continuous waves.
- mean carrier frequency** The average carrier frequency of a transmitter, corresponding to the resting frequency in a frequency-modulation system.
- mean free path** The average distance that electrons travel in a particular gas between collisions with atoms or ions.
- mean spherical candlepower** The average of the candlepower values of a light source in all directions. It is equal to total luminous flux in lumens divided by 4π .
- mechanical axis** One of the Y axes in a quartz crystal. There are three, each perpendicular to one pair of opposite sides of the hexagon.
- mechanical bandspread** Use of a vernier tuning dial or other mechanical means to provide greater angular rotation of a control knob for a given tuning range, to simplify tuning in crowded short-wave bands.
- mechanical compliance** The displacement of a mechanical element per unit of force. It is the reciprocal of stiffness, is analogous to capacitance in an electrical system, and is expressed in centimeters per dyne.
- mechanical damping** Mechanical resistance due to friction of a moving object with air or with other objects, generally associated with moving elements of a cutter, phonograph pickup, or sound reproducer.
- mechanical impedance** In a mechanical system, the complex quotient of the applied alternating force divided by the resulting alternating linear velocity in the direction of the force at its point of application. The real component is mechanical resistance, and the imaginary component is mechanical reactance. The unit of mechanical impedance is the mechanical ohm or the dyne second per centimeter.
- mechanical joint** A joint in which cables or other conductors are clamped to-

MECHANICAL OHM

gether mechanically without the use of solder.

mechanical ohm A mechanical resistance, reactance, or impedance has a magnitude of one mechanical ohm when a force of one dyne produces a velocity of one centimeter per second.

mechanical reactance The magnitude of the imaginary component of mechanical impedance. The unit is the mechanical ohm.

mechanical record An electrical transcription or phonograph record.

mechanical rectifier A rectifier in which rectification is accomplished by mechanical action, as in a synchronous vibrator.

mechanical resistance The real component of mechanical impedance. The unit is the mechanical ohm.

mechanical scanning Use of a beam of light controlled by a rotating scanning disk, rotating mirror, or other mechanical device, to break up a scene into a rapid succession of narrow lines as required for conversion into electrical impulses in a television system.

mechanical television system A television system in which moving mechanical devices are employed at both the transmitter and receiver for scanning purposes.

medical ionization The therapeutic use of an electric current to introduce ions of soluble salts into tissues. Also called *ionic medication*.

medium frequency A frequency in the band extending from 300 to 3,000 kilocycles in the radio spectrum. Federal Communications Commission designations for the entire radio spectrum are:

vlf	10 to 30 kilocycles
l-f	30 to 300 kilocycles
m-f	300 to 3,000 kilocycles
h-f	3 to 30 megacycles
vhf	30 to 300 megacycles
uhf	300 to 3,000 megacycles
shf	3,000 to 30,000 megacycles

meg Sometimes used as abbreviation for megohm.

meg- or mega- A prefix meaning one million times. Thus, a megohm is 1,000,000 ohms.

megabar An absolute unit of pressure equal to one million bars. One megabar is almost exactly equal to normal atmospheric pressure.

megacycle One million cycles.

megatron One of a class of tubes characterized by the arrangement of the electrodes in parallel planes or layers, providing very low interelectrode capacitance along with high power output at extremely high frequencies. Megatrons are more popularly known as disk-seal tubes or lighthouse tubes.

Megger A high-range ohmmeter having a built-in hand-driven generator as a direct-voltage source, used for measuring insulation resistance values and other high resistances. Also used for continuity, ground, and short-circuit testing in general electrical power work.

megohm One million ohms.

Meissner oscillator A radio-frequency oscillator circuit in which coils in the grid and plate circuits of a vacuum tube are both coupled to coils in a separate resonant circuit that is tuned to the desired frequency. Feedback occurs through this resonant circuit.

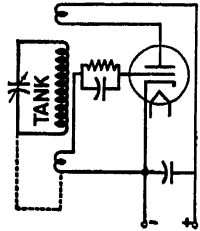

Meissner oscillator circuit.

mercury A silvery white liquid metal that becomes a solid at -40° Fahrenheit. It is used in mercury switches and in many electronic tubes. The vapor of mercury ionizes readily and conducts electricity.

mercury-arc rectifier A rectifier that utilizes the rectifying properties of an electron-emitting cathode and one or more anodes enclosed in a metal or glass chamber containing mercury vapor. Glass types are made in rat-

MERCURY-VAPOR RECTIFIER

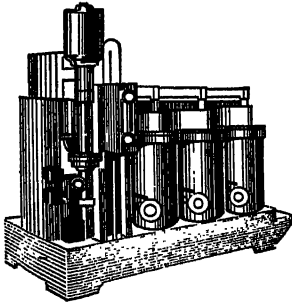

Mercury-arc rectifier for power plant.

ings to about 200 kilowatts, and iron-clad types range in size up to 8,000 kilowatts or higher. Small sizes ordinarily have a heated cathode, while the larger sizes use a mercury-pool cathode in which electron emission occurs at one or more self-heated spots in the pool of mercury.

mercury barometer An instrument for measuring the pressure of the atmosphere, consisting of a vertical glass tube containing mercury. The upper end of the tube is closed so as to form a practically perfect vacuum above the mercury, while the lower end rests in a mercury-filled cup. The column is sustained by the pressure of air against the mercury in the cup. A suitable scale alongside the glass tube measures the height of the mercury column. Normal atmospheric pressure is around 76 centimeters of mercury.

mercury rectifier A mercury-arc rectifier.

mercury switch An electric switch made by placing a large globule of mercury in a metal or glass tube having electrodes arranged in such a way that tilting the tube will cause the mercury to move and make or break the circuit.

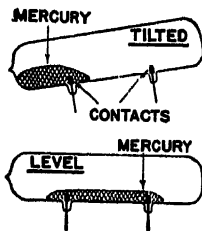

Mercury switch.

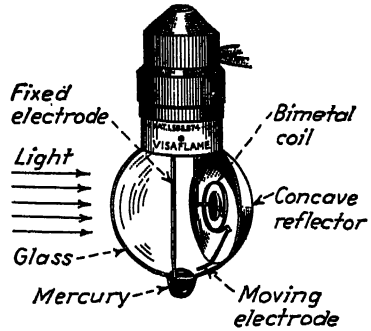

Mercury light-operated switch.

mercury-vapor lamp A glow lamp in which mercury vapor is the gas that is ionized by the flow of electric current and produces a luminous glow discharge.

mercury-vapor rectifier A rectifier tube consisting of a diode containing mercury vapor which, when ionized by the action of the positive plate, permits full cathode emission current to flow with only a small voltage drop in the tube.

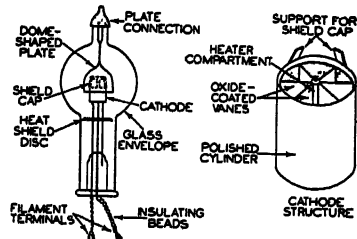

Mercury-vapor rectifier—typical construction.

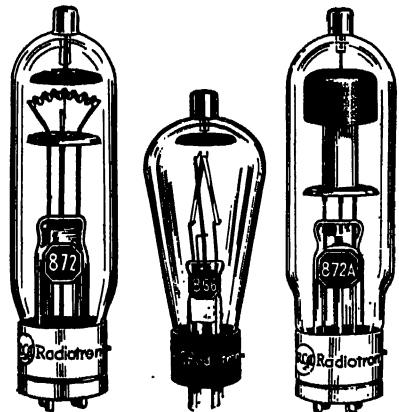

Mercury-vapor tubes.

MERCURY-VAPOR TUBE

mercury-vapor tube A gas tube in which the active contained gas is mercury vapor.

Mershon capacitor A wet electrolytic capacitor (trade name).

mesh A series of branches that form a complete loop in a network.

mesh circuit A combination of three resistors or other circuit components connected in series to form a triangle like the Greek letter delta Δ . Also called a *delta circuit*.

Mesny circuit An ultrahigh-frequency oscillator circuit employing a symmetrical arrangement of two vacuum tubes, with the grids and anodes, respectively, coupled by inductances to the power-pack terminals.

mesotron A particle having the same unit negative charge as an electron but a mass intermediate between that of the electron and the proton. Produced by cosmic radiation impinging on gas molecules, or actually forming a part of cosmic rays. Also called *barytron*, *dynatron*, *heavy electron*, *penetron*, *X particle*, etc.

metabolons Products of successive disintegration of radioactive materials.

metadyne A direct-current machine used in various forms for voltage regulation or voltage transformation, and having more than two brushes per pair of poles. British term.

metal detector An electronic device for detecting concealed metal objects, such as guns, knives, or buried pipe lines.



Metal detector used for locating mineral lode.

metallic circuit A circuit in which the ground or earth forms no part.

metallic insulator A short-circuited quarter-wave section of a transmission line. Such a line acts as an extremely high resistance at a frequency corresponding to its quarter-wavelength.

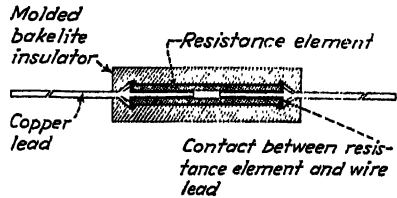

Construction of a metallized resistor.

metallized resistor A fixed resistor, originally one in which the resistance element was a thin film of metal deposited on the surface of a glass or ceramic rod or tube. The term is now a trade name used by one company for carbon resistors in general.

metal-tank mercury-arc rectifier A mercury-arc rectifier in which the anodes and the mercury cathode arc enclosed in a metal container or chamber.

metal tube A vacuum tube having a metal envelope, with electrode leads passing through glass beads fused into the metal housing. Metal tubes for receiving circuits have an octal base. Sometimes known as an *all-metal tube*.

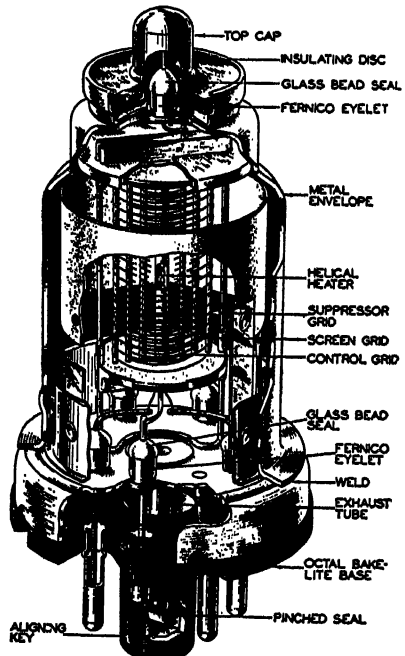

Construction of typical metal receiving tube.

meteorograph An apparatus for recording weather data, such as temperature, humidity, and pressure.

meter 1. A device that measures and registers the integral of an electric quantity with respect to time. Examples are watt-hour meter, ampere-hour meter, coulometer, var-hour meter. 2. Any type of electric measuring instrument such as a voltmeter, ammeter, wattmeter, ohmmeter. The term meter may be used alone for this wider meaning only when the usage is such as to prevent confusion with the narrower first meaning given. 3. The basic unit of length in the metric system, equal to 39.37 inches or 3.28 feet. A meter is equal to 100 centimeters or 1,000 millimeters.

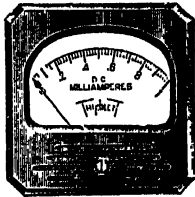

Example of one type of meter.

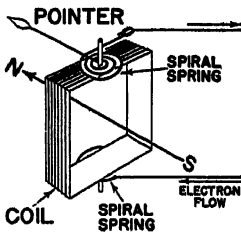

Meter movement.

meter-candle The illumination on a surface one meter away from a point source of one candle. Also called *lux*.

meter correction factor The factor by which the reading of a meter must be multiplied to compensate for meter errors and obtain the true reading.

meter-kilogram-second system See *mks electromagnetic system*.

meter-type relay A meter movement in which the contact-bearing pointer performs the same function as the armature of a relay.

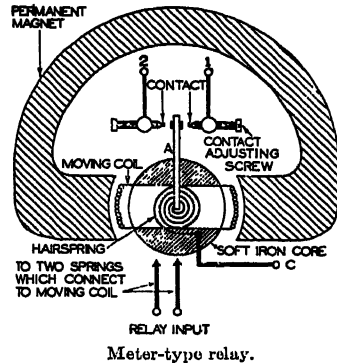

metric system A decimal system of weights and measures used extensively by scientists, and used for ordinary purposes also outside of the United States and Great Britain. It applies to length, area, volume, weight, and temperature. For any of these quantities, units are either divided or multiplied by 10 to make the next unit, much as in the United States decimal monetary system.

metric waves British classification for wavelengths between 1 and 10 meters.

m-f Abbreviation for medium frequency, a Federal Communications Commission designation for the band from 300 to 3,000 kilocycles in the radio spectrum. Same abbreviation used for noun as for adjective.

mfd Abbreviation for microfarad. Also written *mf* or μf . The preferred abbreviation is μf , without a period.

Mg Chemical symbol for magnesium.

mg Abbreviation for milligram.

mh Abbreviation for millihenry.

mho The unit of conductance or admittance. It is the reciprocal of the ohm. A resistance or impedance of one ohm is equal to a conductance or admittance of one mho.

mica A mineral occurring in a natural state as thin uniform sheets consisting chiefly of silicates of aluminum and potassium, having good insulating and heat-resisting qualities. When split into thin sheets, it is used to separate

MICA CAPACITOR

the plates of mica capacitors, to space the electrodes accurately in vacuum tubes, and for many other insulating purposes. Also used in various finely divided forms with binding materials for molding sheets, tubes, and other objects under pressure.

mica capacitor A fixed capacitor employing mica sheets as the dielectric material between adjacent plates. The complete units are usually encased in molded Bakelite.

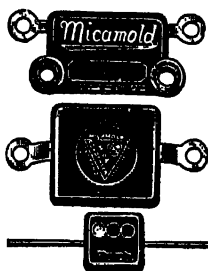

Mica capacitors.

Micanite Mica combined with special varnishes and molded into special shapes under pressure for insulating purposes

Micarta An insulating material made by compressing a mixture of mica and a binding material such as Bakelite to produce panels and other shapes not possible with sheet mica.

Michelson-Morley experiment An experiment made in 1887, indicating that the earth carries the ether around with it. The velocity of light as measured first in the direction of, then at right angles to, the earth's motion was found to be the same. The experiment was confirmed in 1928.

micro- A prefix meaning one-millionth of. Designated by the Greek letter μ (mu) in abbreviations.

microammeter A meter used to measure extremely small currents, having a scale that reads in microamperes.

microampere One-millionth of an ampere. Generally abbreviated μa , without a period.

microfarad One-millionth of a farad. The preferred abbreviation is μf ; other forms are mf and mfd.

microhenry One-millionth of a henry. Abbreviated μh , without a period.

microhm One-millionth of an ohm.

micrometer In the electric version, an instrument for measuring extremely small movements by converting them either into changes of capacitance or into changes in the reluctance of an air gap in a magnetic circuit.

micromho One-millionth of a mho.

micromicro- A prefix meaning one-millionth of one-millionth of. Designated by the Greek letter μ (mu) used twice, as in $\mu\mu\text{f}$.

micromicrofarad One-millionth of a microfarad. The preferred abbreviation is $\mu\mu\text{f}$; other forms are mmf and mmfd.

micron A unit of length equal to one-millionth of a meter or one-thousandth of a millimeter, and designated by the symbol μ .

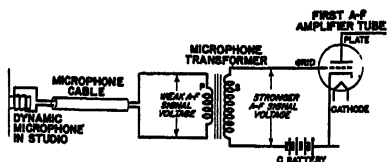

Typical microphone circuit.

microphone A device that converts sound waves into audio-frequency signals. It is an electroacoustic transducer actuated by energy in an acoustic system and delivering energy to an electrical system, with the waveform in the electrical system being substantially equivalent to that in the acoustic system. Pressure microphones include carbon, capacitor, moving-coil (dynamic), and crystal microphones. Velocity microphones include hot-wire and ribbon microphones.

microphone adapter A device that slips under a tube or is otherwise connected to a radio receiver, and provides terminals to which a microphone can be

MICROWAVE OSCILLATOR

connected to convert the receiver into a public-address system. Phonograph pickup connections to a radio receiver can be made in a similar manner.

microphone amplifier An audio-frequency amplifier that amplifies the output of a microphone which is connected to its input, prior to sending the audio-frequency signal over a transmission line to the main audio-frequency amplifier. Sometimes, particularly with capacitor microphones, this amplifier is built into the microphone housing or stand. Also called *microphone preamplifier*.

microphone button A button-shaped telescoping container filled with carbon particles and serving as the resistance element of a carbon microphone.



Microphone cable with unshielded twisted wires embedded in a rubber outer sheath.

microphone cable A special shielded cable used to connect a microphone to a microphone amplifier.

microphone preamplifier A microphone amplifier.

microphone stand A stand used to support a microphone in a desired position above the floor or on a table.

microphone transformer An iron-core transformer used for coupling certain types of microphones to a microphone

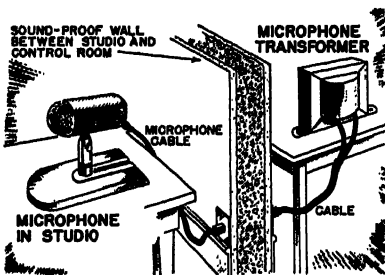

The microphone transformer in the control room of a broadcast station is connected to the microphone in the studio by the microphone cable.

amplifier, to a transmission line, or to the main audio-frequency amplifier.

microphonic A condition in which mechanical movement of a vacuum tube, variable capacitor, or other part in an amplifier system causes corresponding variations in circuit current; heard as noise or howling.

microphonic tube A vacuum tube in which the electrodes are insufficiently rigid and hence liable to vibrate and produce microphonic noise.

microphotometer A photometer providing a high degree of accuracy in illumination measurements. In one form, the changes in illumination are picked up by a phototube and converted into current variations that are amplified by vacuum tubes.

microradiometer An instrument for measuring very weak radiation.

microray oscillator tube A triode tube used for generating extremely high frequencies, having an oscillating electrode constructed like the grid of an ordinary triode and having a reflecting electrode constructed like the plate of a triode.

microscope An instrument for providing an enlarged or magnified image of a small object. An ordinary microscope uses one or more optical lenses, while an electron microscope employs electron beams and electron lenses to provide magnifications of the order of 100,000 times.

microvolt One-millionth of a volt. Abbreviated μv , without a period.

microvoltmeter A highly sensitive voltmeter that measures voltages in microvolts.

microvolts per meter A measure of the intensity of the signal produced by a radio transmitter at a given point. It is equal to the signal strength in microvolts at the receiving antenna divided by the effective height of the antenna in meters. Stronger signals are expressed as millivolts per meter.

microwave oscillator An oscillator that generates frequencies higher than

MICROWAVES

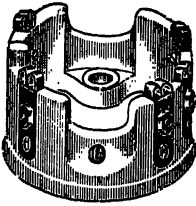

Acorn tube socket made from a low-loss ceramic compound for use in microwave equipment.

about 300 megacycles (wavelengths shorter than about 1 meter).

microwaves Electromagnetic waves that are shorter than about 1 meter in wavelength.

mike Commonly used as abbreviation for microphone.

mil A unit of length equal to one-thousandth of an inch, used chiefly in specifying diameters of round conductors.

milammeter A milliammeter.

mil-foot A wire having a diameter of 1 mil and a length of 1 foot.

Miller bridge A type of bridge circuit for measuring amplification factors of vacuum tubes.

Miller effect The increase in the effective grid-cathode capacitance of a vacuum tube due to the charge induced electrostatically on the grid by the plate through the grid-plate capacitance.

milli- A prefix meaning one-thousandth of.

milliammeter A meter that measures current values in milliamperes.

milliampere A unit of current equal to one-thousandth of an ampere. Abbreviated ma, without a period.

millihenry A unit of inductance equal to one-thousandth of a henry. The plural is millihenrys. Abbreviated mh, without a period.

millilambert A unit of brightness equal to one-thousandth of a lambert. Abbreviated mL, without a period.

millimeter A metric unit of length equal to one-thousandth of a meter, or approximately $\frac{1}{25}$ th inch (0.03937 inch). Abbreviated mm, without a period.

millimicron A unit of length equal to one-thousandth of a micron, and hence equal to one-millionth of a millimeter.

milliohm One thousandth of an ohm.

millivolt A unit of voltage equal to one-thousandth of a volt. Abbreviated mv, without a period.

millivoltmeter A voltmeter that measures voltage values in millivolts.

millivolts per meter A measure of the intensity of the signal from a radio transmitter at a given point. It is equal to the signal strength in millivolts at the receiving antenna divided by the effective height of the antenna in meters. Weaker signals are expressed as microvolts per meter.

milliwatt A unit of power equal to one-thousandth of a watt. Abbreviated mw, without a period.

min Commonly used as abbreviations for minute and minimum.

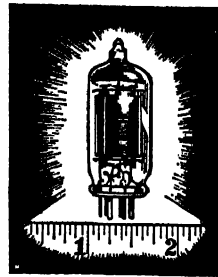

Miniature thyratron tube.

miniature thyratron A small gas-type grid-controlled tetrode, such as the type 2D21 which is only $1\frac{1}{8}$ inches high and weighs but $\frac{1}{2}$ ounce.

Minimax battery A highly efficient and compact dry battery employing a flat construction in which the zinc electrode of one cell is coated with a thin layer of carbon serving as the positive electrode of the next adjacent cell. This eliminates connecting wires when

MKS ELECTROMAGNETIC SYSTEM

the cells are used in series as in B batteries for miniature receivers, hearing aids, radiosonde units, etc.

minimum The lowest amount or point reached or registered. Abbreviated min, without a period.

minimum wavelength The shortest wavelength in an X-ray spectrum produced by an X-ray tube. It is definitely related to the maximum voltage applied to the tube, in accordance with the Planck-Einstein quantum equation. Also called *quantum limit*.

minor apex face One of the three smaller sloping faces near but not touching the apex (pointed end) of a natural quartz crystal. The larger three sloping faces are the major apex faces.

minor face One of the three longer sides of a natural hexagonal quartz crystal.

minus sign The sign $-$, used to indicate subtraction or to indicate a negative value. In electronics, it also serves to indicate negative polarity or the negative terminal of a device.

minute One-sixtieth of a unit, as of an hour or an angular degree. Denoted by a single accent; thus, $17'$ is 17 minutes. A second is one-sixtieth of a minute and is denoted by a double accent $''$.

mirror galvanometer

A galvanometer having a small mirror attached to the moving element, to permit use of a beam of light as an indicating pointer.

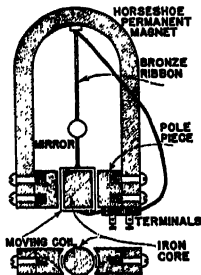

Mirror galvanometer.

mismatch The condition in which the impedance of a source does not match or equal the impedance of the connected load.

mismatching factor The ratio of the load current that would be delivered by a particular generator to a particular load without matching, to the load current obtained when generator and

load impedances are matched. Also called *reflection factor* or *transition factor*.

mixer 1. A device ordinarily consisting of one or more potentiometers for combining the audio-frequency output signals of two or more microphones or other audio-frequency signal sources in any desired proportion at the input of a main audio-frequency amplifier. 2. That stage in a superheterodyne receiver in which the incoming modulated radio-frequency signal is mixed with the signal from the local oscillator to produce the intermediate-frequency signal. Also called *mixer-first detector stage*.

mixer-first detector stage The mixer stage.

mixer stage That stage in a superheterodyne receiver in which the radio-frequency signal from the local oscillator is combined with the incoming modulated radio-frequency signal to produce the modulated intermediate-frequency signal. Also called the *first detector*.

mixer tube The vacuum tube used in the mixer stage of a superheterodyne receiver.

mixing Combining two or more signals, such as the outputs of several microphones.

mks electromagnetic system An absolute system of units, based on the meter, kilogram, and second as fundamental units and extended to electrical units by the measurement of current by its magnetic effects and by the measurement of potential difference by the power per unit current. The mechanical units of the system are based on unity as the proportionality factor in the recognized equations of mechanics, plus insertion of a new unit of force for which the name *newton* has been proposed. Each of the electrical units of the mks system has the same name and the same value as the corresponding unit of the *practical system* of electrical units. There is lack of agreement concerning extension of the mks system to magnetic and electrostatic units. Also called *Giorgi system*.

ML

mL Abbreviation for millilambert.

mm Abbreviation for millimeter.

mmfd Abbreviation for micromicrofarad. Also written mmf or $\mu\mu\text{f}$. The preferred abbreviation is $\mu\mu\text{f}$, without a period.

m **mu** or **m μ** Abbreviation for millimicron.

mobile receiver A radio receiver designed to be operated while in motion, as on an automobile or carried by troops.

mobile service A radio service carried on between mobile and land stations and by mobile stations communicating among themselves.

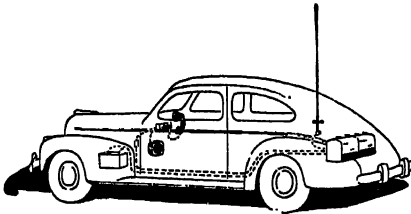

Mobile station in police patrol car.

mobile station A radio station operated at a movable location as on an automobile, airplane, ship, train, fire truck, or with troops.

mobile transmitter A radio transmitter designed to be operated while in motion and normally operated in that manner.

modes of propagation The methods of electromagnetic wave propagation in wave guides. These modes are related to the nodal diagrams of a vibrating membrane.

modulate To vary, such as to vary the amplitude or frequency of an oscillation in some characteristic manner.

modulated amplifier That stage in a radio transmitter at which the intelligence signal is made to modulate the radio-frequency carrier signal.

modulated-beam photoelectric system A photoelectric intrusion-detector system in which reliable beam ranges of several thousand feet are obtained by

interrupting the light beam at the source with a rotating punched or slotted disk, thus amplifying the output of the phototube.

modulated light Light that has been made to vary in intensity in accordance with variations in an audio-frequency or code signal or at a regular rate produced by a rotating or vibrating shutter.

modulated quantity A combination of two or more oscillating quantities that results in the production of new frequency components not present in the original oscillating quantities.

modulated stage The radio-frequency stage to which the modulator is coupled and in which the continuous wave (carrier wave) is modulated in accordance with the system of modulation and the characteristics of the modulating wave.

modulated wave A carrier wave whose amplitude, frequency, or phase is varied in accordance with an intelligence signal.

modulating electrode An electrode to which a potential is applied to control the magnitude of the beam current in a cathode-ray tube.

modulating wave The audio-frequency or other intelligence signal wave that is made to vary the amplitude or other characteristic of a carrier wave in the process of modulation.

modulation The process in which the amplitude, frequency, or phase of a carrier wave is varied with time in accordance with an intelligence signal.

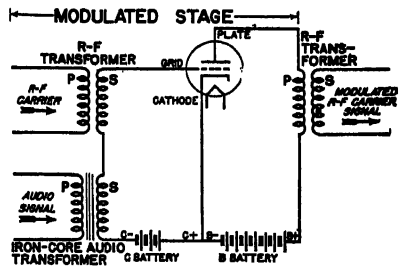

Simplified circuit diagram of the modulated stage of a broadcast transmitter.

modulation capability The maximum percentage modulation that is possible without objectional distortion.

modulation distortion Distortion occurring in the radio-frequency amplifier tube of a receiver when the operating point is the bend of the grid-voltage-plate-current characteristic curve, so that greater plate-current changes are obtained on positive half-cycles than on negative half-cycles. The effect is equivalent to an increase in the percentage modulation.

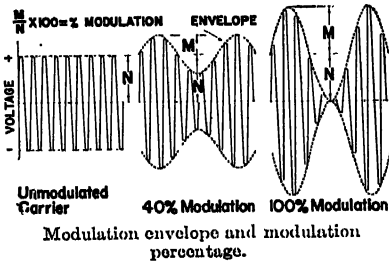

modulation envelope A curve drawn through the peaks of a graph showing the waveform of a modulated signal. The modulation envelope represents the waveform of the intelligence carried by the signal.

modulation factor For an amplitude-modulated wave, the ratio of half the difference between the maximum and minimum amplitudes to the average amplitude. This ratio is multiplied by 100 to get percentage modulation.

modulation index Modulation factor.

modulation monitor An instrument used to provide a continuous indication of the modulation percentage at a transmitter.

modulation percentage The modulation factor multiplied by 100 for expressing as a percentage.

modulator 1. In a broadcast transmitter, the final audio-frequency amplifier stage. It feeds an audio-frequency signal into the modulated amplifier stage for combining there with the radio-frequency carrier signal. 2. In any radio transmitter, the last stage handling the intelligence signal by

itself. 3. A device for bringing about the process of modulation. It may operate by virtue of some nonlinear characteristic or by a controlled variation of some circuit quantity.

modulator stage The modulator. It is the last amplifier stage through which passes the modulating wave that modulates a radio-frequency stage.

mol Alternative abbreviation for gram molecule.

molded capacitor A capacitor, usually mica, that has been encased in a molded plastic insulating material to keep out dust and moisture.

mole Abbreviation for gram molecule.

molecular pump A vacuum pump in which the molecules of the gas to be exhausted are carried away by the friction between them and a rapidly revolving disk or cylinder.

molecular theory of magnetism The assumption that each molecule of matter is a separate magnet and that, in ferromagnetic materials, these molecules all line up with their magnetic poles pointing in the same direction when the material is magnetized.

molecule The smallest group of atoms of a compound or material that retains chemical identity with the substance in mass. In a gas, it is the smallest portion of a substance that moves about as a whole.

molybdenum A metal element sometimes used for grid and plate electrodes of vacuum tubes.

momentum The mass of a body multiplied by its linear velocity

monel metal An alloy of about 70 per cent nickel, 28 per cent copper and 2 per cent iron, having excellent rust-resisting qualities.

monitor A receiver or loudspeaker used for checking (monitoring) radio programs at a studio or transmitter, or the person assigned to this duty.

monitoring Listening to a program or watching a television image for technical reasons.

MOTOR ELEMENT

to that part of the patient being treated and connecting this electrode to the positive terminal of the machine, then grounding the negative terminal and using a suitable spark gap between the terminals.

mosaic In television, the light-sensitive surface of an iconoscope or other television camera tube. In one form it consists of millions of tiny silver globules on a sheet of ruby mica, with each globule treated with caesium vapor to make it sensitive to light.

mother 1. A mother crystal. 2. The positive sound record obtained in the second stage of producing phonograph records. The grooves are sunken like those in the final records. The mother is plated, and the resulting platings are called stampers. These in turn are used in presses to produce the final shellac records in quantities.

mother crystal A quartz crystal as found in nature. It originally has a characteristic geometric design with flat faces always at definite angles to each other, but generally all or some of the faces are worn due to abrasion with stones in the creek beds in which crystals are often found.

motional impedance In an electro-acoustic transducer, the vector difference between the normal impedance and the blocked impedance.

motion-picture pickup Use of a television camera to pick up scenes directly from motion-picture film.

motor A machine that converts electric energy into mechanical energy.

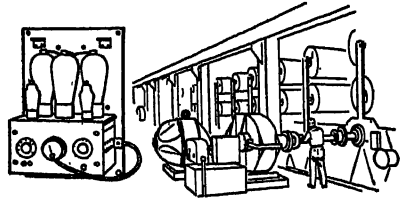

Motor control with electronic tubes.

motorboating Feedback occurring in pulses at an audio-frequency rate in an audio-frequency amplifier or radio receiver, causing sounds resembling those made by a motorboat.

motor element That portion of a telephone receiver (loudspeaker or headphone) that receives power from the electric system and converts it into mechanical power.

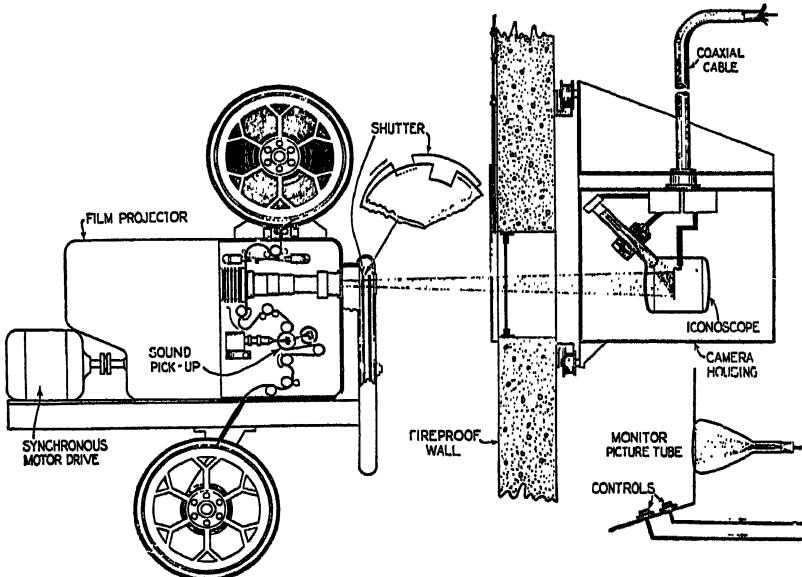

Motion-picture pickup, consisting of a film projector directed into a television camera.

MOTOR-FIELD CONTROL

motor-field control Controlling the speed of a motor by changing its field current.

motor-generator set A motor and generator used together as a converter for changing power-line voltage to other desired voltages or frequencies. The most common example is a direct-current generator on the same shaft with an alternating-current motor, used to obtain direct-current power from an alternating-current line.

motor-torque generator British trade name for a synchronous device like the selsyn, Autosyn, mag-slip, and Siemens, all of which are equal to the universal term synchro.

mouse mill A simple motor-driven static machine used in early siphon recorders to charge the capillary tube of a pen and make the ink flow freely.

mouth That end of a horn having the larger cross-sectional area.

moving-armature loudspeaker A magnetic loudspeaker. Operation involves vibration of an armature that is a portion of the magnetic circuit.

moving-coil galvanometer A galvanometer in which a suspended or pivoted coil is the moving element.

moving-coil instrument Any instrument in which the moving system that carries the pointer or mirror, or other indicating device, consists essentially of a pivoted coil constrained by springs or a suspended coil constrained by the torsion of the suspension, with the coil carrying all or a known fraction of the current to be measured. The coil is positioned in a magnetic field provided either by a permanent magnet or another coil.

moving-coil loudspeaker A loudspeaker in which the coil carrying the audio-frequency current is attached to the moving diaphragm or cone, and moves in and out of a constant magnetic field produced either by a permanent magnet (p-m dynamic loudspeaker) or by an electromagnet or field coil (electrodynamic loudspeaker). Interaction between the fixed magnetic

field and that of the moving coil (called the voice coil) produces the motion that reproduces the desired sound waves. Also called *dynamic loudspeaker*.

moving-coil meter A meter in which a pivoted coil is the moving element.

moving-coil microphone A moving-conductor microphone in which the movable conductor has the form of a coil. Usually called *dynamic microphone*.

moving-conductor loudspeaker A loudspeaker in which the mechanical forces are developed by the interaction of the field set up by the currents in the conductor and the polarizing field surrounding it.

moving-conductor microphone A magnetic microphone in which the electric output results from the motion of a conductor (either in the form of a ribbon or coil) in a magnetic field.

moving element That part of an instrument which moves as a direct result of a variation in the electric quantity the instrument is measuring.

moving-iron instrument A meter that depends for its operation on interaction between one or more fixed coils and one or more movable pieces of soft iron. The plunger, vane, repulsion, attraction, and repulsion-attraction forms of this instrument are distinguished chiefly by mechanical features of construction.

mph Abbreviation for miles per hour.

MST Abbreviation for Mountain Standard Time.

mu Greek letter μ , used as a symbol for amplification factor, for micron (a unit of length), and for the prefix micro-.

mu a or μa Abbreviation for microampere. μa is preferred.

mu factor The ratio of the change in one electrode voltage to the change in another electrode voltage, under the conditions that a specified current remains unchanged and that all other electrode voltages are maintained constant. It is a comparison of the relative effects of two electrodes on the

MULTIPATH TRANSMISSION

current in the circuit of a particular electrode. Amplification factor is a special case of mu factor.

Muller tube A thermionic vacuum tube having an auxiliary cathode or grid connected to the main cathode internally through a high-value resistor.

multiband antenna An antenna that may be used satisfactorily on more than one frequency band.

multichannel television A television system in which the picture is divided into a very large number of separate elements, with these in turn being divided into two or more sections each transmitted by a separate transmitter on a different frequency band. A corresponding number of receivers is required to pick up the different sections of the complete signal.

multielectrode tube A vacuum tube containing more than three electrodes associated with a single electron stream.

multifrequency radio set A combination radio transmitter and receiver capable of operating on a number of different frequencies.

multigrid tube A vacuum tube having more than one grid electrode.

multimeter A single test instrument having a number of different ranges for measuring voltage, current, and resistance. Also called *multiple-purpose tester*, *volt-ohm-milliammeter*, etc.

multipath cancellation Effectively complete cancellation of radio signals arriving over different paths. This term is usually used in connection with square-wave modulation of the radio-frequency carrier or a subcarrier.

multipath effect The condition in which radio waves arrive at a receiving point at slightly different times because they travel over paths that appreciably differ in length. The delay can be appreciable compared with the time of duration of a telegraph dot or of a small element in material being transmitted by television or facsimile.

multipath transmission The propagation phenomenon that results in signals reaching a radio receiving antenna by two or more paths. There are usually both amplitude and phase differences between the signals.

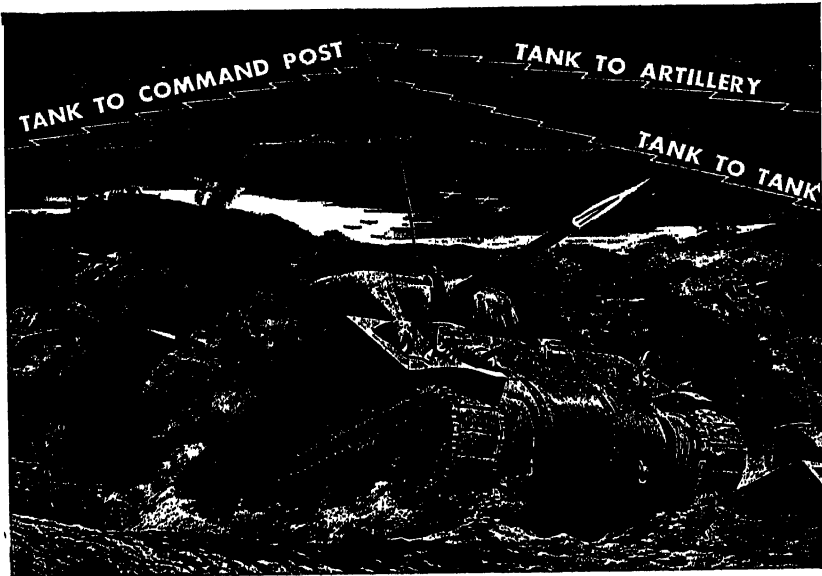

Multifrequency radio sets operating on 80 crystal-controlled channels, any 10 of which may be instantly selected by pushbuttons, provide instant communication facilities for tanks, scout cars, aircraft, and other mobile military vehicles. Frequency modulation is used.

MULTIPLE

multiple 1. A number that is the product of a given number and another factor. Thus, 24 is a multiple of 8 and 3. 2. Same as parallel, with respect to connections.

multiple connection The connecting of two or more devices in parallel.

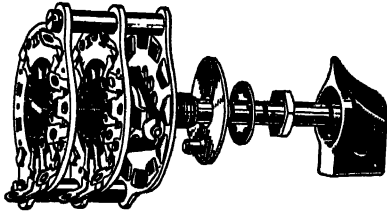

Multiple-contact selector switch, widely used for changing bands in all-wave receivers.

multiple-contact switch A switch in which the movable contact can be moved over a number of different fixed contacts.

multiple modulation The process of modulation in which a carrier wave of one frequency is first modulated by an intelligence signal, and the resultant signal wave is then made to modulate a second carrier wave having a second frequency, etc. Double modulation is an example.

multiple-purpose tester A single test instrument having a number of different ranges for measuring voltage, current, and resistance. Also called *multimeter*, *volt-ohm-milliammeter*, etc.

multiple resonant line A cylinder with two end plates inside which are mounted a number of coaxial cylinders fixed alternately to one or the other end plate, with the free ends of the cylinders not quite reaching the opposite plate. The arrangement is equivalent to a number of coaxial lines connected in series, each formed by the outer surface of one cylinder and the inner surface of the next larger cylinder. Also called *polycylindrical endovibrator*.

multiple-tuned antenna An antenna with connections to ground or counterpoise through tuning reactances at more than one point. The points are

so determined that their reactances in parallel constitute a total reactance equal to that needed to give the antenna the desired resonant frequency.

multiple twin quad A structural unit employed in cables, consisting of four separately insulated conductors arranged in two twisted pairs, with the two pairs twisted together.

multiple-unit steerable antenna A receiving antenna system in which the vertical angle of maximum response can be adjusted to obtain optimum selectivity and to reduce interference. Abbreviated *musa*.

multiple-unit tube A vacuum tube containing within one envelope two or more groups of electrodes associated with independent electron streams. Examples are duodiode, duotriode, diode-pentode, duodiode-pentode, etc.

multiplex code transmission Simultaneous transmission of two or more code messages in either or both directions over the same transmission path.

multiplex operation Simultaneous transmission of two or more messages in either or both directions over the same transmission path in a telegraph system.

multiplex printing telegraphy That form of printing telegraphy in which the line circuit is employed to transmit in turn one character (or one or more impulses of a character) from each of two or more independent channels.

multiplex radio transmission The simultaneous transmission of two or more signals using a common carrier wave.

multiplex telegraphy Telegraphy employing multiplex code transmission.

multiplex transmission The simultaneous transmission of two or more signals by means of a common carrier wave. Multiplex transmission as applied to high-frequency broadcast stations means the transmission of facsimile or other aural signals in addition to the regular broadcast signals.

multiple X-Y recorder A recorder that plots simultaneously a number of independent charts, each showing the relation of two variables neither of which is time. In one model, frequency deviation and activity of quartz crystals are plotted against temperature. Electronic circuits are used.

multiplier A resistance used in series with a voltmeter to permit measurements of higher voltages than are indicated on the meter scale.

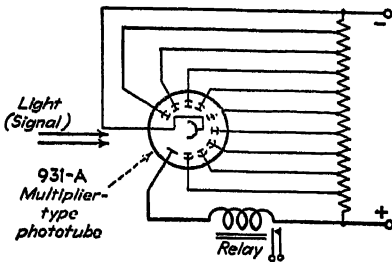

Basic circuit of multiplier phototube.

multiplier phototube A vacuum-type phototube that employs secondary emission to amplify the electron stream emitted from the illuminated photocathode. The electron stream impinges in turn on each of a series of reflecting electrodes called dynodes, at each of which secondary emission adds electrons to the stream. In one tube, an amplification of approximately 2,000,000 is obtained with nine dynodes. Also called *electron-multiplier phototube* and *photoelectric electron-multiplier tube*.

multiplier tube A vacuum tube utilizing secondary emission from a number of electrodes in sequence to obtain increased output current. The electron stream is reflected in turn from one electrode of the multiplier to the next. Examples are the multiplier-type phototube and the multiplier in one type of Farnsworth television camera tube.

multiplying factor The number by which the reading of a given meter must be multiplied to obtain the true value.

multipolar Having more than one pair of magnetic poles.

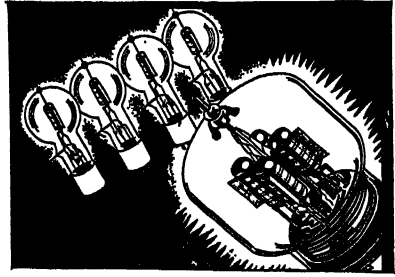

Multiunit radio transmitting tube, equivalent to four triodes.

multiunit tube A vacuum tube containing within one envelope two or more groups of electrodes, each associated with separate electron streams.

multivibrator A vacuum-tube oscillator circuit employing two tubes (or a double section tube) with resistance-capacitance coupling between the tubes to feed the output back and forth between them. The output frequency is determined by the time constants of the coupling networks, but the frequency can readily be controlled externally by a weak signal introduced in the circuit. It produces an essentially square-wave output having many strong harmonics of the fundamental frequency. Used mainly in television circuits to generate sweep voltages for cathode-ray tubes.

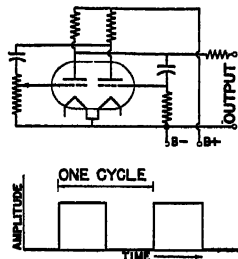

Multivibrator circuit and square-top wave it produces.

Mumetal A magnetic alloy having high permeability and low hysteresis, consisting of about 75 per cent nickel, 25 per cent iron, and very small quantities of copper and manganese. Used in moving-iron instruments, loaded submarine cables, etc.

MUNICIPAL POLICE STATION

municipal police station A station used by a municipal or county police department for emergency radiotelephone service with mobile police units.

Murray loop test A method of localizing a fault in a cable by replacing two arms of a Wheatstone bridge with a loop formed by the cable under test and a good cable connected to the far end of the defective cable. The bridge battery is grounded. After the bridge is balanced, the ratio of resistances in the two remaining arms then gives the ratio of resistances of the portions of the cable loop on each side of the fault. From this, the position of the fault can be easily and accurately computed.

musa Abbreviation for multiple-unit steerable antenna.

muting Silencing, or reducing in volume.

muting switch A switch used in connection with automatic tuning systems to silence the receiver while tuning from one station to another.

mutual conductance The amplification factor of a vacuum tube divided by the alternating-current plate resistance. More generally, it is the inphase component of the alternating current of one electrode divided by the alternating voltage of another electrode, all other electrode voltages being maintained constant. The control grid-plate transconductance is ordinarily the most important, and is commonly understood to be intended when either of these terms is used. Also called *transconductance*.

mutual impedance In connection with any two pairs of terminals of a network, the ratio of the open-circuit

voltage between either pair of terminals to the current applied at the other pair of terminals, all other terminals being open. As ordinarily used, mutual impedance is additive if two coils of a transformer are aiding when connected in series or parallel, and is subtractive when the coils oppose each other.

mutual inductance The common property of two associated electric circuits determining, for a given rate of change of current in one of the circuits, the amount of electromotive force induced in the other. Mutual inductance is measured in henrys and designated by *M*.

mutual induction The inducing of a voltage in one circuit by a varying current in a neighboring circuit when there is inductive coupling between the two circuits.

mu w or μw Abbreviation for microwatt. μw is preferred.

mv Abbreviation for millivolt.

mw Abbreviation for milliwatt.

Mycalex A molded insulating material consisting chiefly of ground mica and lead borate.

mystery control Popular name for a miniature radio transmitter that produces radio waves used to control equipment through space without wires. Examples of commercial versions are those which tune a radio receiver from any location in a home, start garage door-opening or closing mechanisms, or transmit the output of an electric phonograph to a radio receiver at some other location in a home.

N

N Symbol for nitrogen.

Na Chemical symbol for sodium.

National Electric Code A set of regulations governing construction and installation of electrical wiring and apparatus in the United States, established by the American National Board of Fire Underwriters for safety purposes.

National Television System Committee A committee organized in 1940 and comprised of representatives of all United States companies and organizations interested in television. It formulated a set of television standards that were acceptable to the majority and were approved by the Federal Communications Commission.

natural frequency The lowest resonant frequency of an antenna or other device or circuit, without added inductance or capacitance.

natural period The period or frequency of the free oscillation of a body or system.

natural resonance Resonance in which the period or frequency of the applied agency maintaining oscillation is the same as the natural period of oscillation of a system. Also called *periodic resonance*.

natural wavelength The wavelength corresponding to the natural frequency of an antenna or circuit.

NBC Abbreviation for National Broadcasting Company.

NC Designation for no connection. Used on tube-base diagrams.

Ne Chemical symbol for neon.

NEC Abbreviation for National Electric Code. Also called Underwriter's Code.

needle The stylus that rides in the grooves of a phonograph record and converts groove variations into mechanical movements that are in turn converted into audio-frequency signals by the phonograph pickup.

needle chatter See *needle talk*.

needle pressure The effective weight of a phonograph pickup at the needle.

needle scratch Noise components in the output of a phonograph pickup due to rough particles in the phonograph record material or to irregularities left in the walls and bottom of the record grooves by the cutting stylus. Also called *surface noise*.

needle talk Sounds directly produced by vibrations set up in a phonograph needle and associated parts of a phonograph pickup. Also called *needle chatter* or *record noise*.

negative 1. A terminal or electrode having more electrons than normal. Electrons flow out of the negative terminal of a voltage source. 2. A designation used to describe an opposite character to positive, as in negative resistance, negative transmission, negative feedback, etc.

negative bias A grid bias voltage that makes the control grid of a vacuum tube negative with respect to its cathode.

negative charge That type of charge in which the object in question has more than its normal number of electrons.

negative compliance A condition of unstable equilibrium in a mechanical element, in which small displacement results in a force tending to give a further displacement in the same direction.

NEGATIVE ELECTRICITY

negative electricity That kind of electricity which predominates in a body composed of resin after it has undergone electrification by rubbing with wool.

negative electrode The body of conducting material that serves as the anode in a primary cell when the cell is discharging. It is connected to the negative terminal of the cell. Electrons flow from the negative electrode to the negative terminal, then out through the external circuit.

negative feedback A vacuum-tube-circuit arrangement in which a signal is fed back from the plate circuit to the grid circuit in such a way that it is 180 degrees out of phase with the input signal, decreasing the amplification. It is used in radio-frequency circuits to improve the stability by preventing oscillation, and in audio-frequency circuits to reduce distortion and noise in order to permit greater undistorted power output. Also called *degeneration*, *inverse feedback*, and *stabilized feedback*.

negative feedback amplifier An amplifier that employs negative feedback to improve stability or frequency response, or both.

negative glow A luminous glow in a Crookes tube or other discharge tube at moderate pressure, occurring between the Crookes dark space and the Faraday dark space.

negative-grid generator Any conventional oscillator circuit in which oscillation is produced by feedback from the plate circuit to a grid which is normally negative with respect to the cathode.

negative impedance A characteristic of certain electrical devices or circuits, in which the current increases (instead of decreases) when voltage is decreased. If there is no inductance or capacitance in the circuit, the property is called negative resistance.

negative ion An atom having more electrons than normal.

negative modulation 1. In an amplitude-modulated television or facsimile sys-

tem, that form of modulation in which maximum transmitted power corresponds to minimum light intensity at the television camera or maximum density or blackness of the subject copy in facsimile. 2. In a frequency-modulation facsimile system, it is that form of modulation in which the highest transmitter frequency corresponds to the maximum density of the subject copy.

negative modulation factor The ratio of the maximum negative departure of the envelope of an amplitude-modulation wave from its average value, to its average value. This rating is used when the modulating signal wave has unequal positive and negative peaks.

negative picture phase For a television signal, the condition in which increases in brilliancy make the picture signal voltage swing in a negative direction, below the zero level.

negative plate The grid and active material connected to the negative terminal of a storage battery. Electrons flow from this terminal through the external circuit to the positive terminal when the battery is discharging.

negative resistance A resistance that varies with current in such a way that when the current increases the voltage drop across the resistance decreases. This characteristic is possessed by an electric arc, and by vacuum-tube circuits under certain conditions.

negative temperature coefficient A temperature coefficient expressing the amount of reduction in the value of a quantity, such as resistance, for each degree of increase in temperature.

negative terminal That terminal of a battery or other voltage source having more than a normal number of electrons. Electrons flow from it through the external circuit to the positive terminal.

negative transmission The transmission of television signals in such a way that a decrease in initial light intensity causes an increase in the transmitted power.

negatron 1. An electron. 2. A four-electrode vacuum tube having the characteristics of a negative resistance.

NELA Abbreviation for National Electric Light Association.

NEMA Abbreviation for National Electric Manufacturers Association.

nemo A program originating outside the studios of a radio station and hence requiring portable equipment.



Neon circuit tester.

neon An inert gas used in neon signs and in some vacuum tubes. It produces a characteristic bright red glow when ionized.

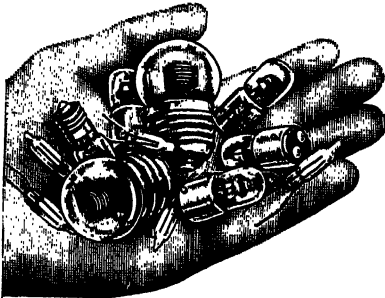

Neon glow lamps, used as signals or indicators on test equipment, radio sets, ignition systems, panel boards, as stroboscopic illuminants and as night lights.

neon glow lamp A neon-filled two-electrode gas tube having a glass envelope. Ionization of the gas during operation produces a characteristic red glow that can be used for illumination, signaling, and other purposes.

neon lamp A neon glow lamp.

neon oscillator An oscillator circuit consisting of a neon glow lamp and a capacitor, sometimes also with a resistor. The frequency of oscillation is determined by the capacitor value and by the value of the series resistance.

neon tubing A glow lamp in which neon is the gas that is ionized by the flow of

electric current and produces a luminous glow discharge. It is used chiefly in outdoor advertising signs. There is a popular tendency to use this term for all luminous tubing used in advertising, even though other gases are employed to obtain the different colors. Neon has a characteristic reddish color.

neper A unit used, as is the decibel, to express the relation between two amounts of power (acoustic, electric, or other power) in a logarithmic manner. The number of nepers is equal to the natural (Napierian) logarithm of the square root of the ratio of the two powers or levels being compared. One neper is equal to 8.686 decibels.

Nernst bridge A four-arm bridge containing capacitors instead of resistors, used for measuring capacitance values at high frequencies.

Nernst lamp An electric lamp consisting of a short slender rod of zirconium oxide that is heated to brilliant white incandescence by current.

net A number of communications stations equipped for communication with each other, often on a definite time schedule and in a definite sequence.

network 1. A system of interconnected impedances, which may be any combination of resistors, inductors, and capacitors. 2. A number of broadcast stations connected by radio or wire telephone lines so that all stations can broadcast the same program simultaneously.

network constants The resistances, inductances, mutual inductances, and capacitances that make up a network. If these values are constant, the network is said to be linear. Also called *parameters*.

network show A radio program produced in one or more main studios and broadcast simultaneously over two or more stations that are interconnected by telephone lines to form a network.

neuroelectricity Electric current generated in the nervous system.

neutral In a normal condition, hence neither positive nor negative. A neu-

NEUTRALIZATION

tral object has a normal number of electrons.

neutralization The process of nullifying the voltage fed back through the inter-electrode capacitance of an amplifier tube, by providing an equal voltage of opposite phase.

neutralize To prevent regeneration by inserting some device into an amplifier circuit to balance the feedback voltage due to grid-plate capacitance.

neutralized radio-frequency stage A radio-frequency amplifier stage having an additional circuit connected between the plate and the grid of the tube to feed back in the reverse direction an amount of energy equivalent to that which is feeding back through the tube and causing oscillation. This neutralizes any tendency to oscillate, making the tube function strictly as an amplifier.

neutralizing capacitor A capacitor, usually variable, employed in a radio receiving or transmitting circuit to feed a portion of the signal voltage from the plate circuit of a stage back to the grid circuit. The feedback voltage is 180 degrees out of phase with the grid voltage, and lowers the gain of the stage sufficiently to prevent oscillation due to feed-back through the grid-plate inter-electrode capacitance of the tube

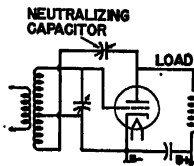

Neutralizing capacitor used to cancel feedback.

neutralizing circuit That portion of an amplifier circuit which provides an intentional feedback path from plate to grid to prevent regeneration

neutralizing tool A small screwdriver or socket wrench, partly or entirely nonmetallic, used for making neutralizing or aligning adjustments in radio equipment.

neutral relay A relay in which the movement of the armature does not depend on the direction of the current in the circuit controlling the armature. Sometimes called *nonpolarized relay*.

neutrino A hypothetical uncharged particle having a smaller mass than the neutron.

neurodyne An amplifier circuit containing a capacitor that neutralizes the internal capacitance between the plate and the grid of the amplifier tube by feeding an out-of-phase signal from the plate circuit to the grid circuit. This neutralizes the tendency of the circuit to oscillate. Used in early tuned-radio-frequency receivers.

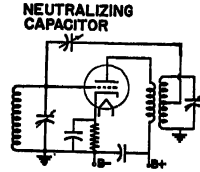

Neurodyne circuit.

neutron An electrically neutral particle having mass approximately equal to that of a proton.

newscast A radio broadcast of the latest news.

newscaster One who edits and broadcasts news at a radio station. Called a commentator if facts are interspersed with personal opinions.

newton A unit of force. One newton is equal to 100,000 dynes.

Ni Chemical symbol for nickel.

Nichols radiometer An instrument devised by Nichols to demonstrate that light or other radiation exerts pressure. It can be used to measure the intensity of both visible and infrared radiation.

Nichrome An alloy of iron, nickel, and chromium having high electric resistance and the ability to withstand high temperatures for long periods of time. It is used extensively in wire-wound resistors and in all types of electric heating elements.

nickel silver A silver-white alloy consisting essentially of copper, nickel, and zinc. Formerly called *German silver*.

Nicol prism Two prism-shaped segments of Iceland spar (a transparent crystalline material) cemented together with Canada balsam. It produces plane-

polarized light from unpolarized (ordinary) light because the ordinary component of the original light is entirely eliminated by total reflection at the cementing layer. Only the extraordinary component passes.

night effects Original name for polarization errors in the bearings or course indicated by a radio beacon or direction finder, introduced by horizontally polarized components of the electric field under certain transmission conditions, usually at night.

night error The error in a radio-direction-finder indication due to night effects or polarization errors.

Nipkow disk A flat round plate having one or more spirals of holes around the outer edge, with successive openings positioned so that rotation of the disk provides scanning of small elementary areas of an image in correct sequence for a mechanical television system.

noble gas One of a group of chemically inert gases, including helium, neon, argon, krypton, and xenon. Also called *inert gas* or *rare gas*.

noctovision A television system employing invisible rays, usually infrared, for scanning purposes at the transmitter to give the equivalent of seeing in the dark.

nodal diagram A diagram showing the manner in which a stretched membrane vibrates under a particular condition. Nodal diagrams are used to indicate the order and mode of E waves and H waves being propagated in wave guides.

nodal point A node. Usually assumed to be a voltage node, having zero potential with respect to ground.

nodal point keying Keying of an arc transmitter at a point in the antenna circuit that is essentially at ground potential at all times.

node Any point, line, or surface in a stationary-wave system at which the amplitude of the wave-shaped variable is zero. The type of node is usually specified, since there can be nodes

of voltage, current, pressure, etc. The corresponding term for maximum amplitude is antinode.

Nodon valve An electrolytic rectifier consisting of an aluminum cathode rod in a lead container serving as anode and filled with an electrolyte of ammonium phosphate.

noise Interference whose energy is distributed over a wide band of frequencies, heard along with desired radio programs. It may be due to static, man-made interference, or a circuit defect.

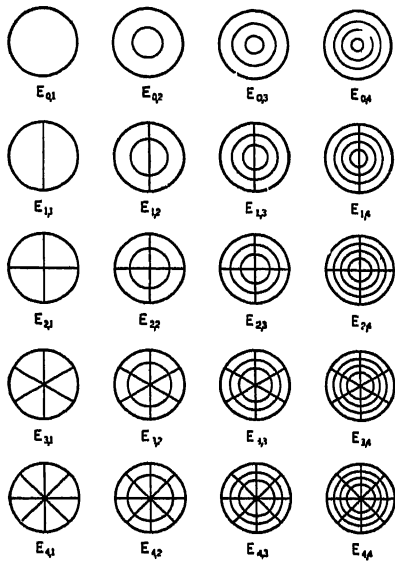

Nodal diagrams for stretched circular membrane, with order and mode of corresponding E wave in a wave guide.

noise analysis Determination of the frequency components that make up a particular noise being studied.

noise field intensity The field intensity of noise in a transmission medium, defined only with reference to a definite frequency band.

noise filter A combination of one or more choke coils and capacitors inserted between the power cord plug of a radio receiver and a wall outlet to block noise interference that might

NOISELESS RECORDING

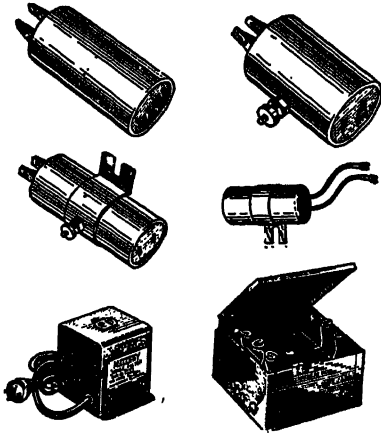

Examples of noise filters used with electrical appliances and motors for radio interference suppression. Each type of filter is best suited for particular applications, the largest type being permanently connected between the power line and motor, and smaller types being inserted between the appliance line cord and the wall outlet.

otherwise reach the receiver through the power line.

noiseless recording Recording of sound on motion-picture film in a carefully controlled manner so there is a minimum of background noise at low sound levels.

noise level The strength of acoustic noise at a particular location, or the strength of noise signals at a particular point in a circuit. Usually expressed in decibels.

noise limiter A vacuum-tube circuit that cuts off all noise peaks that are stronger than the highest peak in the desired signal being received, thereby preventing loud crashing noises due to strong atmospheric or man-made interference.

noise measurement 1. Use of a sound-level meter to measure the loudness in decibels of sounds due to noise. 2. The measurement of telephone line noise in arbitrary units by means of a potentiometer arrangement for comparing this signal noise with that produced by a standard noise generator.

noise-reducing antenna system A receiving antenna system so designed that only the antenna proper can pick up signals. It is placed high enough to be out of the noise-interference zone, and is connected to the receiver with a shielded cable or twisted transmission line that is incapable of picking up signals.

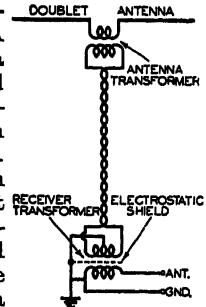

Noise-reducing antenna circuit.

noise silencer A vacuum-tube circuit than can be introduced into a super-heterodyne receiver circuit to reduce the effects of static and man-made interference noises. Used chiefly in short-wave communication receivers.

noise suppression A receiver circuit arrangement that automatically reduces the noise output during periods when no carrier is being received.

no-load losses Losses existing when a device is operated at rated voltage and frequency but is not supplying power to a load.

nominal band In facsimile, the frequency band that is equal in width to that between the zero frequency and the maximum modulating frequency.

nominal line width In facsimile, the reciprocal of the number of lines per unit length in the direction of line progression.

nomogram A nomograph.

nomograph A chart or diagram on which equations can be solved graphically by placing a straightedge on the two known values and reading the answer where the straightedge crosses the scale for the unknown value. Also called *alignment chart* or *nomogram*.

noncommercial educational broadcast station A station licensed to an organized nonprofit educational agency for the advancement of its educational work and for the transmission of edu-

NONSTORAGE CAMERA TUBE

ational and entertainment programs to the general public.

nonconductor An insulating material.

noncorrosive flux Flux that is free from acid and other substances that might cause corrosion when used in soldering.

nonhoming tuning system A motor-driven automatic tuning system in which the motor starts up in the direction of previous rotation. If this is incorrect for the new station, the motor reverses after tuning to the end of the dial, then proceeds to the desired station.

nonhygroscopic A material that does not absorb or retain moisture to an appreciable degree.

noninductive capacitor A capacitor so constructed that it has practically no inductance. Foil layers are staggered during winding, so that an entire layer of foil projects at either end for contact-making purposes and all currents flow laterally rather than around the capacitor.

noninductive circuit A circuit having practically no inductance.

noninductive load A load having no inductance. It may consist entirely of resistance as in the case of electric lamps, or it may be capacitive.

noninductive resistor A wire-wound resistor constructed to have practically no inductance, either by use of a hairpin winding or by reversing connections to adjacent sections of the winding.

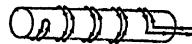

HAIRPIN-TYPE
Non-Inductive Winding

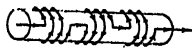

SECTION-TYPE
Non-Inductive Winding

Examples of windings of noninductive resistors.

noninductive winding A winding constructed so that the magnetic field of one turn or section cancels the field of the next adjacent turn or section.

nonlinear Not directly proportional, hence giving a curve instead of a straight line when the two values in question are plotted on a graph.

nonlinear distortion That form of distortion which occurs when the ratio of voltage to current is a function of the magnitude of either. The introduction of parasitic frequencies in a circuit is an example, as these are dependent on the amplitude of the incoming signal.

nonmagnetic Not magnetizable, and hence not affected by magnetic fields. Examples are air, glass, paper, and wood. All have a magnetic permeability of 1, the same as a vacuum.

nonmagnetic steel A steel alloy containing about 12 per cent manganese and sometimes a small quantity of nickel. It is practically nonmagnetic at ordinary temperatures.

nonmagnetic watch A watch that is not affected by a magnetic field. The balance spring is usually made of a nonmagnetic material such as palladium.

nonpolarized relay A relay in which the movement of the armature does not depend on the direction of the current in the circuit controlling the armature. Sometimes called *neutral relay*.

nonresonant line A transmission line whose natural resonant frequency is different from the frequency of the signal being transmitted.



WIDTH OF ROTOR TOOTH
LESS THAN DISTANCE BETWEEN CONTACT CLIPS
NON-SHORTING TYPE

WIDTH OF ROTOR TOOTH
GREATER THAN DISTANCE BETWEEN CONTACT CLIPS
SHORTING TYPE

Nonshorting- and shorting-type switches.

nonshorting contact switch A selector switch in which the width of the movable contact is less than the distance between contact clips, so that the old circuit is broken before the new circuit is completed.

nonsinusoidal wave A wave whose form differs from that of a sine wave, and which hence contains harmonics.

nonstorage camera tube A television camera tube in which the picture signal is at each instant proportional to

NONSYNCHRONOUS

the intensity of the illumination on the corresponding elemental area of the scene at that instant.

nonsynchronous Not related in frequency or speed to other frequencies in a device or circuit.

nonsynchronous vibrator A vibrator that interrupts a direct-current circuit at a frequency unrelated to other circuit constants and does not rectify the resulting stepped-up alternating voltage.

norm 1. The mean or average. 2. The customary condition or degree.

normal 1. The perpendicular to a line or surface at the point of contact. 2. The expected or regular value of a quantity.

normal cut An X cut in a quartz crystal.

normal electrode A standard electrode used for measuring electrode potentials. It is made of a material that gives a known potential difference between itself and the electrolyte in which it is immersed.

normal impedance For an electroacoustic transducer, the measured terminal impedance of its electric system when the mechanical system is connected to its normal load.

normal induction The limiting induction, either positive or negative, in a magnetic material that is under the influence of a magnetizing force varying between two specific limits.

normally closed A term applied to a magnetically operated switching device or to its contacts in order to specify the position taken when the operating magnet is deenergized.

normally open A term applied to a magnetically operated switching device or to its contacts in order to specify the position taken when the operating magnet is deenergized.

normal permeability The ratio of the normal induction to the corresponding magnetic intensity

normal temperature and pressure The temperature of 0° centigrade and pressure of 1 atmosphere, sometimes abbreviated ntp.

north pole That pole of a magnet at which magnetic lines of force are considered as leaving the magnet. The lines enter the south pole.

notching A term indicating that a predetermined number of separate impulses is required to complete operation of a relay.

Novachord An electronic musical instrument that duplicates the effects of an organ by means of oscillator and amplifier circuits.

ntc Abbreviation for negative temperature coefficient.

ntp Abbreviation for normal temperature and pressure, namely, 0° centigrade and 1 atmosphere.

NTSC Abbreviation for National Television System Committee.

nuclear theory The concept that an atom consists of a central positively charged nucleus having considerable mass but minute dimensions, surrounded by a number of electrons moving in orbits at a relatively great distance from the nucleus.

nucleus The central part of an atom, containing most of its mass and having an excess positive charge equal to the negative charges of the orbital electrons. It may consist of a single proton as in the hydrogen nucleus, or of protons and electrons.

null Zero.

null indicator Any device that indicates when current is zero. Used chiefly to determine when a Wheatstone bridge circuit is in balance.

null method Any method of measurement in which the reading is taken after the circuit has been balanced to bring the pointer of the indicating instrument to zero, as in a Wheatstone bridge or in a laboratory balance for weighing purposes. Also called *balance method* or *zero method*.

O Chemical symbol for oxygen.

objective That lens in an optical system which first receives light, or the equivalent electron lens in an electronic system.

oblique-incidence transmission The transmission of a radio wave obliquely up to the ionosphere and down again.

obsolescence free So designed that it is not likely to become outdated because of new inventions or new developments. Frequently applied to tube testers and other test instruments.

occlude To absorb. Some metals will take up gases, and these gases must be driven out when the metals are incorporated in the electrode structures or supports of vacuum tubes.

occluded gas Gas absorbed in a material, as in the electrodes, supports, leads, and insulation of a vacuum tube.

octal base A tube base having a central aligning key and positions for eight equally spaced pins. Pins not needed for a particular tube are omitted without changing the positions of the remaining pins.

octave The interval between two frequencies having a ratio of 2:1. Thus, going one octave higher means doubling the frequency, and going one octave lower means changing to one-half the original frequency. The reference frequency for music in the United States is 440 cycles. With this, 440 to 880 cycles is one octave, 880 to 1,760 cycles is the next higher octave, and 220 to 440 cycles is the next lower octave.

octode An eight-electrode vacuum tube containing an anode, a cathode, a control electrode, and five additional electrodes ordinarily in the nature of grids.

OD Abbreviation for outside diameter.

odograph An automatic electronic map tracer used in jeeps and other mobile military vehicles for map making and navigation on land. It automatically plots on an existing map or on cross-section paper the exact course taken by the vehicle. Phototubes and thyratrons transfer the indications of a precision magnetic compass to a plotting unit actuated by the speedometer drive cable, causing a pencil to trace the course taken on roads or on cross-country movements.

oersted The unit of magnetic intensity (magnetizing force) in the centimeter-gram-second electromagnetic system. The value of the magnetic intensity in oersteds, at any point in a vacuum, is equal to the force in dynes exerted on a unit magnetic pole placed at the point. The oersted replaced the term gauss by international agreement in 1930. Before 1930, the oersted was the centimeter-gram-second electromagnetic unit of magnetic reluctance.

ohm The practical unit of electrical resistance. It is that resistance in which one volt will maintain a current of one ampere.

ohmic value Resistance in ohms.

ohmmeter An instrument for measuring electric resistance. It consists essentially of a direct-current milliammeter, a direct-voltage source, and one or more resistors. Its scale is usually graduated in ohms or megohms.

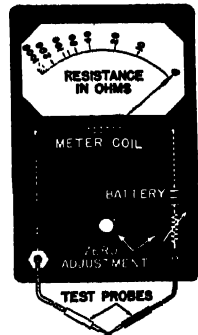

Basic circuit of a series-type ohmmeter.

OHMMETER ZERO ADJUSTMENT

ohmmeter zero adjustment A potentiometer or other means provided to compensate for the reduction of battery voltage with age in an ohmmeter. The adjustment is usually made by rotating a knob until the meter pointer is at zero on the resistance scale being used.

Ohm's law The current in a circuit is directly proportional to the total electromotive force in the circuit and inversely proportional to the total resistance of the circuit.

ohms per volt A sensitivity rating for measuring instruments, obtained by dividing the resistance of the instrument in ohms at a particular range by the full-scale voltage value at that range. The higher the ohms-per-volt rating, the more sensitive is the meter.

oil circuit breaker A device that opens an alternating-current circuit in a tank of insulating oil that extinguishes the arc.

oiled paper Paper that has been treated with an insulating oil or varnish to improve its insulating qualities.

oil switch A switch in which the interruption of the circuit occurs in oil, to suppress arcing.

SMALL LETTER
OMEGA
MEANS
2πf

Omega—common radio uses.

CAPITAL LETTER
OMEGA
MEANS
OHMS

omega Greek letter, used in its capital form to represent the word ohms, and in its lower-case form as a letter symbol for a value equal to 6.28 times frequency ($2\pi f$).

omnidirectional In all directions.

omnigraph An instrument for producing Morse code messages for instruction purposes, containing a buzzer circuit actuated by a perforated tape or other means.

ondograph An instrument for drawing alternating wave-form curves with a

step-by-step method in which a capacitor is charged momentarily about once every hundred cycles, a little further along the wave form each time, and discharged each time into a recording galvanometer.

ondometer A frequency meter or wavemeter.

ondoscope A glow discharge tube used as an indicator of electric waves.

O network A network composed of four impedance branches connected in series to form a closed circuit.

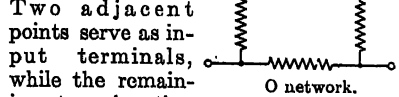

Two adjacent points serve as input terminals, while the remaining two junction points serve as output terminals.

one-way communication Transmission of messages from one station to one or more receiving stations that have no transmitting apparatus. Applied to certain radio communication systems or intercommunication systems.

on the head Starting of a radio program on scheduled time.

on the nose Ending of a radio program at exactly the scheduled second.

opacimeter An instrument for measuring the turbidity of a liquid. A photoelectric opacimeter does this by measuring the amount of light that passes through the liquid. Also called *turbidimeter*.

opacity The measurable ability of a substance to obstruct by absorption the transmission of radiant energy such as light. Opacity is thus the degree of nontransparency.

opaque 1. Not transparent, and hence not passing light rays. 2. Not passing any form of radiant energy.

open The condition in which conductors are separated so that current cannot pass.

open circuit A circuit that is not continuous.

open-circuit jack A jack that normally leaves its circuit open. The circuit can be closed only through a circuit connected to the plug that is inserted in the jack.

open-circuit voltage The voltage at the terminals of a battery or other voltage source when no appreciable current is flowing.

open core An iron core fitting inside a coil but having no external return path, so that the magnetic circuit has a long path through air.

open wire A conductor supported above the surface of the ground.

open-wire line An overhead telephone or telegraph line having each wire separately supported by insulators, as distinguished from a cable containing many wires.

operating angle The electrical angle (portion of a cycle) during which plate current flows in an amplifier or an electronic tube. Operating angles for three types of amplifiers are: class A, 360 degrees; class B, 180 to 360 degrees; class C, less than 180 degrees.

operating point That point on a grid voltage-plate current characteristic curve of a vacuum tube which corresponds to the direct voltage values being used for the grid and plate. Also called *quiescent point*.

operating power The power that is actually supplied to a radio station antenna. Maximum rated carrier power is the maximum power at which the transmitter can be operated satisfactorily, and is determined by the design of the transmitter and the type and number of vacuum tubes used in the last radio-frequency stage. Plate input power means the product of the direct plate voltage applied to the tubes in the last radio-frequency stage by the total direct current flowing to the plates of these tubes, measured without modulation. Antenna input power or antenna power means the product of the square of the antenna current and the antenna radiation resistance at the point where the current is measured.

operating voltages The direct voltages applied to the electrodes of a vacuum tube under operating conditions.

operator A person whose duties include operation, adjustment, and maintenance of a radio transmitter or other communication equipment.

opposition The condition in which the phase difference between two periodic quantities having the same frequency (period) is one-half of a cycle or period.

optical axis 1. The straight line that passes through the centers of curvature of the surfaces of a lens. Light rays passing along this direction are neither refracted nor reflected. 2. In a quartz crystal, the Z axis is the optical axis, and runs lengthwise through the mother crystal from apex to apex.

optical bench A horizontal track with a graduated scale, on which lenses and other optical devices may be temporarily mounted for measurements and/or experiments.

optical filter A selectively transparent pane of glass or similar material that transmits only certain wavelength ranges in the visible, ultraviolet, and infrared spectrums.

optical flat A piece of optical glass, usually in the form of a disk with parallel surfaces, having surfaces that have been ground and polished plane or flat to within a fraction of a wavelength of light. Used chiefly in laboratories for precision measurements and for tests of mirrors and prisms.

optically flat Departing from a true plane or flat surface only by distances that are small compared with the wavelengths of light.

optical pattern The Christmas-tree-like pattern observed when the surface of a phonograph record is illuminated by a beam of light directed parallel to the surface. This pattern indicates the frequency-response characteristics of the recording.

optical pyrometer An instrument that measures high temperatures by measuring the intensity of the light emitted

OPTICAL TWINNING

by a hot body in a particular wavelength range, usually with a photoelectric arrangement.

optical twinning A defect occurring in natural quartz crystals, in which both right quartz and left quartz occur in the same crystal. This generally results in small regions of unusable material that are discarded when cutting up a crystal.

optics That branch of science which deals with the phenomena of light and vision.

optimum The most favorable degree, condition, etc.

optimum bunching The bunching condition required for maximum output in a velocity-modulation tube.

optimum coupling The degree of coupling that provides maximum transfer of signal energy from one radio-frequency circuit to another. Also called *critical coupling*.

optophone An instrument that enables sightless people to read ordinary books. It involves the use of a selenium cell, a means for intermittently illuminating the letters of print in bands, and a circuit for converting the resulting signals into sounds of different pitch that after training can be recognized as letters.

orbit The path described by a particle under the influence of a gravitational or other force.

orbital electron One of the electrons that are visualized as moving in orbits around the nucleus of an atom.

order of a wave In specifying the manner of propagation of a *TM* wave (also called *E* wave) or *TE* wave (also called *H* wave) in a wave guide, the first subscript number following the letter designation gives the order of the electromagnetic wave, corresponding to the number of vibrations or half-period variations of the field along diameters of a circular wave guide or along the *x* coordinate of a rectangular guide. The second subscript numeral gives the mode of the wave, cor-

responding to the number of vibrations or half-period variations of the field in a radial direction between the center and the walls, counting the outermost (the wall or sheath) as one, or the number of vibrations along the *x* coordinate of a rectangular wave guide.

order of reflection The number of hops, from earth to ionosphere and back to earth, taken by a radio wave in traveling from one point to another.

order wire circuit A circuit used between telephone exchanges only in asking for connections. The corresponding circuit in radio broadcasting is usually called a *cuc* channel.

ordinary component That component of light which is totally reflected at the cementing layer of a nicol prism. Only the extraordinary component, which is plane polarized, passes through the prism.

ordinary ray When light is sent through a doubly refracting crystal, it is separated into two components that are at right angles to each other and are known as the ordinary ray and the extraordinary ray.

ordinary wave One of the two components into which a radio wave is divided in the ionosphere by the magnetic field of the earth. Sometimes called the *O* wave. The other component is the extraordinary wave, or *X* wave.

ordinate The value that specifies distance in a vertical direction on an ordinary graph.

Orgatron An electronic musical instrument in which vibrations of brass reeds are converted by electrical means into organ tones.

orient To rotate or otherwise adjust with respect to some reference.

origin 1. The point of intersection of the reference axes on a graph. 2. That reference from which anything begins.

orioscope An instrument for locating the electrical axes of a quartz crystal

and determining their sense. The surface of the crystal section is etched with hydrofluoric acid, and concentrated white light is then passed through the crystal and refracted from the upper etched surface. The refracted light forms a three-arm pattern of light, with each arm approximately along one of the electrical axes. Accurate determination of the electrical axes is then made with an X-ray goniometer.

orthicon An orthiconoscope.

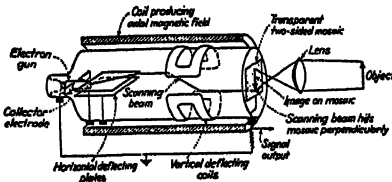

Simplified diagram showing the construction of one type of orthiconoscope (also called orthicon) for television cameras.

orthiconoscope An improved form of the iconoscope television camera tube, having an inherent storage efficiency of 100 per cent. It employs low-velocity electrons for scanning. Sometimes called *orthicon*.

orthochromatic Having equal sensitivity to all colors. In practice, however, the term usually indicates only that the material is sensitive to green as well as to shorter wavelengths.

oscillating current A current that alternately increases and decreases in magnitude with respect to time according to some definite law. Examples are periodic current and alternating current.

oscillating quantity A quantity that, as a function of some independent variable such as time, alternately increases and decreases in value, always remaining within finite limits.

oscillation That state of a physical quantity in which, in the time interval under consideration, the value of the quantity is continually changing in such a manner that it passes through maxima and minima. Examples are an oscillating pendulum and an alter-

nating current. Also called vibration, though this is more properly applied to a mechanical system in which the motion is in part determined by elastic properties.

- oscillator** 1. Any nonrotating device for setting up and maintaining oscillations of a frequency determined by the physical constants of the system, such as a vacuum tube, spark, or arc generator. 2. In a superheterodyne receiver, that stage which generates a radio-frequency signal of the correct frequency to mix with the incoming signal and produce the intermediate-frequency value of the receiver. 3. In a transmitter, the stage that generates the carrier frequency of the station or a frequency equal to some definite fraction of the carrier frequency. 4. A test instrument that can be set to generate an unmodulated or tone-modulated radio-frequency signal at any frequency needed for aligning or servicing radio receivers and amplifiers. Also called *all-wave oscillator*, *all-wave signal generator*, *signal generator*, or *test oscillator*. 5. A test instrument for generating an audio-frequency signal at any desired frequency for test purposes.

oscillator coil The radio-frequency transformer used in the oscillator circuit of a superheterodyne receiver or in other oscillator circuits to provide the feedback required for oscillation.

oscillator harmonic interference Interference occurring in a superheterodyne receiver due to the interaction of incoming signals with harmonics (usually the second harmonic) of the local oscillator.

oscillator-mixer-first detector A single stage used in a superheterodyne receiver to provide the functions of the local oscillator and the mixer-first detector. It usually employs a pentagrid converter tube.

oscillator padder An adjustable capacitor used in series with the oscillator tank circuit of a superheterodyne receiver to permit adjusting the tracking between the oscillator and preselector at the low-frequency end of the tuning dial.

OSCILLATORY CIRCUIT

oscillatory circuit A circuit containing inductance, capacitance, and resistance so arranged or connected that a voltage impulse will produce a current that periodically reverses.

oscillatory discharge An alternating current of gradually decreasing amplitude which, under certain conditions, flows through a circuit containing inductance, capacitance, and resistance when a voltage is applied.

oscillatory surge A surge (transient electric variation) that includes both positive and negative polarity values. A unidirectional surge is called an impulse.

oscillogram The recorder trace or permanent record produced by an oscillograph.

oscillograph An apparatus for producing a graphic record representing the instantaneous values of a rapidly varying electric quantity as a function of time or of some other electric quantity. An instrument that shows this same information on a cathode-ray tube screen without producing a record of it is more properly called an oscilloscope, although a few engineers use these two terms interchangeably.

oscilloscope An apparatus for showing visually on the screen of a cathode-ray tube the waveform of a rapidly varying quantity such as an alternating voltage.

osophone A telephone receiver for use by practically deaf persons. It applies sound vibrations directly to the bones of the head.

Oudin current A high-frequency current having very high voltage, used in electrobiology.

Oudin resonator A coil of wire with an adjustable number of turns, designed to be connected to a source of high-frequency current such as a spark gap or induction coil, for the purpose of applying a high-voltage discharge to a patient undergoing electrotherapy.

outdoor antenna A radio receiving antenna erected outside a building, usually in an elevated location.

outlet A point on a wiring system at which current can conveniently be taken for fixtures, lamps, appliances, etc.

out of phase Having waveforms that are of the same shape but do not pass through corresponding values at the same instants.

output The useful electrical energy or other form of energy delivered by a circuit or device.

output capacitance The sum of the direct capacitance between the output electrode (usually the plate) and the cathode and such other electrodes as are operated at the alternating potential of the cathode of the vacuum tube.

output impedance The impedance as measured between the output terminals of a circuit or device at a particular frequency. For maximum transfer of energy, the load impedance should match the output impedance.

output indicator A meter or other device connected to a radio receiver to indicate variations in output signal strength for alignment and other purposes without measuring the exact value.

output meter An alternating-current voltmeter connected to the output of a receiver or amplifier in order to measure output signal strength.

output meter adapter A device that can be slipped over the plate prong of the output tube of a radio receiver to provide a conventional terminal to which an output meter can be connected during alignment.

output stage The final stage in any electronic equipment. In a radio receiver, it feeds the loudspeaker directly or through an output transformer. In an audio-frequency amplifier, it feeds one or more loudspeakers, the cutting head of a sound recorder, a transmission line, or any other load.



Radio outlet.

In a transmitter, it feeds the transmitting antenna.

output transformer The iron-core audio-frequency transformer used to match the output stage of a radio receiver or audio-frequency amplifier with its loudspeaker or other load. It is often mounted on the loudspeaker.

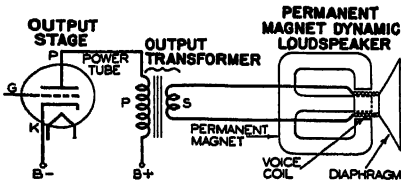

Output transformer connections in a single-tube stage.

output tube A power-amplifier tube designed for use in an output stage.

overbunching The condition existing when the buncher voltage of a velocity-modulation tube is more than the value required for optimum bunching of electrons.

overcompounding In a compound-wound generator the use of sufficient series turns to cause a rise in voltage as the load increases, in order to compensate for increased line drop. In a motor, overcompounding causes the speed to increase as the load increases.

overcutting Recording at an excessively high signal level, so that adjacent grooves touch at some points.

overdamping Any case of aperiodic damping in which the amount of damping is greater than that required for critical damping.

overdriven amplifier An amplifier designed to distort the input signal waveform by a combination of cutoff limiting and saturation limiting.

overlap The amount by which the effective height of the scanning spot in a facsimile system exceeds the nominal width of the scanning line.

overload A load greater than that which a device is designed to handle.

overload capacity The amount of overload a device can handle without undergoing permanent damage.

overload protection Protection against excessive current by means of a device that automatically interrupts current flow to the device so protected.

overload relay A relay that functions when current flow in a circuit exceeds the normal value.

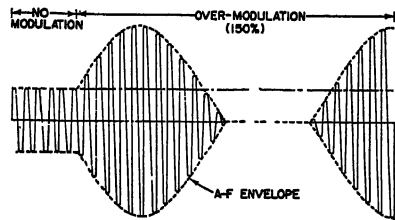

Overmodulation.

overmodulation Amplitude modulation greater than 100 per cent, causing distortion because the carrier voltage is reduced to zero during portions of each cycle.

overshoot distortion Overthrow distortion.

overthrow distortion In facsimile, the distortion resulting when the maximum amplitude of the signal wave front exceeds the steady-state amplitude of the signal wave. Also called *overshoot distortion*.

overtone One of the harmonic frequencies at which a vibrating body can freely vibrate in addition to its lowest fundamental frequency.

O wave One of the two components into which a radio wave is divided in the ionosphere by the magnetic field of the earth. Sometimes called the *ordinary wave*. The other component is the extraordinary wave, or X wave.

oxide An element combined with oxygen. Rust is an oxide of iron.

oxide-coated cathode A cathode that has been coated with oxides of alkaline-earth metals to improve electron emission at moderate temperatures.

OXIDE-COATED FILAMENT

oxide-coated filament A thermionic vacuum-tube filament that has been coated with oxides of alkaline-earth metals to improve electron emission at moderate temperatures. Such filaments serve also as cathodes.

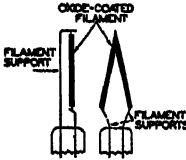

Oxide-coated filament.

oximeter A photoelectric instrument for measuring continuously the oxygen saturation of arterial blood in a person,

by photoelectric measurement of the intensity of a light beam passed through part of the ear.

oz Abbreviation for ounce.

ozone A gas produced by an electric discharge in air. It has a characteristic pungent odor. The molecular formula is O_3 , meaning that it is one and one-half times as dense as ordinary oxygen. It is also produced by strong ultraviolet radiation and other means.

ozonizer An apparatus in which ozone is produced for disinfecting or other purposes by means of a silent discharge of electricity between electrodes in air.

P

P 1. Designation for the primary winding of a transformer. 2. Designation for the anode or plate of an electron tube.

P 1. Letter symbol for power. 2. Letter symbol for permeance.

p-a Abbreviation for public address, as applied to an amplifier or other part of a public-address system.

packing Excessive crowding of carbon particles in a carbon microphone, due to excessive pressure or to fusion of particles due to excessive current, and causing lowered resistance and sensitivity.

pack unit A term often applied to a compact combination radio transmitter and receiver that can be carried or strapped on the back. Some pack units are popularly known as walkie-talkies.

pad A nonadjustable transducer (energy-transferring device) for reducing the amplitude of a wave without introducing appreciable distortion. The corresponding adjustable device is called an attenuator.

padder The oscillator padder in a superheterodyne receiver, comprising a trimmer capacitor inserted in the oscillator tuning circuit to control calibration at the low-frequency end of a tuning range.

pallesthesiometer An instrument for applying vibration to the human body in order to test the sound transmission of body tissue. The subaqueous loudspeaker is one type.

pan To tilt or otherwise move a television camera vertically and horizontally to keep it trained on a moving object or secure a panoramic effect.

pancake coil Any flat coil, having a diameter appreciably greater than its length.

pancake turner A person who operates a transcription turntable in a broadcasting studio.

panchromatic Sensitive to all wavelengths within the visible spectrum, though not uniformly so.

panel A metallic or nonmetallic sheet on which the operating controls of a receiver, transmitter, or other electronic or electric units are mounted.

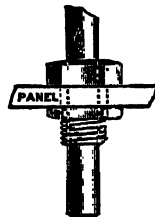

Panel bearing.

panning Moving a television camera in either vertical or horizontal planes or a combination, to keep a moving object in the picture or secure a panoramic effect.

panoramic receiver A radio receiver that permits continuous observation on a cathode-ray tube screen of the presence and relative strength of all signals within a wide frequency range above and below the frequency to which the receiver is tuned. Used in communications for monitoring a wide band, for locating open channels quickly, for indicating intermittent signals or interference, or for monitoring a frequency-modulation transmitter.

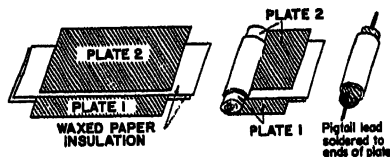

Construction of paper capacitors.

paper capacitor A fixed capacitor consisting of two strips of metal foil separated by oiled or waxed paper or other insulating material, and rolled together in compact tubular form. The foil strips are staggered so one projects

PARABOLIC MICROPHONE

from each end of the roll, and the connecting wires are attached to the projecting foil strips.

parabolic microphone A microphone positioned at the focus of a parabolic sound reflector to give highly directional characteristics, such as are required for picking up a band marching down a football field.

parabolic reflector A reflector that brings distant parallel rays to a focus at a point, or produces a parallel beam when a light source is placed at its focus.

para-curve A loudspeaker diaphragm having a parabolic shape, used to secure piston action whereby the entire cone moves as a unit. Sometimes called *curvilinear cone*.

paraffin A vegetable wax having fairly good insulating and dielectric properties.

parallax The apparent displacement of the position of an object caused by a shift in the point of observation. Thus, the pointer of a meter will appear to be at different positions on the scale depending on the angle from which the meter is read. To eliminate errors in meter reading due to parallax, the eye should be directly above the meter pointer.

parallel 1. Connected to the same pair of terminals, so that current branches out over two or more paths. 2. The condition in which two lines or surfaces extending in the same direction are equally distant at all points.

parallel beam A beam consisting of light rays that are exactly parallel to each other.

parallel connection A connection of two or more parts to the same pair of terminals so that current divides between the parts, as contrasted to a series connection in which parts are connected end to end so that the same current flows through all parts.



Parallel connections of dry cells.

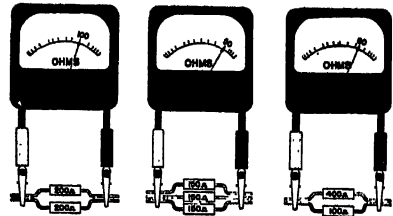

Examples of parallel resistance.

parallel cut A Y cut in a quartz crystal.

parallel feed Shunt feed, in which the direct operating voltage is applied to the grid or plate of a vacuum tube through a choke coil that blocks signal currents, with signal currents taking a separate path through a capacitor to the load.

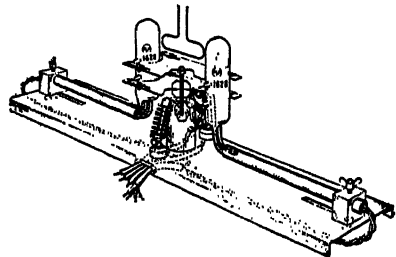
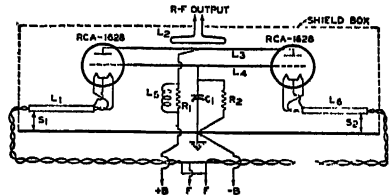

Parallel-plate ultrahigh-frequency-oscillator circuit for generating 10 to 15 watts of useful power at about 650 megacycles, and actual arrangement of tubes and parts.

parallel-plate oscillator A push-pull ultrahigh-frequency oscillator circuit making use of two parallel plates as the main frequency-determining elements. Two type 1628 tubes in this circuit will deliver 10 to 15 watts of useful power at 650 megacycles.

parallel resonance The steady-state condition that exists in a circuit comprising inductance and capacitance connected in parallel, when the inductive and capacitive reactance values are equal. The current entering the

circuit from the supply line is then in phase with the voltage across the circuit.

parallel resonant circuit A resonant circuit comprising an inductor and capacitor connected in parallel to a voltage source. At resonance (when the inductive reactance equals the capacitive reactance) the circuit has a high impedance, and a high signal voltage value is developed across it at the frequency to which the circuit is resonant.

parallel-rod oscillator An ultrahigh-frequency oscillator circuit in which parallel rods of wires of required length and dimensions form the tank circuits.

parallel-rod tank circuit A tank circuit consisting of two parallel rods connected at their far ends, providing the small values of inductance and capacitance in parallel that are required for ultrahigh-frequency circuits.

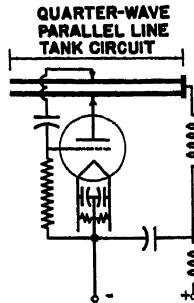

Parallel-rod tank circuit in ultrahigh frequency oscillator.

parallel-rod tuning A tuning method sometimes used at ultrahigh frequencies, in which the position of a sliding shorting bar on two parallel rods is varied for the purpose of tuning the transmitter, receiver, or oscillator.

paramagnetic Having a magnetic permeability greater than that of a vacuum and essentially independent of the magnetizing force. In ferromagnetic materials, the permeability varies with magnetizing force.

parameter 1. One of the constants entering into a functional equation, and corresponding to some characteristic property, dimension, or degree of freedom. 2. One of the resistance, inductance, mutual inductance, or capacitance values involved in a circuit or network. Also called *network constant*.

paraphase amplifier An amplifier that converts a single input circuit into a push-pull output circuit.

parasitic element An antenna element that receives excitation by induction or direct radiation from the driven element and reradiates the energy in the proper phase relationship to provide the desired directional characteristics.

parasitic oscillations Unintended self-sustaining oscillations at a frequency different from the operating frequency, occurring chiefly in vacuum-tube circuits.

parasitic suppressor A combination of inductance and resistance, usually in parallel, inserted in the grid circuit of a radio-frequency amplifier stage to suppress parasitic high-frequency oscillations.

particle Any very small part of matter, such as a molecule, atom, or electron.

particle velocity The instantaneous velocity of a given infinitesimal part of a medium, with reference to the medium as a whole, due to the passage of a sound wave.

Paschen's law The sparking potential between two given terminals in a given gas is proportional to the product of the pressure and the spark length. For a given voltage, this means that spark length is inversely proportional to pressure.

passive electric network An electric network containing no source of energy.

passive transducer A transducer containing no source of power.

paste A medium in the form of a paste or jelly containing an electrolyte. It is positioned adjacent to the negative electrode of a dry cell. In an electrolytic cell, the paste serves as one of the conducting plates.

patch A temporary connection of broadcast studio equipment.

patch board A board or panel having a number of jacks at which circuits are terminated. Short cables called patch cords are plugged into the jacks to

PATCH CORD

connect various circuits temporarily as required in telephone, broadcast, and communications work.

patch cord A cord equipped with plugs at each end, used to connect two jacks on communications switchboards or similar switchboards used in radio stations.

patent A document conferring on an inventor for a term of years the exclusive right to make, use, and sell his invention in practical form. It is based on evidence of priority of creative conception, protects from the date the patent is allowed, but does not protect during the period a patent is pending or before an application is made.

pathometer An instrument for testing mental reaction by determining how skin resistance changes with the application of an external voltage to electrodes in contact with the skin. It requires a high-gain stabilized direct-current amplifier. Also called *psychogalvanometer*.

pattern A means of specifying the character of a wave in a guide by showing the loops of force existing in the guide for that wave. The pattern identifies the order and the mode of the wave and the cross-section shape of the guide.

Pb Chemical symbol for lead.

PBX Abbreviation for private branch telephone exchange.

peak The maximum instantaneous value of an alternating quantity.

peak forward anode voltage The maximum instantaneous anode voltage in the direction in which an electron tube is designed to pass current.

peaking circuit A type of circuit that converts an input voltage into a peaked output waveform.

peak inverse anode voltage The maximum instantaneous anode voltage in the direction opposite to that in which an electron tube is designed to pass current.

peak load The maximum load consumed or produced in a stated period of time. It may be the maximum instantaneous load or the maximum average load over a designated interval of time.

peak plate current The maximum instantaneous plate current flowing in a tube.

peak response Maximum response.

peaks Momentary high volume levels occurring during a radio program and causing the volume indicator at the studio or transmitter to swing upward.

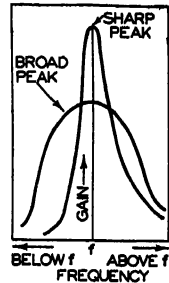

peak-signal level An expression of the maximum instantaneous signal power or voltage, including auxiliary signals, as measured at any point in a facsimile system.

Peak response curves of an intermediate-frequency amplifier.

peak sound pressure The maximum absolute value of the instantaneous sound pressure during any specified time interval, expressed in dynes per square centimeter. Called maximum sound pressure when the time interval is one cycle.

peak value The maximum instantaneous value of an alternating quantity.

peak voltmeter A voltmeter that reads peak values of an alternating voltage.

pea lamp An incandescent lamp having a bulb about the size of a pea, used medically for inspection purposes, for indicating purposes on panels, and in small flashlights.

pedestal The constant voltage value existing in a television signal just before and after transmission of synchronizing impulses.

pedestal level A reference direct-voltage value added to the video signal produced by the television camera tube. Synchronizing impulses swing the

signal in one direction from the pedestal level, while picture signal elements swing the signal in the other direction by an amount that is proportional to the brightness of the element being scanned.

Peltier effect The production or absorption of heat at the junction of two metals when a current is passed through the junction. Heat generated by current in one direction will be absorbed when the current is reversed. The rate is proportional to the current. Discovered by Jean C. A. Peltier, French physicist.

Peltier electromotive force That component of the voltage produced by a thermocouple which is due to heat produced by the Peltier effect at the junction of the different metals. It adds to the Thomson electromotive force to produce the total voltage of the thermocouple.

penetration frequency The frequency, for an ionized layer of the ionosphere, at which the virtual height for a wave component at vertical incidence has a maximum value corresponding to penetration of the wave through the layer. Except for sporadic and scattered reflections, it is the highest frequency at which a radio wave traveling vertically upward will be reflected from the layer. At higher frequencies, the radio waves will penetrate the layer. Also called *critical frequency*.

penetrometer An instrument for indicating the hardness (penetrating ability) of X rays. Also called *qualimeter*.

penetron A particle having the same unit negative charge as an electron but a mass intermediate between that of the electron and the proton. Produced by cosmic radiation impinging on gas molecules, or actually forming a part of cosmic rays. Also called *barytron*, *dynatron*, *heavy electron*, *mesotron*, *X particle*, etc.

pentagrid converter A pentagrid tube used as a converter in a superheterodyne receiver.

pentagrid tube A tube having five grids. It is often called a pentagrid converter tube because its chief use is as a converter (oscillator-mixer-first detector) in superheterodyne receivers.

pentatron A five-electrode vacuum tube having one cathode, two grids, and two anodes, designed to provide push-pull amplification with a single tube.

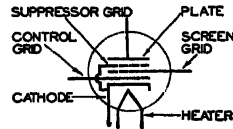

Pentode symbol.

pentode A five-electrode vacuum tube containing an anode, a cathode, a control electrode, and two additional electrodes ordinarily in the nature of grids.

percentage bridge A type of slide-wire bridge designed so a change of 0.01 per cent in the ratio of the two resistances being compared requires a change of one division of the slide scale for balancing.

percentage modulation 1. In amplitude modulation, the ratio of half the difference between the maximum and minimum amplitudes of an amplitude-modulated wave to the average amplitude, expressed in per cent. 2. In frequency modulation, the ratio of the actual frequency swing to the frequency swing required for 100 per cent modulation, expressed in percentage. (For high-frequency broadcast stations, a frequency swing of 75 kilocycles was originally standard for 100 per cent modulation.) 3. The modulation factor multiplied by 100 to express it as a percentage.

percentage modulation meter An instrument used to measure the percentage of modulation of an amplitude-modulation transmitter. Some types contain a cathode-ray tube, while others use a meter for indicating purposes.

per cent ripple The ratio of the effective value of the ripple voltage of a rectifier or generator to the average value of the total voltage, expressed in per cent.

PERCUSSIVE WELDING

percussive welding A resistance welding process utilizing welding energy suddenly discharged. The two types in use are electrostatic and electromagnetic percussive welding.

perfect dielectric A dielectric in which all the energy required to establish an electric field in the dielectric is returned to the electric system when the field is removed. A vacuum is the only known perfect dielectric.

peridyamic loudspeaker A box-type loudspeaker baffle designed to give good bass response by minimizing acoustic standing waves.

peridyne reception An early system of radio reception in which one part of the circuit was an inductor enclosed in a metal case having a movable screen that provided a fine adjustment of inductance.

perikon detector A rectifier-type detector employing two mineral crystals in contact, such as a point of bornite in contact with a mass of zincite.

perimeter The distance around a closed curve. In the case of a circle, it is called the circumference.

period The time required for one complete cycle of a periodic (oscillating or recurring) quantity.

periodic antenna An antenna in which the impedance varies as the frequency is altered, due to reflections or standing waves within the antenna system. Open-and wires and resonant antennas are examples.

periodic current An oscillating current whose values recur at equal intervals of time.

periodic damping Damping in which the pointer of an instrument oscillates about the final position before coming to rest. The point of change between periodic and aperiodic damping is called critical damping.

periodic law The law that certain properties of the elements are periodic functions of their atomic numbers. When the elements are arranged in the order of their atomic numbers, these properties recur in regular cycles.

periodic line A line consisting of successive identically similar sections, similarly oriented, the electrical properties of each section not being uniform throughout. An example is a loaded line with loading coils uniformly spaced.

periodic quantity An oscillating quantity whose values recur for equal increments of the independent variable (usually time).

periodic resonance Resonance in which the period or frequency of the applied agency maintaining oscillation is the same as the natural period of oscillation of a system. Also called *natural resonance*.

periodic table A table of elements arranged according to the periodic law, first presented by Mendelyceev, in which elements with similar characteristics are logically grouped together.

periodic wave A wave in which the displacement at each point of the medium is a periodic (alternating) function of time or distance, or both.

peripheral electron One of the outer electrons of an atom, supposed to be responsible for visible light, thermal radiation, and chemical combination. Also called *valence electron*.

Permalloy An alloy having high magnetic permeability, usually consisting of iron, nickel, and small quantities of other metals.

permanent magnet A piece of hardened steel or other magnetic material that has been strongly magnetized and retains its magnetism indefinitely.

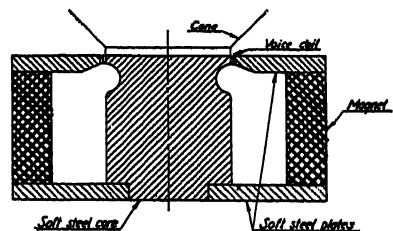

Cross-hatched area indicates the ring-shaped permanent magnet used in one type of permanent-magnet dynamic loudspeaker.

permanent-magnet dynamic loudspeaker A dynamic or moving-coil loudspeaker in which the magnetic field is provided by a permanent magnet.

permanent-magnet moving-coil instrument A meter that depends for its operation on the reaction between the current in a movable coil and the magnetic field of a fixed permanent magnet.

permanent-magnet moving-iron instrument A meter that depends for its operation on a movable iron vane that aligns itself in the resultant field of a permanent magnet and an adjacent current-carrying coil.

permatron A thermionic vacuum tube in which the control of plate current is effected by a magnetic field instead of a grid, somewhat as in a magnetron.

permeability A measure of how much better a given material is than air as a path for magnetic lines of force. The permeability of air is assumed as 1. Permeability is measured as the ratio of magnetic induction to magnetizing force, and is designated by μ (Greek letter mu). In ferromagnetic material the permeability may be as high as 5,000 or more, and may vary with magnetic intensity because of saturation. In paramagnetic material, the permeability is essentially independent of magnetic intensity.

permeability tuning Tuning of a resonant circuit by moving a pulverized iron core in or out of a coil, thereby changing the inductance of the circuit. It eliminates the need for variable capacitors, and is used in some push-button tuning assemblies.

permeameter An instrument for measuring the magnetic flux or flux density produced in a test specimen of ferromagnetic material by a given magnetic intensity, to permit computation of the magnetic permeability of the material.

permeance The magnetic flux in a portion of a magnetic circuit, divided by the magnetomotive force acting on that portion. Designated by P . It is the reciprocal of reluctance.

Perminvar One of a series of alloys of iron, nickel, and cobalt having constant magnetic permeability at different magnetic intensities. The magnetic induction of Perminvar is therefore proportional to the magnetizing force.

permittance An obsolete term for capacitance.

permittivity That property of a dielectric material that determines how much electrostatic energy can be stored per unit volume when unit voltage is applied. In effect, it is the ratio of the capacitance of a capacitor filled with a given dielectric to that of the same capacitor having only a vacuum as dielectric. Also called *dielectric constant* and *specific inductive capacitance*.

persistence An operating characteristic of a phosphor used in the luminescent screen of a cathode-ray tube, indicating how fast the radiated light disappears after the excitation is removed. If the rate of the decay is very rapid, appearing instantaneous to the eye, the phosphor is fluorescent. If the decay is slow enough to show a noticeable persistence of radiated light after excitation is removed, the phosphor is phosphorescent.

persistence of vision The effect by which we continue to see an object or image for a fraction of a second after it has disappeared. This phenomenon makes it possible to see true continuous motion by watching a series of individual pictures produced on a television or movie screen.

petoscope A photoelectric apparatus for detecting movement of persons or objects by projecting an image on two complementary checkered screens. These screens are viewed by phototubes in such a way that movement of the image upsets the balance of light.

petticoat insulator An insulator having an outward-flaring lower part that is hollow inside, to increase the length of the surface leakage path and keep part of the path dry at all times.

pf Abbreviation for power factor.

phanotron A hot-cathode gas-discharge tube in which no means is provided for controlling the unidirectional current flow. A type 866 mercury-vapor rectifier tube is a familiar example.

phantom circuit A superposed circuit (additional channel) derived usually from either two two-wire circuits or two four-wire circuits, all circuits being suitable for simultaneous transmission of currents in the same frequency range.

phase A quantity that specifies a particular stage of progress in any recurring operation such as a vibration or an alternating current. Phase is often expressed as an angle or part of a cycle, in which case the complete cycle of operation is equal to 360 degrees (one complete rotation). When two alternating quantities pass through corresponding zero values at the same time, they are said to be in phase.

phase advancer Any apparatus used to improve the power factor of an inductive load. In one type used for induction motors, it supplies a current component to the rotor at a frequency corresponding to the slip.

phase angle The phase difference between corresponding stages of progress in two cyclic operations (such as between the applied voltage and the current in an inductive alternating-current circuit), expressed as an angle. The terms lag and lead are used to specify which of the two quantities is first in time. The angle is expressed in degrees (one cycle equals 360 degrees) or in radians (one cycle equals 6.28 or 2π radians).

phase constant The imaginary part of the propagation constant. Also called *wavelength constant*. The real part is the attenuation constant.

phase delay In the transfer of a single-frequency wave from one point to another in a system, the time of delay of a peak or other recognizable part of a wave.

phase difference The fractional part of a period or cycle (not greater

than one-half) through which one of two sinusoidal (alternating) quantities must be assumed to be advanced with respect to the other in order that similar values of the fundamental components of the two quantities shall coincide.

phase distortion Distortion of received signals due to unequal phase shifts occurring in a circuit for different components of the frequency band being handled. Phase distortion is not ordinarily important in radio, but is highly important in television.

phase indicator An instrument that tells when two alternating-current generators are in phase or in synchronism. It is used when connecting an additional generator into a power system.

phase inverter A vacuum-tube stage having as a chief function the changing of the phase of a signal by 180 degrees, so that a following push-pull amplifier stage may be properly fed without using a coupling transformer. The inverter tube may also provide amplification.

phase meter An instrument for measuring the difference in phase between two alternating quantities of the same frequency.

phase modulation A method of modulating a carrier-frequency current by causing the phase of the modulated signal (with respect to the unmodulated carrier) to vary from instant to instant in accordance with the audio-frequency or other modulation signal. The power output of the transmitter is constant at all times, resulting in relatively high efficiency.

phase-modulation transmitter A radio transmitter that transmits a phase-modulation wave.

phase-modulation wave A sinusoidal wave in which the argument contains a term whose waveform is similar to that of the signal to be transmitted.

phaser In facsimile, a device for adjusting the equipment so that the recorded elemental area bears the same

relation to the record sheet as the corresponding transmitted elemental area bears to the subject copy in the direction of the scanning line.

phase resonance Resonance in which the angular phase difference between the fundamental components of the oscillation and the applied agency is 90 degrees. Sometimes called *velocity resonance* or *simple resonance*.

phase reversal A change of one-half cycle or 180 degrees in phase.

phase shift A change in the phase relationship between two alternating quantities.

phase-splitting circuit A circuit that produces from the same input waveform two output waveforms that differ in phase from each other.

phase velocity 1. An illusion that wave peaks travel through a wave guide faster than the speed of light. It appears because the elementary waves travel at an angle to the walls of the guide. The true speed is group velocity. In the caterpillar analogy, the caterpillar itself moves at group velocity, while the little waves rippling along his back from tail to head illustrate phase velocity. 2. The velocity with which a point of a certain phase in an electromagnetic wave travels in the direction of propagation.

phase wave A wave or wave group assumed in wave mechanics to be associated with an elementary moving particle such as an electron or a proton. Usually called *de Broglie wave*.

phasing In facsimile, adjustment of the picture position along the scanning line.

phasing line That portion of the length of scanning line set aside for the phasing signal in a facsimile system.

phasmajector A special vacuum tube used to produce a television signal from a fixed image for test purposes. The image is printed on the signal plate inside the tube. Also called *monoscope*, *monotron*, etc.

phenolic material A thermosetting plastic material available in many different types, any of which may be compounded with fillers and reinforcing agents to provide a broad range of physical, electrical, chemical, and molding properties for industrial applications. Molded phenolics are used for radio-receiver housings, motor housings, switch boxes, bearings, cams, etc. Laminated phenolics are used for gears, bearings, and for electronic parts requiring good insulating characteristics.

phenomena Plural of phenomenon.

phenomenon 1. Any fact or event that has scientific interest, particularly an event that illustrates the operation of some general law. 2. A fact or event that is rare or that has unique scientific significance.

phi The Greek letter ϕ , often used to designate magnetic flux or some other quantity.

Phillips screw A screw having in its head a recess in the shape of an indented cross, instead of the conventional slot. It is inserted or removed with a special Phillips screw driver that automatically centers itself in the screw.

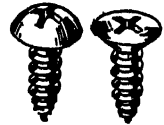

Phillips screws.

phon A unit of loudness based on the average human ear, in which the ticking of an average-priced watch 3 feet away registers 30 phons and a truck engine 90 phons.

phonograph An early device for recording the waveform of a sound. Now little used.

phone A headphone, used in radio communications to convert audio-frequency signals into sounds. Usually worn as a pair, one for each ear.



Phone plugs and jacks.

PHONIC WHEEL

phonic wheel A synchronous motor geared to a revolution counter used to measure the frequency of the alternating or interrupted current that drives it. Also, in certain synchronous multiplex systems, either of two wheels, one at the receiving station and the other at the sending station, which rotate synchronously because they are energized by the same alternating current. Modern synchronous electric clocks are in a sense phonic wheels.

phono adapter A device that slips under a tube or is otherwise connected to a radio receiver, and provides terminals to which an electric phonograph pickup can be connected so as to utilize the audio-frequency system and loudspeaker of the receiver for reproduction of phonograph records.

phonocardiogram A graphic recording of the sounds of the heart.

phonodeik An apparatus that photographically records the waveform of a sound on a moving film. Sound waves acting on a glass diaphragm cause a tiny mirror to oscillate and reflect a beam of light back and forth across moving film.

phonoecardiograph An electronic medical instrument employing a double-beam cathode-ray oscilloscope to show the waveforms of any two of the following simultaneously on a fluorescent screen: (a) heart sounds, (b) electric variations of the heart, (c) pulse variations. It also contains heart-sound amplifiers and microphones arranged with an electrical stethoscope to permit instant change-over from one listening point to another on a person for comparison purposes, with provisions for filtering out various frequency components at will.

phonograph An instrument for converting the sound groove variations of a phonograph record into sound waves. In an electric phonograph, the needle movements in the record grooves are converted into audio-frequency currents and amplified sufficiently for reproduction by a loudspeaker. In mechanical phonographs, the needle actuates a sound-producing

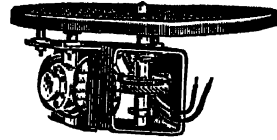

Phonograph motor.

diaphragm directly. In either type, the turntable on which the record is placed may be driven by an electric motor or a spring motor. Some electric phonographs are also equipped for use as sound recorders.

phonograph amplifier An audio-frequency amplifier designed to amplify the audio-frequency output signal of a phonograph pickup.

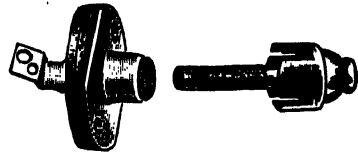

Phono jack and plug used for phonograph connections to radio receivers.

phonograph connection Two terminals sometimes provided at the rear of a radio receiver, and connected to the input of the first audio-frequency amplifier stage. When a phonograph pickup is connected to these terminals, its output is amplified by the audio-frequency amplifier and reproduced by the loudspeaker.

phonograph oscillator A radio-frequency oscillator circuit to which a phonograph pickup can be connected for modulation. The resulting modulated radio-frequency signal is fed through wires to the antenna and ground terminals of a radio receiver, so that the entire radio receiver can serve for amplifying and reproducing phonograph records. In wireless phonograph oscillators, the output is fed to a small loop antenna and broadcast through space to the radio receiver, eliminating wire connections.

phonograph pickup An electromechanical transducer (energy-transferring device) that is actuated by the variations in the grooves of a phonograph record and delivers audio-frequency

power to an electric system, with the resulting currents having essentially the same waveform as the waves in the phonograph record grooves. Examples are crystal, dynamic, and photoelectric pickups.

phonograph record A shellac-composition disk, usually 10 or 12 inches in diameter, manufactured commercially by a pressing process for home use and other entertainment purposes, and designed for playing on phonographs operating at a speed of 78 revolutions per minute.



Phonograph needles. 1, theoretically ideal but impractical because needle angle changes; 2, too sharp, allowing free movement; 3, too sharp, causing gouging; 4, too blunt, scoring groove walls; 5, best practical shape.

phonometer An instrument for measuring the intensity of a sound. The modern electronic version is the sound-level meter.

phonoscope An instrument for recording waveforms of sound. It is claimed that deaf persons can be trained to interpret such records of speech and music.

phoresis Migration of ions through a membrane by action of an electric current.

phosphor A material used in the luminescent screen of a television picture tube or cathode-ray tube. Zinc silicate, zinc sulphide, and cadmium tungstate are examples.

phosphor bronze An alloy of copper, tin, and phosphor. It is hard, springy, and nonmagnetic and is widely used for contact springs in electronic equipment, especially in relays.

phosphorescence A form of luminescence in which the emission of light continues for a time after excitation by electrons, ultraviolet light, or

X rays has ceased. When emission of light occurs only during excitation, the result is fluorescence.

phosphorescent Showing or due to phosphorescence.

phosphorogen A substance that promotes phosphorescence in another, as manganese does in zinc sulphide.

phot The unit of illumination equal to one lumen per square centimeter when the centimeter is taken as the unit of length.

photometer A photoelectric instrument used for chemical analysis, for measuring transmittances of solutions, for determining hemoglobin count, etc. One form employs a barrier-layer cell, light sources, a three-color filter holder, a microammeter connected directly to the cell for output indications, and a transparent container for the fluid being analyzed.

photocathode A cathode that emits electrons under the influence of radiant energy such as light. Used in phototubes.

photocell A photoelectric cell.

photochemical Pertaining to chemical activity produced by the absorption of radiant energy by molecules, ions, and atoms.

photochemical equivalents A principle stated by Einstein, that in photochemical action each effective light quantum is transformed entirely into chemical energy.

photoconductivity Electrical conductivity which varies with illumination due to ionization, as in gases, selenium, and some nonmetallic crystals.

photoconductive cell A light-sensitive cell whose resistance varies with the illumination on the cell. The selenium cell is an example. Photoconductive cells are usually called photoelectric cells or photocells, as they are true cells.

photodisintegration The disintegration of an atomic nucleus by the action of radiant energy.

PHOTODISSOCIATION

photodissociation The dissociation or disintegration of a chemical compound by the action of radiant energy.

photoelectric Pertaining to the electrical effects of light or other radiation. These effects can be emission of electrons, generation of a voltage, or a change in electrical resistance upon exposure to light.

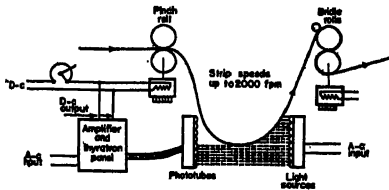

Photoelectric equipment for automatic loop control of any continuous-web process.

photoelectric abridged spectrophotometry Analysis of color by means of from three to eight spectral filters used in a simplified spectrophotometer to isolate spectral bands that make up color. The process is approximate since the bands employed are considerably wider than in true spectrophotometry.

photoelectric absorption Conversion of radiant energy into the energy of photoelectric emission.

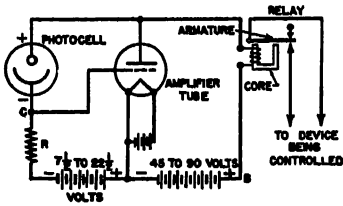

Photoelectric control circuit.

photoelectric cell A general term applying to any cell whose electrical properties are affected by illumination, such as photovoltaic or photoconductive cells. Often called *photocell*. These two terms should not be used for phototubes because they are vacuum tubes and not cells.

photoelectric colorimetry Use of photoelectric devices in any of various ways in connection with color measurements.

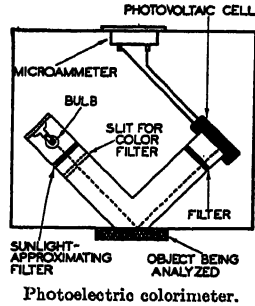

Photoelectric colorimeter.

photoelectric conductivity A property of certain crystals causing them to increase in conductivity when illuminated, as in a selenium cell.

photoelectric constant A quantity that, when multiplied by the frequency of the radiation that is causing emission of electrons, gives in centimeter-gram-second units the voltage absorbed by the escaping photoelectron. The constant is equal to h/e , where h is Planck's constant and e is the electronic charge.

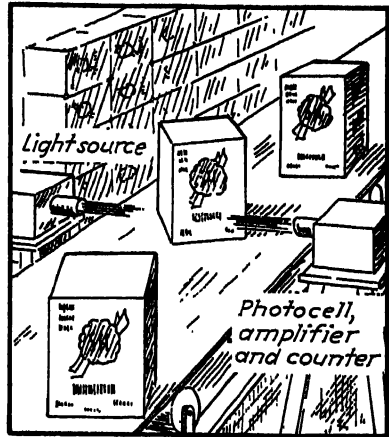

Photoelectric counter for cartons on a conveyor belt.

photoelectric counter An industrial electronic control employing a phototube or photocell and an amplifier to count objects interrupting a light beam.

photoelectric cryptometer An instrument for measuring the concealing

PHOTOELECTRIC FLAME-FAILURE DETECTOR

power of paint by measuring the difference in the amount of light reflected from a known film thickness of the paint over a white backing and over a black backing.

photoelectric current A current of electrons emitted from the cathode of a phototube under the influence of light.

photoelectric densitometer An electronic instrument used to measure the density or opacity of a material. A beam of light is directed through the material, and the amount of light transmitted is measured with a photoelectric cell and meter. In measuring the density of a photographic negative, the negative is placed between the light source and the photoelectric cell.

photoelectric door opener A photoelectric control used to actuate a hydraulic or electrical door-opening system.

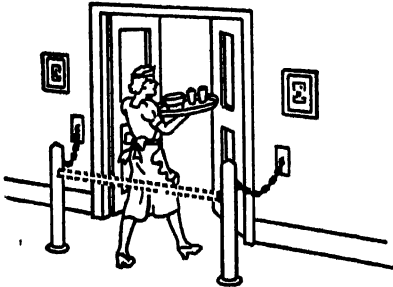

Photoelectric door-opening system.

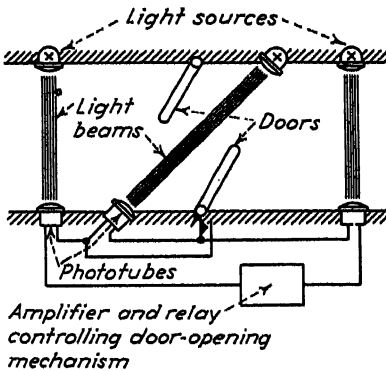

Door-opener system in which interruption of a light beam is detected by phototubes that control hydraulic or motor-driven doors.

photoelectric effect The emission of electrons from a body due to electromagnetic radiation (visible, infrared, or ultraviolet light) incident on the surface of the body. For a given material, the emission occurs only for a particular band of wavelengths of the incident radiation. For a given wavelength of incident radiation, the rate of emission of electrons is proportional to the radiant flux.

photoelectric electron-multiplier tube

A vacuum-type phototube that employs secondary emission to amplify the electron stream emitted from the illuminated photocathode. The electron stream impinges in turn on each of a series of reflecting electrodes called dynodes, at each of which secondary emission adds electrons to the stream. In one tube, an amplification of approximately 2,000,000 times is obtained with nine dynodes. Also called *electron-multiplier phototube* and *multiplier phototube*.

photoelectric emission Emission of electrons from a body under the influence of suitable radiation.

photoelectric flame-failure detector An industrial electronic control employing a phototube and amplifier to actuate an electromagnetic or other valve to cut off fuel flow when the fuel-con-

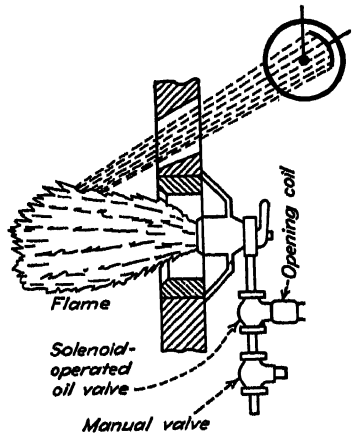

Photoelectric flame-failure detector, in which a phototube (at upper right) watches the flame continually.

PHOTOELECTRIC INSPECTION

suming flame is extinguished and no light falls on the phototube.

photoelectric inspection Quality control of a product by means of a phototube, light beam system, and associated electronic equipment.

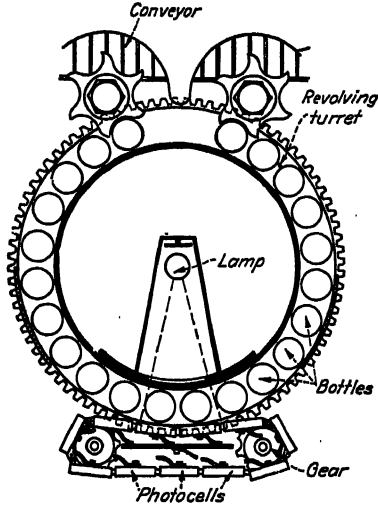

Photoelectric inspection of filled bottles of soft drinks to detect foreign ingredients. Each bottle rotates as it is moved through the light beam by the revolving turret, and a photocell moves with the bottle long enough to view its contents from all angles.

photoelectric intrusion-detector A burglar-alarm system in which interruption of a light beam by an intruder reduces the illumination on a phototube and thereby closes an alarm circuit. With steady light beams (static beam system), useful ranges of several hundred feet are readily obtained with certain types of com-

mercial equipment. In modulated-beam systems the light beam is broken up by a rotating punched or slotted disk before the beam is projected, in order to permit amplification of the phototube output. The disk used for this purpose is called an episotister. Beam ranges of several thousand feet are possible.

photoelectricity The science of photoelectric effects.

photoelectric material A material that will emit electrons when illuminated in a vacuum. Examples are barium, caesium, lithium, potassium, rubidium, sodium, and strontium.

photoelectric membrane manometer An instrument for measuring or recording very small changes in pressure, by directing a light beam on a tiny mirror attached to a membrane in the pressure system and picking up with a phototube the light reflected from the mirror.

photoelectric number sieve A device for factoring large numbers.

photoelectric phonograph pickup A phonograph reproducing device consisting essentially of a light source, a jewel stylus to which is attached a very thin mirror, and a selenium cell that picks up light reflected from the mirror. Sidewise movements of the stylus in a record groove cause the amount of reflected light to vary, and the resistance of the selenium cell varies accordingly. The light source is fed by a radio-frequency oscillator rather than from the power line, to

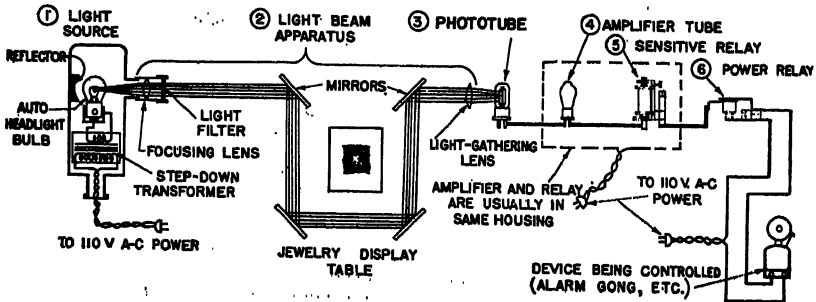

Photoelectric intrusion detector.

PHOTOELECTRIC SCANNER

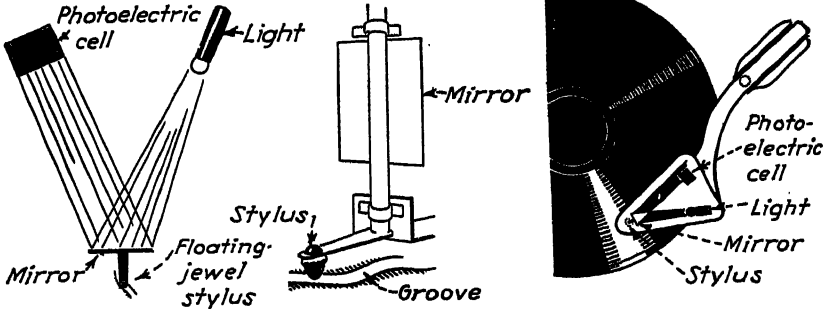

Photoelectric phonograph pickup.

eliminate 60-cycle flicker from the light beam.

photoelectric photometer A photometer in which is incorporated a phototube or photoelectric cell for measurements of light.

photoelectric plethysmograph An electronic medical instrument for recording the state of fullness of blood vessels. It measures ear opacity by means of a tiny phototube and lamp clipped to the ear. In the medical version, the phototube is connected to a direct-coupled push-pull amplifier feeding the moving coil of an inkwriter. In a commercial version used by aircraft pilots, the amplifier actuates an alarm that warns the pilot when he requires more oxygen during high-altitude flying.

photoelectric pyrometer An instrument for measuring high temperatures by measuring the intensity of the light given off by the heated object.

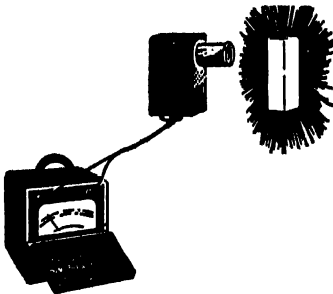

Photoelectric pyrometer for measuring the temperature of red-hot objects.

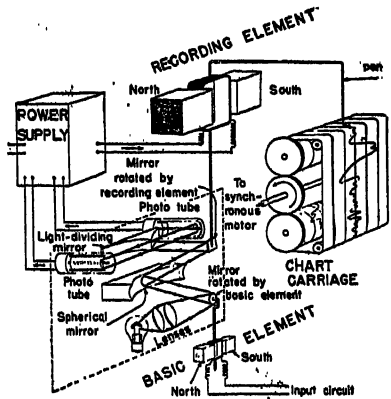

Photoelectric recorder, showing basic arrangement of parts.

photoelectric recorder A recording instrument employing a light source and phototube in an optical follow-up system for the basic measuring element, such as a galvanometer. An electronic circuit amplifies the output of the phototube sufficiently to drive the ink-writing recording system. Insertion of the electronic system between the meter and recorder provides greatly increased sensitivity and higher speed of response because there is practically no load on the measuring device employed.

photoelectric scanner A light source, lens system, and one or more phototubes in a single compact housing which can be mounted a few inches above a moving surface and used to actuate control equipment when changes occur in the amount of light reflected from the surface. These

PHOTOELECTRIC SCLEROSCOPE

changes may be due to dark areas in a printed design, to special printed register marks, or to irregularities or defects in the surface.

photoelectric scleroscope A scleroscope (instrument for measuring hardness of metals by dropping a small standard object from a fixed height and measuring the rebound) in which a phototube-light beam system is used for automatic checking of rebound height. It can be arranged so that materials which do not give sufficient rebound to intercept the light beam are automatically rejected or passed, depending on whether softness or hardness is the criterion.

photoelectric sensitivity The rate at which electrons are emitted from a metal per unit radiant flux of any given frequency. Also called *photoelectric yield*.

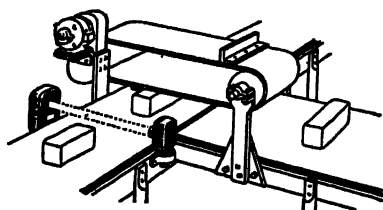

Photoelectric sorter with a motor-driven endless belt arrangement for knocking an object off the conveyor belt when the photoelectric system calls for a rejection.

photoelectric sorter An industrial electronic control employing a light beam, phototube, and amplifier to sort objects according to color, size, shape, or other characteristics.

photoelectric threshold The quantum energy just sufficient to release photoelectrons from a given surface. The corresponding frequency is the critical or threshold frequency.

photoelectric timer An electronic instrument that automatically turns off an X-ray machine when the film has reached the correct exposure. The X-ray beam passes through the subject being examined, exposes the film in a normal manner, and activates a fluorescent screen placed underneath

the film. The illumination given off by this screen, proportional to the amount of radiation reaching the film, acts on a multiplier-type phototube. When the phototube current has charged a capacitor to a predetermined value corresponding to correct exposure of the film, a thyatron trips and energizes ignitrons or relays that turn off the X-ray machine.

photoelectric tristimulus colorimeter An instrument for measuring directly the exact appearance of a material, for comparing the appearance of a material, or for comparing the colors of materials. It employs three or more combinations of light sources, filters, and phototubes so carefully designed that many thousands of different colors can be detected reliably.

photoelectric tristimulus colorimetry Evaluation of the appearance of a material by means of three or more light source-filter-phototube combinations that duplicate the standard ICI observer for colorimetry.

photoelectric tube A phototube.

photoelectric turbidimeter A photoelectric instrument used to determine the turbidity of almost clear solutions.

photoelectric work function The energy required to transfer electrons from a given metal to a vacuum or other adjacent medium during photoelectric emission. It is sometimes expressed as energy in ergs or joules per unit of emitted charge, and sometimes as energy per electron in electron-volts.

photoelectric yield Photoelectric sensitivity.

photoelectromotive force An electromotive force due to photovoltaic action.

photoelectron An electron emitted from a material under the influence of light.

photoemissive tube A phototube.

photoflood lamp An incandescent lamp using excess voltage to give brilliant illumination for television and photographic purposes. It has a life of only a few hours.

photoglow tube A gas-filled phototube used as a relay by making the operating voltage sufficiently high so that ionization and a glow discharge occur, with considerable current flow, when a certain illumination is reached.

photogoniometer An apparatus for studying X-ray spectra and X-ray diffraction effects in crystals.

photographic recording In facsimile, recording by exposure of a photosensitive surface to a signal-controlled light beam or spot.

photo-ionization Ionization occurring in a gas as a result of visible light or ultraviolet radiation.

photo-island grid The photosensitive surface in the storage-type Farnsworth dissector tube for television cameras. It comprises a thin sheet of metal having fine perforations (about 400 holes per inch in both directions).

photoluminescence Luminescence stimulated by visible light or ultraviolet radiation.

photomagnetic effect The direct effect of light on the magnetic susceptibility of certain substances.

photometer An instrument for measuring the intensity of a light source or the amount of illumination, usually by comparison with a standard light source.

photon An energy quantum of visible light or any other electromagnetic radiation.

photonegative Having negative photoconductivity, hence decreasing in conductivity (increasing in resistance) under the action of light. Selenium sometimes exhibits this property.

photoneutron A neutron emitted as a result of disintegration due to light.

photophone An instrument for transmitting sounds over short distances by means of a beam of light. The sound waves are made to modulate the intensity of the light beam at the transmitter, and a phototube with suitable

amplifiers and a loudspeaker is used at the receiver to convert the varying light beam into sound again.

phosphoresis The effect wherein very small particles (of the order of 1 micron in diameter) suspended in air can be moved by an intense beam of light. The movement can be either toward or away from the light source.

photopositive Having positive photoconductivity, hence increasing in conductivity (decreasing in resistance) under the action of light. Selenium ordinarily has this property.

photosensitive Exhibiting a photoelectric effect when irradiated, such as photoelectric emission, photoconductivity, or photovoltaic action. Also called *light-sensitive*.

phototelegraphy Transmission of photographs or other single images over a radio or wire communication system by scanning the picture into elemental areas in orderly sequence, converting each area into a proportional electric signal, transmitting the signals in sequence, and reassembling them in correct order at the receiver. Also called *facsimile*, *telephoto*, *wirephoto*, etc.

phototimer A photoelectric timer, used to turn off an X-ray machine automatically when the film has been correctly exposed.

phototube A vacuum tube in which electron emission is produced directly by radiation falling on an electrode (the

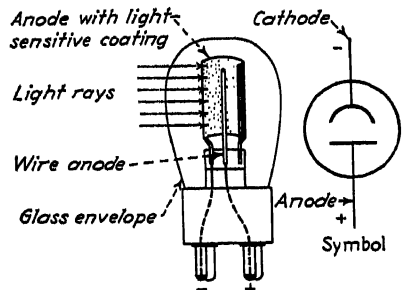

Construction of typical phototube, with example and symbol.

PHOTOVOLTAIC

cathode). The radiation may be light, infrared, or ultraviolet radiation. A phototube ordinarily has only two electrodes, the electron-emitting cathode and an anode that attracts the emitted electrons, but electron-multiplier phototubes may have several additional electron-reflecting electrodes called dynodes and a final collector electrode. A high-vacuum phototube is one that is evacuated to such a degree that its electrical characteristics are essentially unaffected by gaseous ionization. A gas phototube is one into which a quantity of gas has been introduced, usually for the purpose of increasing its sensitivity. In a gas phototube, the ionization of the gas due to electron collisions produces greatly increased plate current. Also called *light-sensitive tube* or *photoelectric tube*. The terms photocell and photoelectric cell should be used only for photovoltaic and photoconductive devices like selenium cells and copper-oxide light-sensitive cells, which are definitely not tubes.

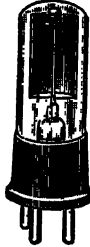

Typical phototube (type SR50).

photovoltaic Capable of generating a voltage as a result of exposure to visible or other radiation.

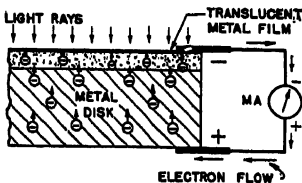

Basic construction of photovoltaic cells.

photovoltaic cell A light-sensitive cell capable of generating a voltage when exposed to visible or other radiation. Examples are the Photronic cell and the blocking-layer or barrier-layer cell (also known as a copper-oxide cell or a Photox cell).

Photox cell A type of photovoltaic cell in which a voltage is generated between a copper base and a film of cuprous oxide during exposure to visible or other radiation.

Photronic cell A type of photovoltaic cell in which a voltage is generated in a layer of selenium during exposure to visible or other radiation.

pi Greek letter π , used to designate the value 3.1416, which is approximately the ratio of the circumference of a circle to its diameter.

picking up The process of transferring a wave from a wave guide to a coaxial cable or a pair of conductors. It is the converse of the process of launching a wave into a guide.

pickup 1. A device that converts a sound, scene, or other form of intelligence into a corresponding electrical signal, such as a television camera, phonograph pickup, or microphone. 2. The location at which a radio broadcast originates. 3. The minimum current, voltage, power, or other value at which a relay will operate and complete its intended function.

picofarad Obsolete term for micro-microfarad.

pictorial wiring diagram A wiring diagram containing actual sketches of radio parts and showing clearly all connections between the parts. Used in service manuals for radio equipment and in instructions for building equipment.

picture black The signal produced at any point in a facsimile system by the scanning of a selected area of subject copy having maximum density.

picture element The smallest subdivision of a television image, arbitrarily defined by assuming equal vertical and horizontal resolution. The resulting elemental square has a dimension equal to the width of one scanning line.

picture frequency The number of complete pictures that are scanned per second in a television system. It has been standardized at 24 per second in the United States.

picture receiver A receiver for television pictures only, having no facilities for receiving the associated sound. A

set must receive both picture and sound in order to be called a television receiver, according to Radio Manufacturers Association specifications for television sets.

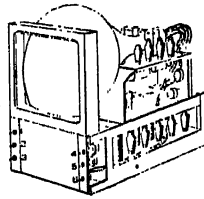

Picture receiver, with cabinet removed.

picture receiver with sound converter A receiver for television pictures, having also an incomplete sound channel that requires the use of a suitable auxiliary sound receiver.

picture signal The electrical impulses resulting from orderly scanning of successive elemental areas of a picture or scene by a television camera.

picture synchronizing impulse The impulse that controls the time at which the scanning beam in a television receiver returns from the bottom of the reproduced image to the top for the start of a new vertical sweep.

picture transmission The electric transmission, either over wires or through space by radio, of a picture having a graduation of shade values. Facsimile transmission generally involves a limited number of shade values, usually only black and white.

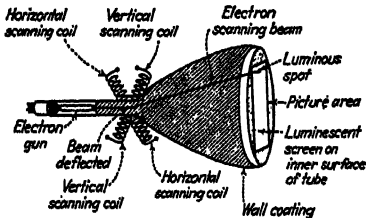

Picture tube used in a television receiver to reproduce the image point by point on a luminescent screen. This tube employs electromagnetic deflecting coils.

picture tube The image-reproducing tube in a television receiver, consisting of a funnel-shaped glass structure having in its narrow end an electron gun that produces a beam of electrons. Vertical and horizontal deflecting plates or coils cause this beam to move back and forth and up and down on the fluorescent screen at the large end

of the tube and produce there a reproduction of the scene being transmitted.

picture white The signal produced at any point in a facsimile system by the scanning of a selected area of subject copy having minimum density.

Pierce oscillator A crystal oscillator circuit in which the crystal is connected between the grid and plate of the oscillator tube. The arrangement requires no tuned plate circuit and can, therefore, be used to drive a final amplifier or a buffer stage in such a way that the transmitter has only one tuning control. A popular circuit with radio amateurs.

pie winding A method of constructing coils from a number of individual washer-shaped coils called pies.

piezodielectric Pertaining to a change in dielectric constant as a result of mechanical stress.

piezoelectric Having the ability to generate a voltage when mechanical force is applied, as to a piezoelectric crystal, or having the converse ability to produce a mechanical force when a voltage is applied.

piezoelectric axis One of the directions in a crystal in which either tension or compression will generate a voltage by causing the crystal to develop piezoelectric charges.

piezoelectric driving system A driving system in which the mechanical forces result from deformation of a crystal having converse piezoelectric properties, such as *Rochelle salts, tourmaline, and quartz*.

piezoelectric effect Generation of a voltage between opposite faces of certain crystals (such as quartz) as a result of strain due to pressure or twisting, and the reverse effect in which application of a voltage to opposite faces causes deformation to occur at the frequency of the applied voltage.

piezoelectric indicator An indicator for checking combustion pressures in internal-combustion engines. Changes in pressure on a system of quartz

PIEZOELECTRIC LOUDSPEAKER

crystals inside the cylinders are measured with thermionic voltmeters.

piezoelectric loudspeaker A loudspeaker in which the mechanical forces are obtained by the use of a piezoelectric element such as a Rochelle salt crystal.

piezoelectric microphone A crystal microphone.

piezoelectric oscillator A crystal oscillator circuit in which the frequency is controlled by a quartz crystal.

piezoelectric pickup A crystal-type phonograph pickup in which the audio-frequency output is produced across opposite faces of a piezoelectric crystal under deformation by the moving phonograph needle.

piezoelectric pressure gage An apparatus for measuring or recording very high pressures, as those in gun barrels during firing, by applying the pressure to quartz disks or other piezoelectric crystals and measuring the resulting voltage or recording it with an oscillograph after appropriate amplification.

piezoelectric resonator A plate or rod of natural quartz or other piezoelectrical crystal which may be electrically excited into resonant vibration at one or more frequencies.

piezoid Pronounced "pie-ee'-zoid."

The finished crystal product after the completion of all processes. This may include electrodes adherent to the crystal blank. Also called *finished blank*.

pigtail A highly flexible metallic connection, usually consisting of braided wire, used between a stationary terminal and a terminal having a limited range of motion, as in relay armatures.

pigtail splice A splice made by tightly twisting the bared ends of parallel conductors.

pilot cell A selected cell of a storage battery, the temperature, voltage, and specific gravity of which are assumed to indicate the condition of the entire battery.

pilot lamp A small lamp used to illuminate the tuning dial of a radio receiver (also called a *dial light*) or to indicate that electrical equipment is turned on.

pilot light A pilot lamp.

pilot spark A weak spark sometimes produced in a small spark gap in order to ionize the air and promote a more violent spark or arc in an adjacent wider gap.

pilot wire An auxiliary conductor used in connection with remote measuring



Type	Bead color	Bulb and base	Volts	Amperes
40	Brown	Tubular screw		
41	White	Tubular screw	6-8	0.15
42	Green	Tubular screw	2.5	0.50
43	White	Tubular bayonet	3.2	0.50
44	Blue	Tubular bayonet	2.5	0.50
45	Green	Tubular bayonet	6-8	0.25
46	Blue	Tubular screw	3.2	0.50
47	Brown	Tubular bayonet	6-8	0.25
48	Pink	Tubular screw	6-8	0.15
49	Pink	Tubular bayonet	2.0	0.06
49A	White	Tubular bayonet	2.0	0.06
50	White	Small globular screw	2.1	0.12
51	White	Small globular bayonet	6-8	0.20
55	White	Large globular bayonet	6-8	0.20
292	White	Tubular screw	6-8	0.40
292A	White	Tubular bayonet	2.9	0.17
			2.9	0.17

Pilot lamp identification diagrams and chart. Colored glass identifying bead is just below filament. Type 40A is exactly the same as type 47. Type 49A can be replaced with type 49. Types 43, 44, and 46 are used in tuning meters, where replacement with the correct type is particularly important.

devices (telemetering) or for operating apparatus at a distant point.

pilot-wire regulator An automatic device for controlling adjustable gains or losses associated with transmission circuits in order to compensate for transmission changes caused by temperature variations. The system usually depends on the resistance of a conductor or pilot wire having substantially the same temperature conditions as the conductors of the circuits being regulated.

pinch effect The result of an electro-mechanical force that constricts and sometimes momentarily ruptures a molten conductor carrying current at high density.

pin connections Connections made to the terminal pins at the base of a vacuum tube. The following abbreviations are used to identify pin connections: NC—no connection; IS—internal shield; IC—internal connection (but not an electrode connection); BC—base shield connection; P—plate; G—grid; SG—screen grid; K—cathode; H—heater; F—filament; RC—ray-control electrode; TA—target.

pine-tree array An array of dipole antennas aligned in a vertical plane known as the radiating curtain, with a second array parallel to and up to a quarterwavelength behind, containing corresponding half-wave antennas forming a reflecting curtain. Such an array operates at only one predetermined wavelength.

pi network A network of three impedances, two across the line and the third inserted in one line between the first two. Also written π network.

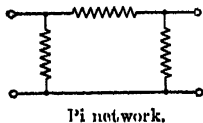

pinhole detector A photoelectric device that detects extremely small holes and other defects in moving sheets of material, and often also actuates sorting equipment that automatically rejects defective sheets.

pin jack A jack having a small opening into which can be inserted a plug hav-

ing a metal end not much thicker than a pin.

pip Popular term for a peak, protrusion, or bump on a pattern appearing on the screen of a cathode-ray tube.

piped program A radio program that has been transmitted over commercial telephone wires, usually from one studio to another.

pipe line A long metal tube having at its center a conductor supported by insulators. It is used as a transmission line for radio or television signals. Also called *coaxial cable*, *coaxial line*, *concentric line*, etc.



Pirani gage.

Pirani gage An improved hot-wire gage for measuring the degree of vacuum, based on the fact that the temperature and resistance of a filament in a gas vary with gas pressure. The lower the pressure, the hotter the filament because it cannot radiate heat so readily in a vacuum.

piston A sliding metal closure used in wave guides and in resonating cavities for tuning purposes or to provide complete reflection of waves.

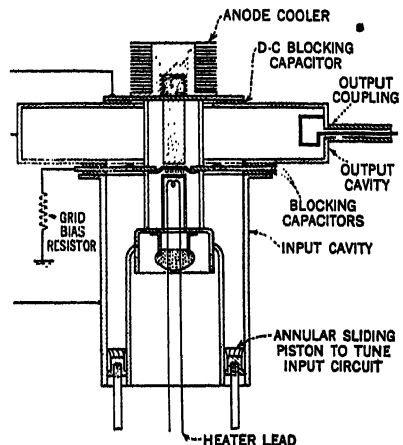

Annular sliding piston used for tuning purposes in a disk-seal tube.

PISTON ACTION

piston action The manner in which the diaphragm or cone of a loudspeaker moves when driven at low audio frequencies so the driving force is opposed only by mass and resistance, with no compliance or springiness.

pitch 1. That property of a musical tone which is determined by frequency. The higher the frequency of vibration, the higher is the pitch. 2. The distance between two successive threads of a screw.

pith ball A small ball cut from the light and spongy dried inner tissue of certain plant stalks. Used in physics experiments because of its lightness and ability to store electric charges.

pith-ball electroscope An arrangement of two small balls of pith suspended by silk threads. They show the presence of a charge in a neighboring object by moving apart owing to mutual repulsion of the charges induced in them.

Pitot tube A tube having a short right-angled bend at one end, with the open end of the bent part facing the current in a stream of water or air and with the other end connected to a manometer that responds to pressure but is calibrated to indicate the velocity of the water or air current being measured. Widely used on aircraft.

Planck-Einstein equation The equation $h\nu_{\max} = Ve$ for the conversion of electron energy into X-ray quanta, in which h is Planck's constant and ν_{\max} is the maximum X-ray frequency produced by an electron e that has acquired its energy from a voltage V .

Planck's constant A constant h appearing in many physical formulas, having the dimensions of action (energy \times time) and having a numerical value of 6.547×10^{-27} erg-second. It represents the ratio of the energy of any radiation quantum to its frequency, and was first recognized by the German physicist M. Planck in 1900. Also called *quantum of action*.

Planck's law The statement that the value of the quanta of radiation of any frequency is proportional to

the frequency and is expressed by the equation $g = h\lambda$ in which λ is the frequency and h is Planck's constant.

plane-earth attenuation The attenuation over an imperfectly conducting plane earth in excess of that over a perfectly conducting plane.

plane of a loop An imaginary plane infinite in extent, which passes through the center of a loop and is parallel to the loop wires.

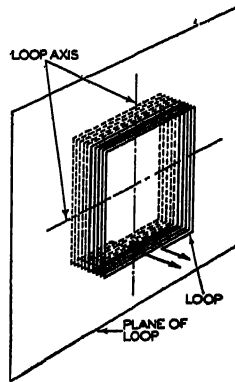

Plane of a loop.

plane of polarization The plane perpendicular to the wave front of a plane radio wave and parallel to the electric vector of the wave. In a vertically polarized wave, this plane is vertical (perpendicular to the earth). In a horizontally polarized wave, this plane is horizontal (parallel to the earth).

plane polarization Polarization in which the end of the rotating vector representing the vibrations in a beam of polarized radiation traces a straight line during each polarization cycle.

plane-polarized wave A transverse wave in which the direction of the displacement at all points in a certain space is parallel to a fixed plane parallel to the direction of propagation.

plane wave A wave whose wavefront is a plane surface.

planimeter An instrument that measures the area of any closed figure around which its pointer is moved.

PLATE RESISTANCE

Planté cell A type of lead storage cell in which the active material is formed on the plates by electrochemical means during repeated charging and discharging, instead of being applied as a prepared paste.

plasma That portion of the electric discharge in a rarified gas which contains approximately equal numbers of electrons and positive ions and hence is nearly neutral.

plasmoid A luminous region that appears in various shapes in highly exhausted tubes under excitation of very high frequency.

plastic A molded material used for making different structural shapes for radio parts as well as complete cabinets. It is now available in many different types, each having special characteristics and colors.

plate 1. Common name for the principal anode in a vacuum tube. It originally had the form of a metal plate, but now it is generally a metal cylinder surrounding the other electrodes of the tube. It is ordinarily at a high positive potential with respect to the cathode, so that it attracts the emitted electrons. 2. One of the conductive electrodes in a capacitor. 3. One of the electrodes in a storage battery. Usually a number of plates are connected in parallel to each terminal of a storage cell.

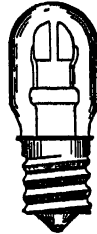

Neon pilot lamp, having two identical plates.

plate bypass capacitor A capacitor connected between the plate and cathode of a vacuum tube to bypass high-frequency currents and keep them out of the load.

plate characteristic A graph plotted to show how the plate current of a vacuum tube is affected by changes in plate voltage.

plate circuit The complete electrical circuit connected between the cathode and plate of a tube.

plate conductance The inphase component of the alternating plate current

divided by the alternating plate voltage, all other electrode voltages being maintained constant.

plate current The electron flow from the cathode to the plate inside a tube.

plate detection Detection in which rectification of the radio-frequency signals takes place in the plate circuit of a vacuum tube. The grid bias is made sufficiently negative to bring the plate current nearly to cutoff for no signal, so that the average plate current follows changes in signal amplitude.

plate dissipation The amount of power lost as heat in the plate of a vacuum tube.

plate efficiency The output power of a vacuum tube divided by direct-current input power to the plate.

plate impedance The plate-voltage change divided by the resulting plate-current change in a vacuum tube, all other conditions being fixed.

plate input power The product of the direct plate voltage applied to the tubes in the last radio stage of a transmitter and the total direct current flowing to the plates of these tubes, measured without modulation.

plate keying Keying of a radiotelegraph transmitter by interrupting the plate supply circuit.

plate load impedance The impedance at the signal frequency of the path between the plate and cathode of a vacuum tube.

plate modulation Modulation produced by introduction of the modulating wave into the plate circuit of any tube in which the carrier-frequency wave is present.

plate power supply The means for supplying power to the plate of a thermionic tube at a properly regulated voltage that is usually positive with respect to the cathode.

plate resistance The resistance in ohms of the path through space between the plate and cathode of a vacuum tube.

PLATE SATURATION

plate saturation The condition in which the plate current of a thermionic vacuum tube cannot be further increased by increasing the plate voltage. The electrons are then being drawn to the plate at the same rate as they are emitted from the cathode. Also called *current saturation* or *voltage saturation*.

plate-to-plate impedance The load impedance as measured between the two plates in a push-pull amplifier stage.

plate voltage The direct voltage that exists between the plate and cathode of a vacuum tube.

platinite An alloy of nickel and iron containing about 46 per cent nickel and having an expansion coefficient nearly equal to that of platinum. It can be used in place of platinum for lead wires in special vacuum tubes.

platinoid A high-resistance alloy similar to German silver but containing also tungsten. It has a fairly low positive temperature coefficient and is used for rheostats.

platinrhodium An alloy of platinum and rhodium, commonly used in thermocouples.

platinum A heavy, almost white metal that resists the action of practically all acids, is capable of withstanding high temperatures, and is little affected by sparks. Used for contact points in switches and relays.

platinum contacts Contacts used in devices where currents must be broken frequently, as in induction coils and electric bells. Platinum is less damaged by sparking than other metals, and hence ensures a clean contact with minimum attention.

platter Term generally used for describing a 16 inch diameter electrical transcription recorded at $33\frac{1}{3}$ revolutions per minute and used in broadcast studios for transcribed programs.

playback Playing a recording immediately after it is made.

playback reproducer A phonograph pickup.

plethysmograph An instrument for testing blood flow. One type uses a phototube to measure color changes in the blood, sometimes after a dye is injected into the blood stream. Also called *electroarteriograph*.

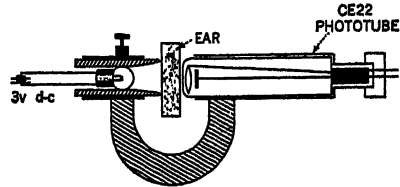

Photoelectric plethysmograph designed to clip over the ear lobe of a pilot for monitoring the oxygen content of his blood.

pliodynatron A thermionic vacuum tube having an additional grid maintained at a higher voltage than the plate. The tube is placed in a magnetic field to limit secondary emission when used as an oscillator.

pliotron A high-vacuum thermionic tube in which one or more electrodes (grids) are employed to control the unidirectional electron flow from cathode to anode (the plate current). All amplifier tubes in radio sets are pliotrons, but the term has never gained extensive use.

plug 1. A device that, by insertion in a wall outlet or receptacle, establishes connection between the conductors attached to the plug and the conductors permanently connected to the receptacle. A

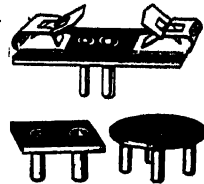

Battery plugs.

plug thus serves to make a temporary connection to the terminals of the receptacle, outlet, jack, or socket into which the plug is inserted. The plug most generally used in telephone and other audio-frequency work has three separate contacting parts: the tip, the ring and the sleeve. 2. Advertising material inserted in a radio program.

plugging A system of electric braking in which the motor connections are reversed for stopping, with a series

resistance being used to keep the current at a safe value and with means for opening the circuit when the motor stops, so that it does not actually reverse.

plug-in Having terminals such that connections are made automatically by plugging the device into a socket or series of jacks.

plug-in coil A coil wound on a form often resembling an elongated tube base, with the coil leads connected to the pins on the base. These coils can be interchanged as easily as radio tubes, and are used for changing the tuning range of a receiver or transmitter.

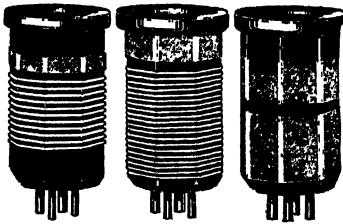

Plug-in coils.

plug-in device A coil, transformer, crystal unit, or other device having terminals so arranged that all connections can be made simultaneously by pushing the device into a suitable socket.

plug-in resistor A fixed resistor having terminals arranged for plugging into a socket or jacks. The most common types, used for filament voltage-dropping purposes in receivers, are mounted in metal or glass envelopes and resemble radio tubes. These should not be called ballast tubes unless they definitely have a ballast action that tends to maintain constant voltage.

plunger-type instrument A moving-iron instrument in which the pointer is attached to a long and specially shaped piece of iron that is drawn into a coil carrying the current to be measured.

p-m 1. Abbreviation for phase modulation. Same abbreviation used for noun and adjective. 2. Abbreviation for permanent magnet.

pneumatic loudspeaker A loudspeaker in which the acoustic output results from controlled variation of an air stream.

point effect The fact that a discharge will occur more readily at sharp points than elsewhere on an object or electrode.

pointer The needle-shaped rod that moves over the scale of a meter.

point of communication A specific location to which a radio station is authorized to communicate for the transmission of public correspondence.

point source A light source whose dimensions are small compared with the distance from which it is viewed.

point-to-point communication Radio communication between two definite fixed stations.

point-to-point telegraph station A fixed station authorized for radiotelegraph communication.

point-to-point telephone station A fixed station authorized for radiotelephone communication.

poison A substance that reduces phosphorescence in a luminescent material. Thus, iron is a poison to certain phosphorescent materials prepared from zinc sulphide, and extreme care must be taken to keep iron out of those compounds. The opposite of poison is phosphorogen, which promotes phosphorescence.

Poisson's equation At any point in an isotropic medium, the divergence of the electric displacement is proportional to the density of the electric charge.

polar Pertaining to, measured from, or having a pole, such as the poles of the earth or of a magnet.

polar coordinates A system of coordinates in which a point is located by its distance from a fixed point and the angle that the line from this fixed point to the given point makes with a fixed reference line called the polar axis.

POLAR DIAGRAM

polar diagram A diagram employing polar coordinates to show the magnitude of a quantity in some or all directions from a point.

polarimeter A polariscope having provisions for measuring the state of polarization.

polariscope An instrument for examining the state of polarization of light or other radiation and for studying polarizing properties of various materials and devices.

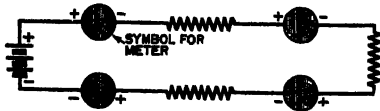

CORRECT CONNECTIONS FOR CURRENT MEASUREMENTS

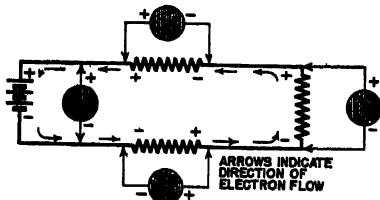

CORRECT CONNECTIONS FOR VOLTAGE MEASUREMENTS

Correct polarities for ammeter and voltmeter connections.

polarity 1. An electrical condition determining the direction in which current tends to flow. Usually applied to batteries and other direct-voltage sources. 2. The quality of having two opposite charges, one positive and the other negative. 3. The quality of having two opposite magnetic poles, one north and the other south.

polarity indicator An instrument used to identify the positive and negative terminals in a direct-current circuit.

polarity wiring A method of wiring buildings, in which a white wire is always used for the ground side of each branch circuit.

polarization 1. In optics, the act or process of making light or other radiation vibrate in a definite form so that

the paths of the vibrations in a plane perpendicular to the ray are straight lines, circles, or ellipses, giving, respectively, plane polarization, circular polarization, or elliptical polarization. 2. In electrolysis, an increase in the resistance of an electrolytic cell due to a change in the potential of an electrode during electrolysis. In dry cells it shortens the useful life. 3. The effect produced in a dielectric when it is placed in an electric field, whereby the positive charge in each atom is slightly displaced with reference to the negative charge. 4. In magnetism, the orientation of molecule-size magnets in a piece of iron or other magnetic material that is placed in a magnetic field, whereby the tiny internal magnets tend to line up with the magnetic lines of force. 5. In radio, a term used in specifying the direction of the electric vector in a linearly polarized radio wave as radiated from a transmitting antenna.

polarization cycle The pattern formed by the end of the rotating vector representing the vibrations in a beam of polarized radiation. It is a straight line for plane-polarized light, an ellipse for elliptically polarized light, and a circle for circularly polarized light.

polarization diversity A variation in the polarization of a received radio wave from horizontal to vertical and to skew angles during fading. This effect can be utilized to counteract fading by using one horizontal doublet and one vertical antenna at the same spot, each feeding its own receiver, and combining the receiver outputs in such a way that the strongest signal is utilized at each instant just as in space-diversity reception.

polarization errors Errors in the bearing or course indicated by a radio beacon or direction finder, introduced by horizontally polarized components of the electric field under certain transmission conditions. Originally called night effects because they are generally greatest at night.

polarization photometer A photometer that measures the intensity of the light

from a source by using polarizing devices.

polarization plane A plane associated with a ray of plane-polarized radiation. It is believed to correspond to the vibrations of the magnetic vector as the wave progresses.

polarize 1. To produce poles, as by magnetizing a piece of iron. 2. To make light or other radiation vibrate in a definite form. 3. To produce any other type of polarization.

polarized ammeter An ammeter for direct-current circuits, having a pointer that is deflected in opposite directions by currents flowing in opposite directions.

polarized light Light that vibrates in only one plane. Ordinary light sends out vibrations in all directions, like the spokes of a wagon wheel. Polarized light would correspond to the condition in which only two opposite spokes remain, such as the two vertical spokes.

polarized relay A relay in which the movement of the armature depends on the direction of the current in the circuit controlling the armature.

polarizer A Nicol prism or other device for polarizing light. More specifically, it is the first of two prisms used for the purpose, and receives the light as it enters; the other is called the analyzer.

polarizing angle The angle (to the perpendicular) at which light must fall on a dielectric reflecting surface in order to get maximum plane polarization in the reflected light.

polarizing current The direct current flowing through an iron-core choke coil. It brings the core toward magnetic saturation and thus determines the inductance value.

polarograph An instrument for automatically recording the current-voltage curve of a solution during polarographic analysis.

polarographic analysis Analysis of chemical solutions by interpretation of the current-voltage curve obtained by

placing the solution in a container or cell having a mercury anode at the bottom and having a dropping-mercury cathode. Current measurements are made while a direct voltage is applied to the electrodes and gradually increased. The resulting values can be plotted, or a special instrument called a polarograph can be used to record the current-voltage curve automatically. In a recent development, interpretation is based on a pattern produced on the screen of a cathode-ray oscilloscope.

Polaroid A light-polarizing material made by depositing on a sheet of glass or transparent celluloid a chemical solution that crystallizes and then has light-polarizing properties.

polar radiation pattern 1. A diagram showing the relative strength of the radiation from an antenna in all directions in a given plane. 2. A diagram showing the strength of sound waves radiated from a loudspeaker in various directions in a given plane, or a similar response pattern for a microphone.

pole 1. One end of a magnet. 2. One electrode of a battery.

pole piece A piece of ferromagnetic material forming one end of an electromagnet or permanent magnet, and so shaped as to control the distribution of the magnetic flux in the vicinity.

pole shoe That portion of a field pole which faces the armature of a rotating machine. It may be separable from the body of the pole.



Police radio systems result in greater mobility and better organization.

POLICE CALLS

police calls Broadcasts or orders issued by police radio stations. They can be heard on some broadcast band receivers at the high-frequency end of the dial.

polycylindrical endovibrator A cylinder with two end plates inside which are mounted a number of coaxial cylinders fixed alternately to one or the other end plate, with the free ends of the cylinders not quite reaching the opposite plate. The arrangement is equivalent to a number of coaxial lines connected in series, each formed by the outer surface of one cylinder and the inner surface of the next larger cylinder. Also called *multiple resonant line*.

polymer One of two or more substances having the same kinds of atoms in the same proportions but different molecular weights, such as acetylene (C_2H_2) and benzene (C_6H_6).

polyphase Having or utilizing several phases. Thus, a polyphase motor operates from a power line having several different phases of alternating current.

polyphase motor A motor designed for operation from a polyphase circuit.

polyphase synchronous generator A generator that produces at its terminals two or more symmetrical alternating voltages having definite phase relationships to each other (90 electrical degrees for two-phase machines and 120 electrical degrees for three-phase machines).

polyphase transformer A transformer designed for use in polyphase circuits.

polystyrene A thermoplastic material having excellent dielectric properties, crystal clarity, and good chemical resistance. Used for coil insulation, insulation between plates in capacitors, insulating beads in coaxial cables, optical lenses, insulators, sockets for ultrahigh-frequency work, etc.

pool tank A pool tube having a heavy metal envelope somewhat resembling a tank.

pool tube A gas-discharge tube with a pool-type cathode (liquid or solid) in which no means is provided for controlling the unidirectional current flow. Used for rectification. Also called *pool tank* or simply *tank*.

porcelain A ceramic material made by baking a mixture of various materials such as silicates, quartz, and kaolin. Used for insulators.

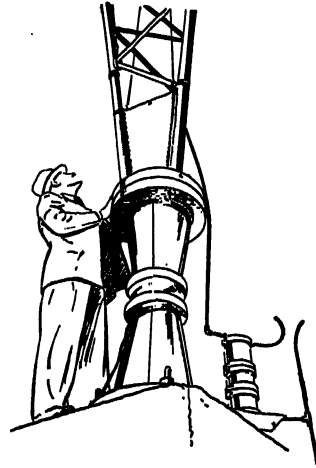

Porcelain insulators supporting 60-ton KDKA tower.

portable receiver A relatively compact and lightweight radio receiver that is completely self-contained.

portable recorder A sound recorder built into a carrying case and designed for portable operation.

portable transmitter A complete radio transmitter designed so that it can be readily transported from place to place.

position report A radio message, in a specified form, containing relevant items of information on the position and progress of a vessel or an aircraft.

position-type telemeter A telemeter that employs the relative phase position between two or more electric quantities, or the magnitude relation of two or more quantities, as the translating means.

positive 1. Having fewer electrons than normal, and hence having the ability

POSITIVE PICTURE PHASE

to attract electrons. 2. Having a definite action that is not likely to fail. 3. Numerically greater than zero; not negative and not reversed in sense. 4. Having the same rendition of light and shade as in the original subject, as a positive image.

positive bias The condition in which the control grid of a vacuum tube is positive with respect to the cathode.

positive charge The condition existing in a body having fewer electrons than normal.

positive column A luminous region, often consisting of alternate light and dark bands between the Faraday dark space and the anode in a Crookes tube or other glow discharge tube at moderate pressures.

positive electricity That kind of electricity which predominates in a body composed of glass after it has been electrified by rubbing with silk.

positive electrode The body of conducting material that serves as the anode in a primary cell when the cell is discharging. It is connected to the positive terminal of the cell. Electrons flow through the external circuit to the positive electrode.

positive electron Another name for the positron, which is like the electron except for having a unit positive charge.

positive feedback Feedback that results in increasing the amplification or is of such phase relationship as to sustain oscillations. Also called *regeneration*.

positive grid Any grid whose potential is positive with respect to the cathode in a vacuum tube.

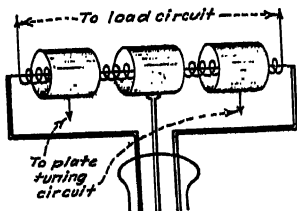

Electrode arrangement of a positive-grid or retarding-field oscillator tube having a spiral grid and a divided plate.

positive-grid oscillator An oscillator capable of generating frequencies up to about 5,000 megacycles. It employs a triode tube in which electrons oscillate or vibrate back and forth through the meshes of a grid that is maintained positive with respect to the cathode. The frequency depends on the transit time of the electrons, and this in turn depends on the electrode dimensions and the voltages at which they are operated. Because electrons are negatively charged, the positive grid produces a retarding field that pulls electrons back after they have passed through the grid on their way to the plate, initiating the electron vibration. Barkhausen-Kurz and Gill-Morrell oscillators are examples. Also called *retarding-field oscillator*.

positive-ion emission Thermionic emission of positive particles that are ions of the metal used as the cathode of a vacuum tube or are due to some impurity in the cathode.

positive ion sheath A collection of positive ions on the control grid of a gas-filled triode tube. If a sufficiently high negative bias is applied to the grid, this positive sheath blocks plate-current flow.

positive modulation 1. In an amplitude-modulation television or facsimile system, that form of modulation in which maximum transmitted power corresponds to maximum light intensity at the television camera or minimum density of the subject copy in facsimile. 2. In a frequency-modulation facsimile system, it is that form of modulation in which the highest transmitter frequency corresponds to the minimum density of the subject copy.

positive modulation factor The ratio of the maximum positive departure of the envelope of an amplitude-modulation wave from its average value to its average value. This rating is used when the modulating signal wave has unequal positive and negative peaks.

positive picture phase A condition in which increases in brilliancy of the

POSITIVE PLATE

scene or picture being televised make the picture signal voltage increase in a positive direction above the zero level.

positive plate The grid of lead that is filled with active material and is connected to the positive terminal of a storage battery. Electrons flow toward it through the external circuit when the battery is discharging.

positive-ray analysis The separation of atoms and measurement of their masses by subjecting positive ions to the deflecting effects of electric or magnetic fields.

positive-ray current A current in a rarefied gas, comprising the movement of positively charged particles. Also called *anode-ray current*.

positive rays Streams of positively charged atoms or molecules (positive ions) that travel in the direction from the anode to the cathode in certain types of evacuated tubes. These rays are commonly observed in the space behind the cathode after passing through openings or canals in the cathode. Also called *canal rays*.

positive temperature coefficient The characteristic in which the resistance of a substance increases when temperature increases. All metals and most metallic alloys have this characteristic. Carbon has a negative temperature coefficient.

positive terminal That terminal of a battery or other voltage source toward which electrons flow through the external circuit from the negative terminal.

positive transmission The transmission of television signals in such a way that an increase in initial light intensity causes an increase in the transmitted power.

positive tube A thyatron having a control grid that is spaced and proportioned to prevent ionization until the grid is made positive with respect to the cathode. These tubes can be operated at higher frequencies than

thyatrons responding to negative grid potentials.

positron A positive charge believed to have the same mass as that of the electron, and having a unit positive charge that is the counterpart of the unit negative charge of the electron. Also called *positive electron*.

post-office bridge A form of Wheatstone bridge in which desired resistance values are obtained by inserting or removing plugs that fit between special terminals.

potassium An alkali metal having photosensitive characteristics, used on the cathodes of phototubes when maximum response is desired to blue light.

potential The degree of electrification as referred to some standard, such as earth. The potential at a point is the amount of work required to bring a unit quantity of electricity from infinity to that point. Potential and voltage are often used interchangeably.

potential barrier A region in which the electric potential is such that moving electric charges attempting to pass through it encounter opposition and may be turned back. The potential required for this purpose is called the stopping potential.

potential coil In a measuring instrument or other device having series and shunt coils, the shunt coil is the potential coil because it is connected across the circuit and is affected by changes in voltage.

potential difference 1. The algebraic difference between the individual potentials of two points; hence the voltage existing between two points. 2. The amount of work required to bring a unit charge from one point to another. Equivalent phrases more commonly used are *voltage* and *voltage drop*.

potential divider A voltage divider.

potential energy Energy due to the position of a particle or piece of matter with respect to other particles. Thus,

a weight held above the ground has potential energy. An electrostatic field has potential energy.

potential function A function that constitutes the variable factor in the expression for any physical potential, such as for electric potential.

potential galvanometer A galvanometer-type instrument having such high resistance that it takes practically no current. It has been replaced by the modern electronic vacuum-tube voltmeter.

potential gradient The difference in the values of the potential per unit length along a conductor or through a dielectric.

potential hole A region toward which the electric potential drops abruptly. The term is common in nuclear physics.

potential transformer An instrument transformer intended for measurement or control purposes, and designed to have its primary winding connected in parallel with the circuit whose voltage is to be measured or controlled. Also called *voltage transformer*.

potential winding Any winding connected across the two sides of a circuit, and hence acted on by the circuit voltage.

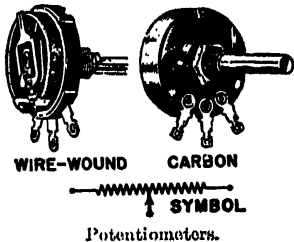

Potentiometers.

potentiometer 1. Popular name for a variable resistance unit having a rotating contact arm that can be set at any desired point along a curved resistance element. The voltage source is connected to the end terminals of the resistance element, and the output circuit is connected between one end terminal and the movable contact to give a voltage-dividing action.

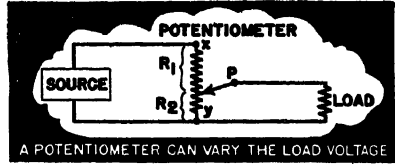

A POTENTIOMETER CAN VARY THE LOAD VOLTAGE



FROM MAXIMUM VALUE



ALL THE WAY TO ZERO

Action of a potentiometer.

2. A true potentiometer is an instrument for measuring potential difference by balancing it against the voltage drop between two points on a calibrated adjustable resistance carrying a constant current.

potentiometer control Control by means of a variable voltage obtained with a sliding contact on a resistance connected across part or all of a voltage source.

pothead An insulator used in making a sealed joint between an underground cable and an overhead line.

Potier diagram A vector diagram showing the voltage and current relations in an alternating-current generator.

Potter-Bucky grid A grid of lead strips placed in front of the specimen or patient being examined with an X-ray machine, to absorb scattered X-ray radiation and prevent it from fogging the film.

Poulsen arc A direct-current arc between electrodes in a chamber through which hydrogen or illuminating gas is passed continuously. In parallel with the arc outside the chamber is an oscillating circuit containing a capacitor and the primary circuit of an air-core transformer. The combination produces undamped radio-frequency oscillations, and was used extensively for producing radio signals before the days of vacuum-tube transmitters.

poundal The absolute English unit of force. It will give a free mass of one

POWDERED IRON CORE

pound an acceleration of one foot per second per second.

powdered iron core A core consisting of finely divided particles of magnetic material mixed with a suitable bonding material and pressed into shape. Used with radio-frequency coils at frequencies up to several hundred megacycles, permitting a reduction in turns for a given inductance without excessive losses due to eddy currents. Also called *Ferrocort core*.

powder metallurgy The art of producing metal objects, transformer cores, Alnico magnets, tungsten for filaments, oilless bearings, etc., by compressing finely powdered metals in molding dies, then treating at a temperature below the fusion point of the metal.

power 1. The time rate of doing work. 2. The rate at which electric energy is being fed to or taken from a device, measured in watts. 3. The result obtained when a number or quantity is multiplied by itself a particular number of times. Thus, 125 is the third power of 5.

power amplification The ratio of the signal power delivered by the output circuit of an amplifier to the signal power supplied to the input circuit.

power amplifier 1. An audio-frequency amplifier having one or more power tubes and designed to deliver relatively large amounts of audio-frequency power. 2. A radio-frequency amplifier located somewhere between the oscillator and antenna in a transmitter and having as its chief function the increasing of radio-frequency power.

power-amplifier stage 1. An audio-frequency amplifier stage that is capable of handling considerable audio-frequency power without distortion. 2. A radio-frequency amplifier stage that serves primarily to increase the power of the carrier signal in a transmitter.

power cord The two-wire flexible cord used to connect a radio receiver or portable electric appliance to a convenience outlet.

power detector A detector circuit that will handle strong input signals without objectionable distortion.

power factor The ratio of active power to apparent power. As a percentage rating, it is equal to the resistance of a part or circuit divided by the impedance at the operating frequency, with the result multiplied by 100. A pure resistor has a power factor of 100 per cent. A pure capacitor has a power factor of 0 per cent leading, while a pure inductor (coil) has a power factor of 0 per cent lagging. Power factor is equal to the cosine of the phase angle between the current and voltage when both are sinusoidal.

power-factor correction Addition of capacitors to an inductive circuit to increase the power factor. The capacitors offset part or all of the inductive reactance, making the total circuit current more nearly in phase with the applied voltage.

power-factor meter An instrument for measuring power factor. Its scale is usually graduated in percentage power factor.

power gain The ratio of the powers required to produce a field strength with a standard comparison antenna to the power required to produce the same field strength with the antenna in question. The power gain is usually expressed in decibels.

power level The amount of power being transmitted past any point in a system. It can be expressed in watts, decibels, or volume units.

power-level indicator An alternating-current voltmeter calibrated to read audio-frequency power level in decibels or volume units.



Capacitor-type power-line filter, used to prevent power-line noise from entering a radio receiver.

power line Two or more wires conducting electric power from one location to another.

power output tube A power tube.

power pack The power supply unit of a radio receiver or other electronic unit. It converts the available power line or battery voltage to the values required by the apparatus.

power rating For a radio transmitter, the power available at the output terminals of the transmitter when these are connected to the normal load circuit or to an equivalent circuit. For an amplitude-modulation telephone transmitter, it is the power available when the carrier is being modulated to its specified modulation capability. For a continuous-wave telegraph transmitter, it is the power delivered with the key closed.

power ratio The ratio of the power output to the power input of a device. The result is usually expressed as the number of decibels loss or gain.

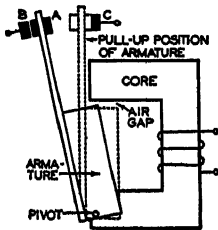

Power relay circuit (minimum-reluctance type).

power relay 1. A relay that functions at a predetermined value of power.
2. The final relay in a sequence of relays controlling a load or a magnetic contactor.

power switch The main switch in a radio receiver, transmitter, or other equipment. It connects or disconnects the unit from its power line. Often called on-off switch.

power transformer An iron-core transformer having a primary winding that is connected to an alternating-current power line and having a number of secondary windings that

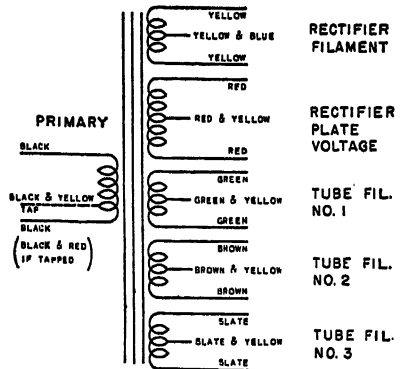

Power-transformer lead color code.

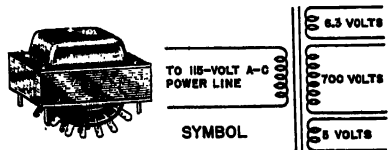

Power transformer.

provide the required different alternating voltage values in a radio receiver, transmitter, or other equipment.

power tube A tube capable of handling more current and power than an ordinary voltage-amplifier tube. It is used in the last stage of an audio-frequency amplifier or in high-power stages of a radio transmitter.

Poynting's theorem If there is a flow of electromagnetic energy into or out of a closed region, the rate of flow of this energy is at any instant proportional to the surface integral of the vector product of the electric and magnetic intensities. This vector product is called Poynting's vector, and has important applications for electric waves.

Poynting's vector The vector product of the electric and magnetic intensities involved in Poynting's theorem.

practical system A system of electrical units in which the units are multiples or submultiples of centimeter-gram-second electromagnetic units. The units in the practical system were so selected that, at the time of its estab-

PREAMBLE

ishment, the more important units would be of convenient size and the proportionality factor would be unity in the most common electrical equations. Practical units are the ampere, coulomb, volt, ohm, henry, farad, joule, watt, and watt-hour.

preamble The portion of a commercial radio-telegraph message that is sent first. It contains the prefix, message number, office of origin, word check, time filed, date, and other data not part of the original message.

preamplifier An audio-frequency amplifier used ahead of the main audio-frequency amplifier in a radio studio or at the input of a transmission line.

precedence indicator A device that indicates which of two or more actions comes first. The electronic version, employing thyratrons, has a high degree of accuracy.

precipitation Separation of dust particles from air by means of an electrostatic precipitator.

precipitation static Static interference due to rain, sleet, snow, or electrically charged clouds, often severely affecting aircraft radio communication.

precipitator An apparatus for removing small particles from air by electrostatic precipitation, as in the Precipitron.

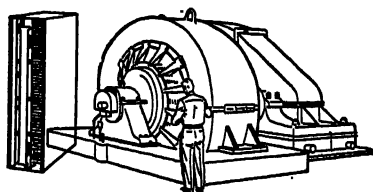

Precipitron unit being used to protect rotating machinery from dust.

Precipitron An electronic apparatus for removing smoke, dust, oil mist, or other small particles from air. A high direct voltage, of the order of 10,000 volts, is obtained from high-voltage rectifier tubes and applied to a fine wire mesh through which the air is drawn by a fan. Particles in the air are charged by this screen, and are then drawn through a system of

parallel charged plates that attract the particles and remove them from the air.

precision Adapted for extremely accurate scientific measurement. It is not, however, a guarantee of accuracy (negligible error), because precision refers to the measuring instrument and does not cover external sources of error inherent in the measuring method.

preconduction current The low value of plate current flowing in a thyatron or other grid-controlled gas tube prior to the start of conduction.

Preece's formula The fusing current of a conductor made of given material is proportional to the 1.5 power of the diameter.

preemphasis 1. Increasing the relative strength of higher audio frequencies in a methodical manner at a frequency-modulation transmitter prior to transmission to ensure that these components will override noise. Original relations are restored at the receiver by deemphasis. 2. Increasing the relative level of some audio frequencies with respect to others during sound recording.

prefix A number or letter designation used in the preamble of a radio-telegraph message to indicate the general nature of the message.

preselector The section ahead of the frequency converter (oscillator-mixer first detector) in a superheterodyne receiver. It may be simply a tuned circuit connecting the antenna to the input of the first detector, or may have one or more tuned or untuned radio-frequency amplifier stages.

preselector stage A radio-frequency amplifier stage in the preselector of a superheterodyne receiver.

preservative A solution intended to increase the life of instantaneous recording disks.

press In a vacuum tube, the glass that is pressed around the electrode support wires and electrode leads to hold them

in correct relations to each other and to bring the leads through the glass envelope of the tube.

pressing 1. A commercial phonograph record. 2. The process by which commercial phonograph records are made from stampers.

pressure amplitude The maximum absolute value of the instantaneous sound pressure at a point during any given cycle, for a sinusoidal sound wave. The unit is the dyne per square centimeter. The term maximum sound pressure applies to all types of sound waves.

pressure level The pressure level in decibels of a sound is twenty times the logarithm to the base 10 of the ratio of the effective pressure P of this sound to the reference pressure P_0 . Unless otherwise specified, the reference pressure is understood to be 0.0002 dyne per square centimeter.

pressure microphone A microphone in which the electrical response is caused by variation in pressure in the actuating sound wave. Examples are carbon, condenser, moving-coil (dynamic), and crystal microphones.

pressure-type capacitor A fixed or variable capacitor mounted in a metal tank filled with nitrogen at a pressure that may be as great as 300 pounds per square inch. The high pressure permits a voltage rating several times that of the air rating. Used chiefly in transmitters.

pressure welding A group of welding processes in which mechanical pressure is applied during welding to hold the parts together. Examples are resistance welding, spot welding, seam welding, and percussive welding.

primary 1. That transformer winding which receives energy from a supply circuit. The secondary receives the energy by electromagnetic induction from the primary. 2. First in order of importance, placement, or development.

primary battery A battery consisting of one or more primary cells.

primary cell A cell designed to produce electric current through an electrochemical reaction that is not efficiently reversible. When discharged, the cell cannot be efficiently recharged by an electric current.

primary circuit The first, in electrical order, of two or more coupled circuits, such as the primary winding of a transformer.

primary colors Additive primary colors are three colors which, when added in proper proportions, produce a sensation of white; one combination is red, green, and blue. With subtractive primary colors (as red, blue, and yellow), white light is completely absorbed when passed in succession through transparent screens of these colors.

primary current The current flowing through the primary winding of a transformer. Changes in this current cause a voltage to be induced in the secondary winding.

primary dark space A narrow non-luminous region appearing between the cathode and the cathode glow for certain gases used in gas discharge tubes.

primary electron That electron which has the greater energy after a collision between two electrons. The other is the secondary electron.

primary emission Electron streams or cathode rays which, when bombarding a material, excite secondary emission from the material. Usually called primary radiation when the exciting radiation consists of ultraviolet rays or X rays.

primary relay The relay that produces the initial action in a sequence of operations.

primary service area The area in which the ground wave of a broadcast station is not subject to objectionable interference or fading.

primary skip zone The area around a radio transmitter that is within the skip distance but beyond the ground-

PRIMARY STANDARD

wave range. Radio reception is possible in the primary skip zone only by sporadic, scattered, and zigzag reflections.

primary standard A unit directly defined and established by some authority, against which all secondary standards are calibrated.

primary voltage The voltage applied to the terminals of the primary winding of a transformer.

primary winding The input winding to which voltage is applied in a transformer.

prime mover Any engine, turbine, or other source of mechanical power used to drive an electric generator.

priming illumination A small steady illumination applied to a phototube or photoelectric cell to make it more sensitive to the variations in illumination being measured.

principal axis A line so chosen with reference to a rigid body that the body may rotate about that line without developing a centrifugal torque in any plane containing the line.

principal focus The focus for a beam of rays parallel to the axis of a lens or mirror.

printer telegraph code A five- or seven-unit code used for operation of teleprinter, teletypewriter, and similar telegraph printing services. The seven-unit code requires only three marking elements out of the seven available per character. If fewer than three are received because of fading, or if more than three impulses arrive

	1	2	3	4	5	6	7
A							
B							
C							
D							
E							
F							
G							
H							
I							
J							
K							
L							
M							
N							
O							
P							
Q							
R							
S							
T							
U							
V							
W							
X							
Y							
Z							
&							
-							
SHIFT							
UNSH							
BELL							
SPACE							
LINE							
-							
Z							

Seven-unit printer telegraph code used in printing-telegraph service.

because of static, the receiving machine prints a special error-indicator sign rather than an improper letter.

printing telegraphy That method of telegraph operation in which the received signals are automatically recorded in printed characters.

prism A piece of optical glass or other transparent material having a triangular cross-section, used to reflect or refract light rays.



Action of a prism.

probability amplitude A wave function, commonly denoted by ψ , which satisfies the Schrodinger wave equation and other similar equations of wave mechanics and corresponds to a quantum condition actually fulfilled in nature.

probable error That amount of error which, according to the laws of probability, is most likely to occur during a measurement. Half the results will have a greater error than this value, and the other half of the series of results will have less error than the probable error.

profilometer An instrument for measuring surface roughness.

program amplifier An audio-frequency amplifier in a broadcast transmitter.

program circuit A telephone circuit that has been equalized to handle a wider range of frequencies than are required for ordinary speech signals, so that it can be used for transmission of musical programs over radio networks for broadcasting purposes.

program failure alarm A program-operated vacuum-tube relay that gives a visual and aural alarm when the program fails on the line being monitored. A time delay is provided to prevent the relay from operating and giving a false alarm during station-identification periods or other short periods of silence in program continuity.

progressive scanning In television, a scanning process in which successively

PROPAGATION CONSTANT

traced horizontal lines are adjacent, so that all picture elements are scanned during one vertical sweep of the scanning beam.

projection cathode-ray tube A cathode-ray tube designed to produce an intensely bright but relatively small image that can be projected onto a large viewing screen by an optical system consisting of lenses or a combination of lenses and mirrors.

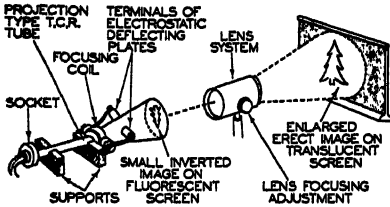

Projection cathode-ray tube used with lens.

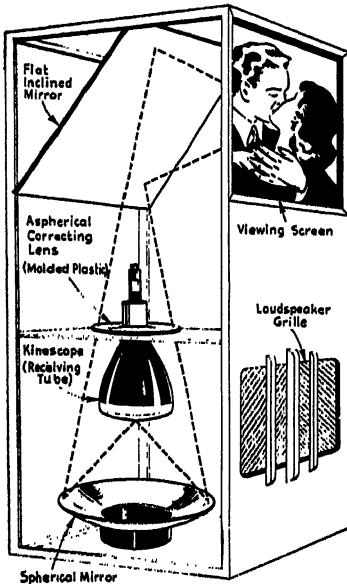

Use of a spherical mirror in a projection-type television receiver.

projector 1. The device used in an underwater sound system to radiate a sound pulse in a desired direction through the water from the bottom of a ship. 2. A horn designed to project sound chiefly in one direction from a loudspeaker.

prone-pressure method A method of reviving a person who has received a severe electric shock. It involves placing the victim in a prone position, face downward, applying gradual pressure just below the ribs to expel air from the lungs, suddenly releasing this pressure, and repeating the process regularly at a rate slightly slower than that of normal breathing.

Prony brake An arrangement for measuring the mechanical output of a motor by the pull on friction blocks bearing against a flywheel mounted on the shaft of the motor.

proof plane A small piece of conducting material mounted on an insulating handle, used to sample the charge of a body and bring this charge to an electroscope to determine its polarity.

propagation The travel of electromagnetic waves or sound waves through a medium, or the travel of a sudden electrical disturbance or sharp change in value along a line or cable. Propagation does not refer to the flow of current in the ordinary sense.

propagation constant 1. For an electric transducer (energy-transferring device), the natural logarithm of the ratio of the current entering the transducer to the current leaving when the transducer is terminated in its iterative impedances. 2. The propagation constant per unit length of a uniform line is the natural logarithm of the ratio of the current at one point on the line to the current at a second point, at unit distance from the first point in the direction of transmission along the line, when the line is infinite in length or is terminated in its characteristic impedance. 3. The propagation constant per section of a periodic line is the natural logarithm of the ratio of the current entering a section to the current leaving the same section, when the periodic line is infinite in length or is terminated in its iterative impedances. The real part of the propagation constant is the attenuation constant, and the imaginary part is the phase constant (wavelength constant). 4. For transmission of

PROPAGATION FACTOR

sound through any enclosure, the natural logarithm of the ratio of the volume velocity of the sound wave at the entrance of the enclosure to that at the exit.

propagation factor The propagation ratio.

propagation ratio The ratio, with respect to two points in a wave, of the displacement at the second point to that at the first point. It is expressed as a vector involving both amplitude and phase angle. The magnitude of this vector is called the attenuation ratio. Also called *propagation factor*, *transfer factor*, or *transfer ratio*.

protective device A device for keeping undesirably large magnitudes of current, voltage, or power out of a given part of an electric circuit.

protective gap A spark gap provided between a conductor and the earth by suitable electrodes to permit high-voltage surges due to lightning to pass harmlessly to earth through the gap without damaging equipment. Usually called *lightning arrester*.

protective resistance A resistance used in series with a gas tube or other device to limit current flow to a safe value.

proton An elementary particle having a positive charge equal to that of the electron. One proton balances one electron. The nucleus of the ordinary hydrogen atom consists of a single proton.

proximity effect Nonuniform current distribution throughout the cross-section of a conductor due to variations of current in a neighboring conductor. In a coil wound with the turns close together, this effect causes high distributed capacitance and an increase in radio-frequency resistance.

psuedodielectric A substance that in its liquid state contains a large number of free ions. These ions still exist in the solid state but cannot move, and hence the solid state has poor conductivity.

PST Abbreviation for Pacific Standard Time.

psychogalvanic phenomenon Changes in electrical characteristics of parts of the body during mental excitement.

psychogalvanometer An instrument for testing mental reaction by determining how skin resistance changes with the application of an external voltage to electrodes in contact with the skin. It requires a high-gain stabilized direct-current amplifier. Also called *pathometer*.

psychointegroammeter An instrument that indicates or records one or more functional variables of a body, such as blood pressure, heart action, or skin resistance, during questioning, to determine when the person is not telling the truth. Popularly called *lie detector*.

psychosomatograph An instrument for recording muscular action currents or physical movements during tests of mental-physical coordination.

public-address amplifier An audio-frequency amplifier used to provide the audio-frequency power required by loudspeakers for adequate sound coverage at a public gathering.

public-address system A complete system for amplifying sounds and providing adequate volume for large public gatherings. It may include one or more microphones or other pickup devices, a powerful audio-frequency amplifier, and a number of loudspeakers.

public aviation service A radiocommunication service open to public correspondence (paid or toll messages) to provide public communications to, from, and between aircraft in flight.

pulling The effect occurring when the frequency of an oscillator is forced, by some form of coupling, to change toward the frequency of another oscillation.

pull-out torque The value of overload torque at which an induction motor falls out of synchronism with the power-line frequency and hence stops.

pull-up current The minimum current value that will cause the armature of a

PUSH-PULL CIRCUIT

relay to be pulled against the relay core.

pulsating current A periodic current that is the sum of a direct current and an alternating current. This term is usually applied to the condition in which the value of the direct current is greater than the maximum amplitude of the alternating current, so that electron flow is always in the same direction.

pulsating direct current A direct current that is changing in value at regular or irregular intervals but has the same direction at all times.

pulsating quantity A periodic quantity that can be considered as the sum of a continuous (fixed) component and an alternating component.

pulse A single disturbance that is propagated as a wave or electric current but has no cyclic characteristics.

pulse-modulated waves Recurrent wave trains in which the duration of the trains is, in general, short compared with the interval between them. Used extensively in radar.

pulse-time modulation A type of radio transmission in which the carrier consists of pulses, with the time interval between pulses being varied in accordance with modulation. The system is intended for ultrahigh-frequency bands, where it takes advantage of inherently wide channels available there and gives improved signal-to-noise ratio. The abbreviation for pulse-time modulation is t-m, analogous to a-m for amplitude modulation, f-m for frequency modulation, and p-m for phase modulation.

puncture A disruptive discharge through insulation, involving a sudden and large increase in current through the insulation due to complete failure under electrostatic stress. Also called *breakdown*.

Pupin coil An iron-core loading coil inserted in telephone lines at regular intervals to balance out the effect of capacitance between the lines.

pup jack A small single-hole jack into which fits a single-pin contact plug. Also called *tip jack*.

pure tone A sound produced by sound waves having only a single frequency, without harmonic frequencies.

pushback hookup wire Tinned copper wire covered with loosely braided insulation that can be pushed back with the fingers sufficiently to expose enough bare wire for making a connection.

pushbutton control Control of motors and other electrical equipment by means of relays and associated starting equipment actuated through auxiliary circuits that are opened and closed by pushbuttons in convenient locations.

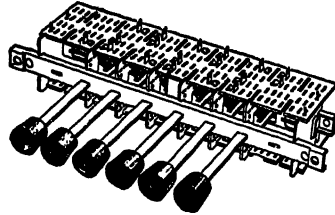

Pushbutton switch.

pushbutton switch A switch in which the contacts are closed by pushing one button and opened by pushing another button.

pushbutton tuner A device that automatically tunes a radio receiver to a desired station when the button assigned to the station is pressed. The button may connect a set of preadjusted trimmer capacitors into receiver tuning circuits, may control a small motor that drives the regular gang-tuning capacitor, or may apply force to a lever or cam system that rotates the gang-tuning capacitor to the correct position.

push-pull circuit An amplifier circuit containing two tubes (or a double-section tube) arranged with the control grids connected to opposite ends of the input transformer secondary winding or to other out-of-phase feed points and with the plates connected to opposite ends of the output trans-

PUSH-PULL MICROPHONE

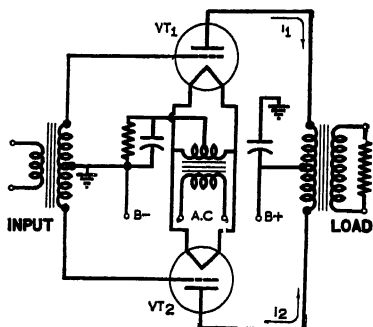

Push-pull amplifier circuit.

former primary winding. Grid voltage is then a maximum on one tube when it is a minimum on the other tube, so that the sum of the plate currents is constant. Signal components add in the output to give twice the output of a single tube, and the arrangement balances out all even harmonics that would otherwise cause distortion.

push-pull microphone A microphone that makes use of two microphone elements operating 180 degrees out of phase.

push-pull oscillator A vacuum-tube oscillator having two tubes connected much as in a push-pull amplifier, with control grids and plates connected to opposite ends of tuned circuits.

push-pull transformer An audio-frequency transformer having a center-tapped winding for use in a push-pull amplifier circuit.

pyranometer An instrument that measures the intensity of the radiation received from any portion of the sky.

pyroelectric The property of developing electrical charges as a result of changes in temperature. It occurs in certain crystals.

pyroheliometer An instrument for measuring the total intensity of solar radiation.

pyrometer An instrument for measuring high temperatures, especially those beyond the range of mercury thermometers. Early pyrometers depended on expansion or contraction of solids with temperature. The more accurate modern pyrometers are based on the change in resistance of a platinum wire, on the production of a thermoelectric current as in a platinum-iridium thermocouple, on the expansion of gases or vapors, on the specific heat of solids, or on the intensity of the heat or light radiated. Radiation pyrometers and optical pyrometers utilize this last principle.

pyron detector A crystal detector in which rectification occurs between iron pyrites and a copper or other metallic point.

Q

Q 1. The quality rating of a coil or a resonant circuit, equal to the inductive reactance divided by the resistance. Also called *Q factor*. 2. Quantity of electricity in coulombs.

Q factor A rating applied to coils and resonant circuits, equal to reactance divided by resistance. Often called simply *Q*.

Q signal A three-letter abbreviation starting with *Q*, used in the International List of Abbreviations for radiotelegraphy to represent complete sentences. The signal is followed by a question mark when the question form of the sentence is intended. Thus, *QRL* means "I am busy," and *QRL?* means "Are you busy?"

QSL card A card sent by one radio amateur to another to verify radio communication with each other.

quad A structural unit employed in cables, consisting of four separately insulated conductors twisted together. The two kinds now in use are the multiple twin quad and the spiral quad.

quadded cable A cable in which at least some of the conductors are arranged in the form of quads.

quadrant A name formerly used for the unit of inductance that is now called the henry.

quadrantal error The error in magnetic compass readings due to the magnetic field of the steel hull of a ship. The error is a maximum when the vessel is pointing NE, SE, SW, or NW and is zero when the ship is pointing N, E, S, or W. A similar error occurs in radio direction finders on vessels and aircraft due to metal structures in the vicinity of the loop antenna.

quadrant electrometer An electrometer for measuring voltages and charges by means of electrostatic forces. It consists of a metal plate suspended

horizontally inside a short vertical cylinder of metal that is divided into four insulated parts, each connected electrically to its opposite. The two pairs of quadrants are connected to the two terminals between which potential difference is to be measured. The resulting electrostatic forces cause an angular displacement of the suspended plate, proportional to voltage.

quadrature Two alternating quantities are in quadrature when the phase angle between them is 90 degrees.

quadrature component The reactive component of a current or voltage due to inductive or capacitive reactance in a circuit.

quadruplex circuit A telegraph circuit designed to carry two messages in each direction at the same time.

qualimeter An instrument for indicating the hardness (penetrating ability) of X rays. Also called *penetrometer*.

qualitative analysis Identification of the ingredients in a substance, without determining how much of each is present.

quality The fidelity of reproduction of a sound program or television image.

quality factor The *Q* factor of a circuit or device, equal to the inductive or capacitive reactance divided by the resistance.

quantitative analysis Determination of the amount of each ingredient that is present in a substance.

quantity of electricity 1. The amount of electrical charge stored in a capacitor, measured in coulombs or similar units, and designed by the symbol *Q*. 2. The amount of electrostatic charge on an object. A plus sign indicates that the object has fewer electrons than normal and hence has a positive charge. A minus sign indicates more

QUANTITY OF X RAYS

electrons than normal and hence a negative charge. 3. The amount of current flowing through a circuit in a given time, measured in coulombs. One coulomb is one ampere flowing for one second.

quantity of X rays The product of intensity of X rays multiplied by time. It is not proportional to energy, but rather is proportional to the total ionization-producing ability.

quantometer A type of ballistic galvanometer in which the deflection of the moving coil is approximately proportional to the quantity of electricity that has passed through the coil.

quantum A definite elemental unit of energy associated with changes among the electrons and with corresponding radiation. The value of a quantum is $h\nu$, where h is Planck's constant (6.547×10^{-27}) and ν is the frequency of the vibration or wave with which the energy is associated. In the case of radiant energy, the quantum is called a light quantum. The plural is quanta.

quantum condition The mathematical condition that must be satisfied for any given quantum state of an atom or other system.

quantum correction The correction required by any classical law or formula to bring it into harmony with the quantum theory.

quantum efficiency The number of photoelectrons emitted from a metal per quantum of incident radiation.

quantum equivalence principle When a quantum of radiation is absorbed in a photoelectric or photovoltaic process, its entire energy reappears in some definite other form, such as the kinetic energy of a released photoelectron or the energy of an ionized atom.

quantum limit The shortest wavelength in an X-ray spectrum produced by an X-ray tube. It is definitely related to the maximum voltage applied to the tube, in accordance with the Planck-Einstein quantum equation. Also called *minimum wavelength*.

quantum mechanics A general physical theory that deals with atomic structure and related problems in terms of quantities that can actually be measured rather than with unconfirmed concepts such as the position of an electron in a supposed orbit. It embraces the matrix mechanics of Heisenberg, the wave mechanics of Schroedinger, and the transformation theory of Jordan and Dirac.

quantum number An integral (whole) number that is characteristic of the statement of a quantum condition. Thus, for a hydrogen atom the energy corresponding to any quantum state is inversely proportional to the square of the principal quantum number.

quantum of action Another name for Planck's constant, equal to 6.547×10^{-27} erg-second.

quantum state One of the states in which an atom or molecule may exist permanently or momentarily. Transitions between these states are thought to cause the emission of distinct radiation frequencies and quanta, corresponding to lines of the spectrum.

quantum theory The theory that atomic radiation can occur only in a certain fixed unit or quantum the size of which is proportional to the frequency of the oscillations. Such quanta of energy are radiated when electrons in an atom pass from one state to another.

quantum transition An abrupt readjustment in an atom or molecule, accompanied by the emission or absorption of a quantum of radiant energy.

quarter-phase Two-phase.

quarter-wave antenna An antenna whose electrical length is equal to one-fourth the wavelength of the signal to be transmitted or received. Its physical length will be slightly shorter than one-quarter wavelength.

quarter-wave attenuator An arrangement of two wire gratings spaced about one-quarter wavelength apart in a wave guide, used to attenuate waves traveling through a guide in one

QUARTZ CRYSTAL

direction. When properly designed, the wave reflected from the first grating is annulled by that reflected from the second, so that all energy reaching the attenuator is either transmitted through the gratings or absorbed by them, with no resultant reflection. If a third grating is added, the attenuator can be made to act on waves traveling in both directions.

quarter-wave filter Two wire gratings spaced about one-quarter wavelength apart in a wave guide and designed to reflect or to absorb almost all the energy of a particular wave. This filter arrangement is useful for eliminating a wave of a parasitic component or for suppressing some other unwanted wave. If more than one wave is to be filtered out, additional pairs of gratings must be added, each spaced a quarter-wavelength of the wave to be suppressed.

quarter-wavelength transformer A one-quarter wavelength section of transmission line, used as an impedance-matching transformer.

quarter-wave plate A plate of mica or other doubly refracting crystal material of such thickness as to introduce a phase difference of one-quarter cycle between the ordinary and the extraordinary components of light passing through.

quarter-wave resonance The condition in which the resonant frequency of a quarter-wave antenna is equal to the operating frequency at which the antenna is to be used.

quarter-wave resonant frequency That frequency at which resonance occurs in a given quarter-wave antenna.

quarter-wave termination A metal plate and a wire grating spaced about one-quarter of a wavelength apart in a wave guide, with the plate serving as the termination of the guide. Waves reflected from the metal plate are annulled by waves reflected from the grating, so that all energy is absorbed (none is reflected) by the quarter-wave termination.

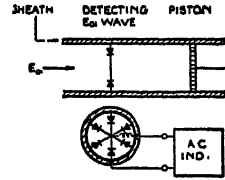

Nonreflecting quarter-wave termination used to feed a signal from a circular wave guide to a sound or television receiver. Cross-section view of detecting grating in guide is shown below.

quarter-wave transmission line A transmission line that is one-quarter wavelength long at the frequency it is handling.

quartz A mineral occurring in hexagonal crystals in nature and having piezoelectric properties that are highly useful in radio. Those crystals from which slabs are cut for radio oscillators are transparent and almost colorless. Quartz transmits ultraviolet light, is resistant to heat, and hence is used in fused form for envelopes of mercury-vapor tubes in sun lamps.

quartz crystal 1. The mother crystal of quartz as found in nature, having a hexagonal cross-section coming to a point at one end and a fractured base where it was broken away from the rock formation in which it grew. 2. A crystal unit in the form of a thin slab or plate cut from a quartz

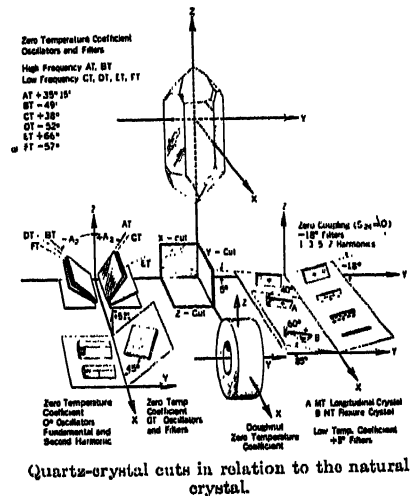

QUARTZ-FIBER MANOMETER

crystal and carefully ground to a thickness that will make it vibrate at the desired natural frequency when supplied with energy. It is used to control the frequency of a vacuum-tube oscillator stage in a transmitter and for other purposes.

quartz-fiber manometer A type of manometer that measures the pressure of a gas by the damping effect of the gas on the vibrations of a quartz fiber.

quartz lamp A mercury-vapor lamp having a transparent envelope made from quartz instead of glass. Quartz resists heat, permitting higher currents, and passes ultraviolet rays that are absorbed by ordinary glass.

quartz oscillator A crystal oscillator in which a carefully ground piece of quartz crystal is connected between the grid and one of the other electrodes of a vacuum tube to produce circuit oscillations at the frequency for which the crystal plate has been ground.

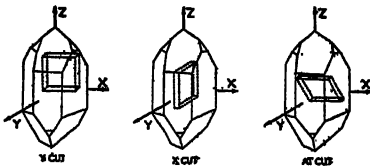

Quartz crystals, showing three ways of cutting thin slabs for radio use.

quartz plate A flat section cut from a quartz crystal in such a way as to provide desired piezoelectric properties. Used in oscillator circuits to control frequency or in filter circuits to control bandwidth passed.

quartz resonator A piezoelectric resonator using a quartz plate.

quench To extinguish, as to stop an arc or spark, to cool a glowing object by immersion in a liquid, or to reduce the fluorescence or phosphorescence of a substance by mixing it with some other substance or by exposing it to the action of an agency such as radiation.

quenched gap A quenched spark gap.

quenched spark A spark consisting only of a few sharply defined oscillations, owing to an arrangement that deion-

izes the gap almost immediately after the initial spark has passed.

quenched spark gap A spark gap having provisions for producing a quenched spark. One form consists of many small gaps between electrodes that have relatively large mass and are good radiators of heat. They serve to cool the gaps rapidly and thereby stop conduction.

quenching frequency A locally generated frequency produced in a superregenerative detector stage at regular intervals to prevent oscillation during reception of strong signals.

quick-break fuse A fuse arranged to draw out the arc and break the circuit rapidly when the fuse wire melts, by separating the broken ends with a spring, weight, or other means.

quick-break switch A switch that breaks a circuit rapidly and independently of the rate at which the switch handle is moved, to minimize arcing.

quiescent carrier telephony A radiotelephony system in which the carrier is suppressed whenever there are no voice signals to be transmitted.

quiescent point The operating point representing one of the direct voltage values for the electrodes of a vacuum tube.

quiescent push-pull A push-pull output stage so arranged in a radio receiver that practically no current flows when no signal is being received. There is thus no noise when tuning between stations.

quiescent value The voltage (or current) value for a vacuum-tube electrode when no signals are present.

quiet automatic volume control Delayed automatic volume control, which does not act until a certain signal strength is reached and which hence does not apply full amplification to background noise when tuning between stations.

quiet tuning Having provisions for silencing the output of a radio receiver at all times except when it is accurately tuned to an incoming carrier wave.

R

R 1. Designation for a resistor on diagrams. 2. Abbreviation for *Reaumur*, a temperature scale.

R Letter symbol used to denote resistance in ohms.

R_p Symbol generally used to denote the plate resistance of a vacuum tube.

Ra Chemical symbol for radium.

rack and pinion A method of securing controlled motion, consisting of a gear (pinion) meshing with a toothed bar (rack). Rotation of the pinion causes the rack to move back and forth. This arrangement is used for focusing purposes in some television cameras.

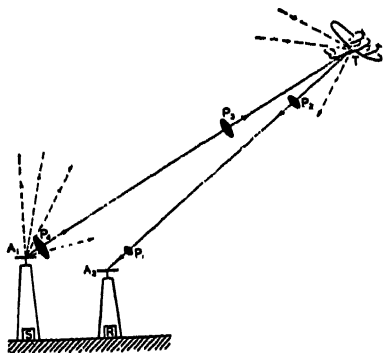

Radar makes use of radio wave pulses P , which are emitted at regular intervals from the sending antenna A_1 . The echo pulses reflected from the target T are picked up by receiving antenna A_2 , and the time of travel is converted electronically into target distance.

radar Radio detecting and ranging apparatus, based on the principle that ultrahigh-frequency radio waves travel at a definite speed and are reflected from objects they encounter. The waves are radiated as beams by a directional antenna array that can be swept through space at all angles, and the reflected wave is picked up by an ultrahigh-frequency receiver. The

elapsed time between transmission and reception of a wave pulse is measured electronically to give the distance or range to the reflecting object, and the elevation and azimuth to the object correspond to the elevation and azimuth of the directional array at the time when the pulse is received. On aircraft, the beam can be directed downward to the earth, and the varying degrees of reflection from buildings, trees, and other surface objects produce on the screen of a cathode-ray tube an accurate profile of the terrain being flown over. Also called *radio locator*.

radar equation The basic equation applicable to a radar system. Its simplest and most fundamental form is the free-space radar equation which governs the radar signal when it is propagated between a radar and a reflecting object or target in otherwise empty space. The equation gives the range of the target in terms of peak transmitter power, the maximum power gain of the radiator, the echo area or scattering cross-section of the target, the effective absorption cross-section of the receiving antenna, and the power generated at the receiver input. The maximum range of a radar depends on the fourth root of the transmitter power, the antenna gain and absorption area, the target echo area, and the inverse of the minimum discernible received power.

radar trace The pattern produced on the fluorescent screen of the cathode-ray tube in a radar unit. The fluorescent spot starts its sweep from left to right at the instant a pulse is transmitted, and each received echo from a reflecting object or target produces a peak or pip on the trace. From known constants, a scale of distances can be made and superimposed on the trace to determine distance to the target.

RADIAL

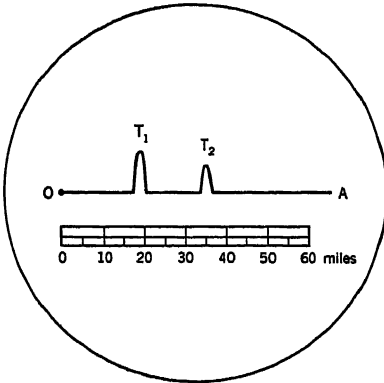

Example of one type of trace seen on radar screens. The fluorescent spot sweeps along the time base OA in synchronism with the transmitted pulses. The received echoes from two different targets are seen at a distance from O corresponding to the time taken for the pulses to travel to and from the targets T_1 and T_2 . The time base can be provided with a range scale as shown. This trace is known as an A scope presentation.

radial Pertaining to or placed like a radius, and hence extending or moving outward from a central point like the spokes of a wagon wheel.

radial-beam tube A vacuum tube producing a flat radial beam of electrons that can be rotated about the axis of the tube by application of an external rotating magnetic field. A large number of separate anodes may be arranged

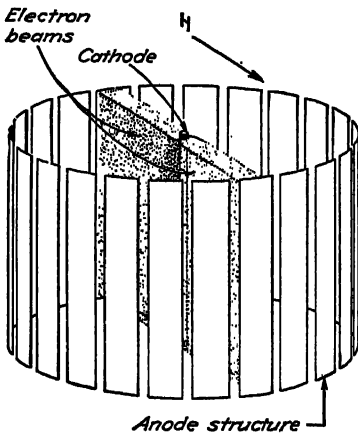

Electrode structure of a 22-anode radial-beam tube. A rotating magnetic field H can focus the double electron beam on any desired pair of opposite anodes.

in a circle around the cathode and grid structure, in which case the tube can serve as an electronic commutator. It has been used successfully as a switch in a 30-channel multiplex telegraph system. In one version, a single rather than double beam is attained by feeding the anodes in such a way that a rotating electric field is produced to act with the rotating external magnetic field.

radial component A component acting along the radius, as contrasted to a tangential component that acts at right angles to a radius.

radial grating A conformal wire grating consisting of wires arranged radially in a circular frame, like the spokes of a wagon wheel. The radial grating is placed inside a circular wave guide to obstruct E waves of zero order while passing the corresponding H waves.

radial lead A lead coming from the side of a component rather than axially from the end. Resistors often have radial

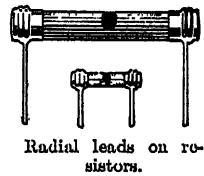

radian That angle which, when placed with its vertex at the center of a circle, intercepts or subtends an arc whose length is equal to the radius of the circle. A complete circle contains 2π radians (since the circumference of a circle is equal to 2π times the radius). One radian is 57.2959 degrees; π radians equal 180 degrees. One degree is 0.01745 radian.

radiance The radiant flux density at an element of the surface of a source of radiant energy.

radian frequency Frequency expressed in radians per unit of time. It is equal to the frequency in cycles multiplied by 2π . Also called *angular frequency*.

radial length The distance, in a sinusoidal wave, between phases differing by an angle of one radian. It is equal to the wavelength divided by 2π .

radian per second The unit of angular velocity.

radiant Emitted or transmitted by radiation.

radiant energy Energy transmitted in the form of electromagnetic radiation such as radio waves, heat waves, or light waves. It is measured in units of energy, such as kilowatt-hours, ergs, joules, or calories.

radiant heat Infrared radiation from a body that is at a temperature not quite high enough to cause visible radiation.

radiate To send out energy, such as radio-frequency waves, into space.

radiating curtain An array of dipoles in a vertical plane, positioned to reinforce each other. It is usually placed one-quarter wavelength ahead of a reflecting curtain of corresponding half-wave reflecting antennas.

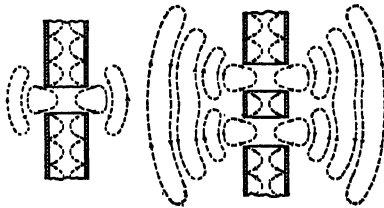

Radiating guides. By cutting away part of the guide at one or more points, loops of electric force (shown dotted) emerge through the gap, break away from the guide, and spread into free space as radiated energy.

radiating guide A wave guide designed to radiate energy into free space. The waves may emerge through slots or gaps in the guide, or through horns inserted in the wall of the guide.

radiating power The time rate of emission of radiant energy in all directions per unit surface area of a radiating body at a given temperature. Also called *emissive power*.

radiation field The electromagnetic field that breaks away from a transmitting antenna and radiates outward into space as electromagnetic waves (radio waves).

radiation pattern A diagram indicating the intensity of the radiation field of a transmitting antenna at a given distance away from the antenna in all

directions. In the case of a receiving antenna, it indicates the response of the antenna to a signal having unit field intensity and arriving from different directions.

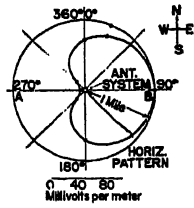

radiation potential The voltage in volts, corresponding to the energy in electron volts required to excite an atom or molecule and cause emission of one of its characteristic radiation frequencies.

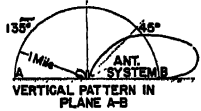

Horizontal and vertical radiation patterns for a directional antenna system consisting of two vertical antennas spaced a quarter wave apart and carrying currents 90 degrees out of phase.

radiation pyrometer An instrument that measures extremely high temperatures by measuring the intensity of the radiation given off by a hot body.

radiation resistance The total radiated power of an antenna divided by the square of the effective antenna current measured at the point where power is supplied to the antenna.

radiation temperature The temperature to which an ideal blackbody must be heated so it will have the same emissive power as the source of thermal radiation being considered.

radiative equilibrium Maintenance of a constant temperature by absorption and emission of radiant energy at the same rates.

radio 1. The art of communication by means of radio waves. Travel of radio waves through free space (space radio) is implied by the term radio, whereas wired radio is used to describe radio waves that are guided intentionally by conductors. 2. Pertaining to, employing, or operated by radiant energy. 3. In chemistry, a combining form used to designate radioactive isotopes, especially those produced artificially by bombardment. Examples are radio-sodium and radiotitanium. 4. Popular name for a radio receiver. 5. A message transmitted by radio, as a

RADIOACOUSTIC POSITION FINDING

radiogram. 6. To send a message by radiotelegraphy. 7. By means of radium, as in radiosurgery. 8. Denoting radial or radially, as in radiodigital and similar medical terms.

radioacoustic position finding A method of determining distances through water by closing a radio circuit at the instant that a charge is exploded under water at one point and calculating the distance to the observing station from the time difference between the arrival of the radio signal and the sound of the explosion transmitted through water.

radioacoustics The study of the production, transmission, and reproduction of sounds carried from one place to another by radiotelephony.

radioactinium A radioactive element formed by the disintegration of actinium. It has an atomic number of 90 and is isotopic with thorium.

radioactivate To make radioactive.

radioactive Pertaining to or exhibiting radioactivity.

radioactive constant A constant associated with a particular substance, determining its rate of disintegration. It is the value of γ in the equation $M_t = M_0 e^{-\gamma t}$, where M_0 is the original mass, M_t is the mass t seconds later, and e is 2.718.

radioactive deposit A film of radioactive matter formed on a solid object that has been subjected to a radioactive emanation such as radon, thoron, actinon, or a subsequent product.

radioactive emanation A gaseous disintegration product of a radioactive material. It forms a radioactive deposit on any solid object exposed to it.

radioactive product A substance resulting from radioactive disintegration of a parent substance.

radioactive series A succession of radioactive elements, each of which is derived from disintegration of the one preceding it. The final element in the series is nonradioactive and is known as the end product.

radioactive transformation Changing one chemical element into another through radioactivity.

radioactivity A property possessed by elements like radium, uranium, thorium, and their products in which alpha or beta particles and sometimes also gamma rays are emitted by disintegration of the nuclei of atoms. Alpha rays are emitted when an atom loses a helium nucleus and changes to an atom having an atomic number two units lower. Beta rays are emitted when the nucleus loses an electron, giving an atom having an atomic number one unit higher.

radio beacon A radio transmitting station in a fixed geographic location, emitting a distinctive or characteristic signal that enables mobile radio stations (on ships or aircraft) to determine bearings, locations, or courses.

radio-beacon station A special station the emissions of which are intended to enable an on-board station to determine its bearing or a direction with reference to the radio-beacon station, and in some cases also the distance that separates it from the latter.

radio bearing The angle between the observed direction of travel of a radio wave and some fixed line such as geographical north or the axis of a vessel. True bearings and courses are given in relation to true north. Magnetic bearings and courses are given in relation to the magnetic north. Relative bearings are given in relation to the lubber line of an aircraft or vessel.

radio broadcast A program of music and/or voice and other sounds broadcast from a radio transmitter for general reception.

radio broadcasting Radio transmission intended for general reception.

radio channel A band of frequencies having sufficient width to permit its use for radio communication. The width of a radio channel depends on the type of transmission and the tolerance for the frequency of emission.

radio circuit 1. A radio system for carrying out one communication at a

RADIO-FREQUENCY AMPLIFIER

time in either direction between two points. 2. An arrangement of parts and connecting wires for radio purposes.

radio communication The transmission by radio of writing, signs, signals, pictures, and sounds of all kinds.

radio compass A radio direction finder used for navigational purposes (AIEE definition). Strictly speaking, it is not a compass because it gives direction with respect to a radio station rather than to the north magnetic pole.

radio control Control of stationary equipment or of unmanned moving objects such as ships, aircraft, or automobiles by means of signals transmitted through space by radio.

radiode A container for radium.

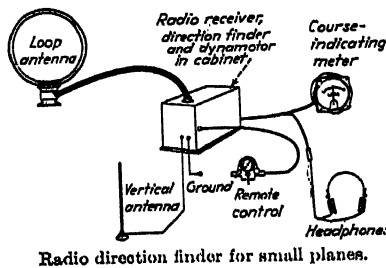

radio direction finder A radio receiving device that can be used to determine the line of propagation of radio waves.

radio direction-finding station A station equipped with special apparatus for determining the direction of the emissions of other stations.

radio engineering That field of engineering dealing with the generation, transmission, and reception of radio waves and with the design, manufacture, and testing of associated equipment. This definition includes television, which is simply radio engineering extended to handle picture signals.

radio fadeout Complete or near-complete absorption of radio waves by those parts of the ionosphere which are affected by a sudden ionospheric disturbance.

radio field intensity The effective value of the electric or magnetic field intensity at a point due to the passage of radio waves of a specified frequency. Usually expressed as the electric field intensity in microvolts or millivolts per meter. Unless otherwise stated, it is measured in the direction of maximum field intensity.

radio field-to-noise ratio The ratio, at a given location, of the radio field intensity of the desired wave to the noise field intensity.

radio fix 1. Determination of the position of the source of radio signals by obtaining cross bearings on the transmitter with two or more radio direction finders in different locations, then computing the position by triangulation. 2. Determination of the position of a vessel or aircraft equipped with direction-finding equipment by obtaining radio bearings on two or more transmitting stations of known location and then computing the position by triangulation.

radio frequency A frequency usually higher than those corresponding to normally audible sound waves and lower than the frequencies corresponding to heat and light waves.

radio-frequency alternator A rotating-type generator for providing high power at radio frequencies generally lower than 100,000 cycles. Used at one time for radio transmitters, but the chief use today is for high-frequency heating.

radio-frequency amplifier A vacuum-tube amplifier stage or section used to increase the voltage or power of radio-frequency signals. In a tuned-radio-frequency receiver, all stages ahead of the detector are radio-frequency amplifier stages (often called simply radio-frequency stages). In a super-

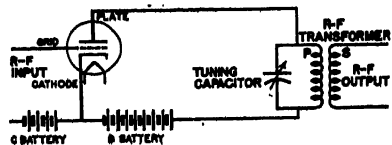

Simplified circuit diagram of a radio-frequency amplifier stage.

RADIO-FREQUENCY CHOKE

heterodyne receiver, a radio-frequency stage is sometimes used ahead of the first detector (in the preselector).

radio-frequency choke An inductor having a high impedance at radio frequencies and using either an air core or a pulverized iron core. Used to block the flow of radio-frequency current while passing lower frequencies or direct current.

radio-frequency current An alternating current having a frequency higher than about 10,000 cycles.

radio-frequency oscillator An oscillator that generates alternating current at radio frequencies.

radio-frequency resistance The total resistance offered by a device in an alternating-current circuit, including resistance due to eddy current, hysteresis, dielectric, and corona losses as well as the direct-current resistance. Also called *alternating-current resistance*, *effective resistance*, and *high-frequency resistance*.

radio-frequency signal generator A test instrument that can be used to generate the various radio-frequency voltages required for alignment and servicing of radio equipment. Also called *service oscillator*.

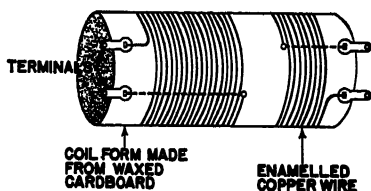

One type of radio-frequency transformer.

radio-frequency transformer A transformer for use with radio-frequency currents. It has either an air core or some other form of pulverized iron core.

radiogenic Produced as a product of radioactivity.

radiogoniometer Part of a radio direction finder. In the Bellini-Tosi system, two loop antennas positioned at right angles to each other are con-

nected to two field coils in the radiogoniometer. Bearings are obtained by a rotatable search coil that is inductively coupled to the field coils.

radiogonioscope An automatic radiogoniometer equipped with a visual indicator giving the direction of incoming signals.

radiogram 1. A message transmitted by wireless telegraphy. 2. A radiograph or X-ray photograph (rarely used). 3. An X-ray pattern produced by crystal diffraction.

radiograph A picture produced on a radiation-sensitive surface by X rays, radium emanations, or other radiation than light, showing the nonuniform density of the structure through which the rays pass. Called *roentgenogram* by some medical authorities, and generally known as an *X-ray photograph*.

radiographer An expert in X-ray photography, usually working under a radiologist.

radiography The art of producing radiographs (X-rays photographs or roentgenograms).

radio interference Undesired disturbance in radio reception, or that which causes the undesired disturbance. It may originate in the transmitter, the transmission medium, or the receiver.

radio landing beam A distribution of radio waves, directional in the vertical plane, for vertical guidance of aircraft during descent to a landing surface.

radio link 1. The transmission of a sound or television program between specific points by means of radio rather than over telephone lines or special transmission lines. 2. A radiotelephone circuit connecting two sections of ordinary wire telephone circuit.

radiolocation British equivalent of radar. It involves determination of the position of a distant object or reflecting surface by a method involving the use of reflected radio waves. Radiolocation techniques are regarded as a branch of telecommunication engineering, although strictly radio-

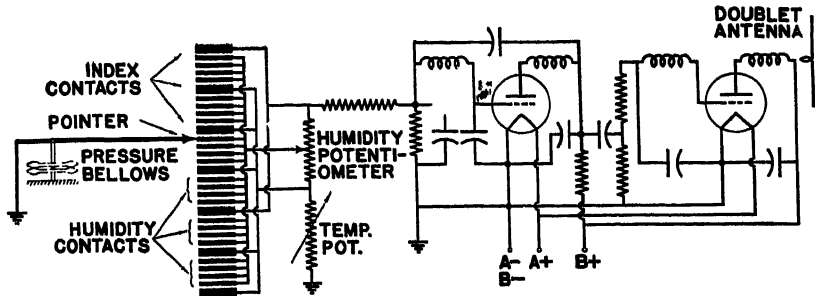

Basic circuit of a typical radiometeorograph.

location may not at present be included in the definition of telecommunication.

radiologist A medical specialist skilled in the use of X rays and/or radioactive substances.

radiology The science that deals with X rays and radioactive substances.

radioluminescence Luminescence produced by radiant energy, as by X rays, radioactive emissions, alpha particles, or electrons.

radio marker beacon A radio beacon used for marking the location of a point, boundary, or small area, usually for aircraft guidance.

radio marker station A station marking a definite location on the ground as an aid to air navigation.

radio metal locator An instrument employing vacuum-tube circuits to detect the presence of metal within its operating range by a change in meter reading or a change in a signal heard in headphones. Extensively used for locating buried explosive mines, buried pipe lines, buried metal objects, guns or other metal objects concealed on persons, metal embedded in logs about to be sawed, etc.

radioman Specifically, a radio operator. The trend is to differentiate between the radioman who is a radio operator and the radio technician who services and maintains radio equipment.

radiomateriology Examination of material for interior cracks and flaws by means of X rays.

radiometallography Examination of the crystalline structure and other characteristics of metals and alloys with X-ray equipment.

radiometeorograph A meteorograph which, when carried into the stratosphere by an unmanned gas-filled rubber balloon, automatically reports atmospheric conditions by radio as it ascends into the stratosphere. The ultrahigh-frequency signals are so transmitted that they can be recorded and interpreted in terms of pressure, temperature, and humidity. Also called *radiosonde*.

radiometer An instrument for measuring the intensity of radiant energy. In one form, a thin disk blackened on one side is suspended by a fine quartz fiber in an evacuated bulb. Absorption of energy by the blackened face produces a repelling action due to a local rise in temperature, and the resulting torsional twist in the fiber is a measure of the intensity of the radiation. In another instrument, the Crookes radiometer, four such blackened disks are arranged like a miniature windmill inside the evacuated bulb. When exposed to sunlight or other radiant energy, the vane spins vigorously to give a qualitative indication of the presence of radiant energy. Other examples are the bolometer, micro-radiometer, Nichols radiometer, and radiomicrometer.

radiometric gage Any low-pressure gas manometer operating on differences in pressure on opposite sides of a suspended vane due to molecular bombardment. The Knudsen gage is an example.

RADIOMETRY

radiometry Measurement of radiation, as with a radiometer.

radiomicrometer A sensitive instrument for measuring radiant energy by allowing the radiation to fall on a thermojunction that forms part of the moving system of a galvanometer. The deflection is a measure of the radiation.

radio navigation The art of conducting the flight of an aircraft from one position to another over the surface of the earth by using radio signals for directional guidance. Two principles are employed: either the radio energy radiated from the transmitter is directional in character, or the receivers that pick up the radiated energy are capable of providing the required directional sense.

radio noise field intensity A measure of the field intensity at a point, as at a radio receiver, of interfering electromagnetic waves.

radiopaque Not penetrable by X rays or other forms of radiation.

radiophare A radiotelegraph station formerly used in determining the position of ships at sea.

radiophone 1. A radio transmitter or receiver, or both combined, used for radiotelephony. 2. Any apparatus for producing sound through the action of radiant energy.

radiophotogram A photograph transmitted by radio.

radiophotography Transmission of photographs by radio.

radio-photoluminescence Luminescence exhibited by minerals such as fluorite and kunzite as a result of irradiation with beta and gamma rays followed by exposure to light.

radiopraxis The employment of radiant energy, such as ultraviolet rays or X rays, in medical practice.

radio prospecting Use of radio equipment in various ways to locate mineral or oil deposits. Certain types of ore deposits can sometimes be located with a radio metal locator.

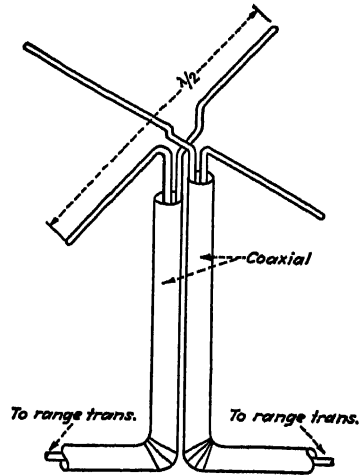

Radio-range antenna for radiating horizontally polarized waves. Each half-wave dipole is fed by a coaxial transmission line going to its own airport radio-range transmitter.

radio range A radio-range beacon. It may produce equisignal zones at various angles for several converging air-line routes.

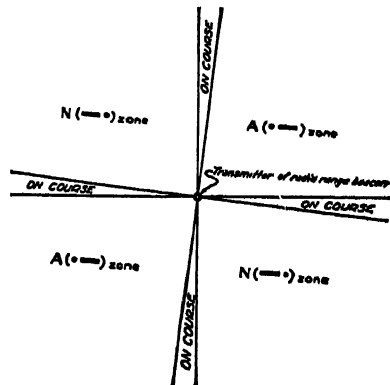

Radio-range beacon course as marked on airway map.

radio-range beacon A radio beacon that transmits directive waves by means of which deviations from a given course may be observed by aircraft.

radio-range monitor An instrument that automatically monitors the signal from a radio-range beacon, giving a warning to attendants when the transmitter deviates a specified amount from its

RADIOTELEPHONE DISTRESS SIGNAL

correct bearings and transmitting a distinctive warning to approaching planes when trouble exists at the beacon.

radio reception Reception of messages, programs, or other intelligence by radio.

radiosensitive 1. Sensitive to radiant energy. 2. Capable of being injured or destroyed by radiant energy, as by X rays.

radio set 1. A radio receiver. 2. A radio transmitter, a radio receiver, or a combination of the two.

radio silence A period during which all scheduled and other radio transmission is foregone by a radio station.

radiosonde A radiometeorograph.

radiosonic Using radio waves for sound-ing purposes.

radio spectrum The entire range of frequencies in which useful radio waves can be produced. These frequencies have been classified into seven bands by the Federal Communications Com-mission, as follows:

Designation	Abbr.	Frequency
very low frequency	vlf	10 to 30 kilocycles
low frequency	l-f	30 to 300 kilocycles
medium frequency	m-f	300 to 3,000 kilo-cycles
high frequency	h-f	3 to 30 megacycles
very high frequency	vhf	30 to 300 megacycles
ultrahigh frequency	uhf	300 to 3,000 mega-cycles
superhigh frequency	shf	3,000 to 30,000 megacycles

Each band starts just above its lower limit and includes its upper limit.

radio station A station equipped to engage in radio communication or radio transmission of energy. A station includes all apparatus used at a particular location for one class of service and operated under a single instrument of authorization. Radio stations are classified according to the nature of the service they furnish.

radio-station interference Selective interference caused by the radio waves of a station or stations other than that from which reception is desired.

radio technician One qualified in all phases of repair and maintenance of radio equipment. Sometimes referred to as a radioman but the trend is away from this usage.

radiotechnology 1. Application of any form of radiation to industrial processes. 2. Application of X rays to industry. 3. The practical art of radio.

radiotelegraph Pertaining to telegraphy over radio channels.

radiotelegraph first-class operator license A commercial radio-operator license issued by the Federal Communications Commission to applicants meeting citizenship and other requirements and passing examinations on code transmission and reception at 25 words per minute plain language and 20 code groups per minute, basic law, basic theory and practice, radiotelegraph, advanced radiotelegraph, and ability to transmit and receive spoken mes-sages in English. The applicant must have had one year of service as a radio-telegraph operator and must be at least twenty-one years of age.

radiotelegraph second-class operator li-cense A commercial radio-operator license issued by the Federal Communi-cations Commission to applicants meeting citizenship and other require-ments and passing examinations on basic law, basic theory and practice, radiotelegraph, advanced radiotele-graph, and ability to transmit and receive spoken messages in English.

radiotelegraph transmitter A radio transmitter that is capable of handling code signals (type A1 and B emissions).

radiotelegraphy Telegraphy employing the International Morse code and carried on by means of radio waves, without connecting wires between stations.

radiotelephone The complete radio transmitter, radio receiver, and asso-ciated equipment required at one station for radiotelephony.

radiotelephone distress signal The word "mayday" (corresponding to the

RADIOTELEPHONE FIRST-CLASS OPERATOR LICENSE

French pronunciation of the expression *m'aidez*), spoken under the same conditions that the signal SOS would be transmitted in code by radiotelegraphy.

radiotelephone first-class operator license

A commercial radio-operator license issued by the Federal Communications Commission to applicants meeting citizenship and other requirements and passing examinations on basic law, basic theory and practice, radiotelephone, advanced radiotelephone, and ability to transmit and receive spoken messages in English.

radiotelephone second-class operator license

A commercial radio-operator license issued by the Federal Communications Commission to applicants meeting citizenship and other requirements and passing examinations on basic law, basic theory and practice, radiotelephone, and ability to transmit and receive spoken messages in English.

radiotelephone transmitter A radio transmitter capable of handling audio-frequency modulation, such as voice and music.

radiotelephony Two-way voice communication (telephony) carried on by means of radio waves, without connecting wires between stations.

radio-thermoluminescence Luminescence exhibited by certain vitreous and crystalline substances as a result of irradiation with beta and gamma rays followed by heating.

radiotherapy Diathermy involving the use of high frequencies.

radio transmission The transmission of signals through space at radio frequencies by means of radiated electromagnetic waves.

radio transmitter A device for producing radio-frequency power, for purposes of radio transmission. Examples are spark transmitter, alternator transmitter, vacuum-tube transmitter, amplitude-modulation transmitter, phase-modulation transmitter, frequency-modulation transmitter, single-sideband transmitter, and vestigial-sideband transmitter.

radiotransparent Permitting passage of X rays or other forms of radiation.

Radiotrician Trade-mark name applied to a person who has received training in radio from National Radio Institute.

Radiotron Trade-mark name used for vacuum tubes manufactured by Radio Corporation of America.

radiotropism Turning or curvature of a plant or other organism in response to some form of radiation.

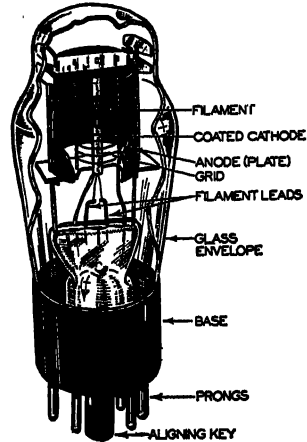

Cutaway diagram showing construction of a typical radio tube.

radio tube This is a general term covering any type of electron tube that may be used in electronic equipment.

radiovision Early name for television.

radiovisor 1. Early name for a device that reconstructs the image in a television receiver. 2. In Great Britain, a name adopted for photoelectric illumination controls, photoelectric burglar alarms, and similar photoelectric relay devices.

radio watch The service performed by a qualified operator when on duty in the radio room of a vessel listening for signals of other stations on the international calling and distress frequency 500 kilocycles, and at all other times when such operator is engaged in transmitting or receiving signals or messages on any authorized frequency,

to or from any station in the maritime mobile service, or in receiving from any station time signals, weather reports, hydrographic reports, reports regarding aids to navigation, authorized press material, or information regarding the safety of life or property at sea. Also called simply *watch*.

radio wave An electromagnetic wave produced by oscillations (rapid reversals of current flow) at a radio-frequency rate in a conductor. Such a wave travels through space at essentially the speed of light and may carry modulation in the form of an intelligence signal. Originally called *Hertzian wave*.

radio wave-front distortion A change in the direction of advance of a radio wave.

radio-wave propagation The transfer of energy by electromagnetic radiation at radio frequencies.

radium A highly radioactive metallic element that gives off three kinds of radiation: alpha rays, beta rays, and gamma rays. The radioactivity is an atomic property resulting from disintegration of the radium atom.

radiumtherapy The treatment of disease by the use of radium or its emanations.

radius The distance from the center of a circle or arc to the circumference.

radon The gaseous radioactive product formed by the expulsion of an alpha particle from radium.

Raman effect An effect observed when a beam of light is passed through a pure liquid or vapor, in which the emerging scattered light contains frequencies that differ from those in the incident light by various values that are characteristic of the scattering substance, but independent of the incident frequency. Discovered by C. V. Raman, Indian physicist, in 1928. It is analogous to the Compton effect for X rays.

Raman spectrum The scattered or modified spectrum lines that constitute

the new frequencies produced by the scattering material in the Raman effect.

Ramsauer effect Absorption of slow-moving electrons by intervening matter.

Ramsden eyepiece An eyepiece for optical instruments, consisting of two similar plano-convex lenses separated a distance equal to two-thirds the focal length of either, with the convex surfaces facing each other.

random noise Electrical disturbances of nonuniform and irregular amplitude, phase, and frequency, in the radio-frequency spectrum.

random winding A coil winding with the turns positioned haphazardly, not in layers.

range 1. Extent of coverage or effectiveness. 2. A measure of distance.

Raphael bridge A type of slide-wire bridge used in loop tests for locating faults in transmission lines. The scale of the slide wire is graduated to read the distance to the fault directly in yards.

rare gas One of a group of chemically inert gases, including argon, helium, krypton, neon, and xenon. Also called *inert gas* or *noble gas*.

rated output The output power, voltage, current, etc., at which a machine, device, or apparatus is designed to operate under specified normal conditions.

rating A designated limit of operating characteristics for a machine, apparatus, or device, based on definite conditions.

ratio arms Two adjacent arms of a Wheatstone bridge, having adjustable resistances so arranged that the two arms can be set to have any of several fixed ratios to each other.

ratio of transformation The ratio of the secondary voltage of a transformer to the primary voltage under no-load conditions, or the corresponding ratio of currents in a current transformer.

ratiometer 1. An instrument for measuring the ratio of transformation of a

RAY-LOCKING DEVICE

transformer, by means of a resistance-bridge arrangement. 2. A moving-coil type of instrument in which the deflection is proportional to the ratio of the currents sent through two coils.

ray-locking device An electrostatic or other arrangement used in a cathode-ray oscillograph to deflect the electron beam away from the photographic film before and after the beam has made the desired recording on the film.

ray of light A single element of light propagated in a straight line and having infinitesimally small cross-section, used for tracing the path of light through an optical system.

Rayleigh cycles Cycles of magnetization that do not extend beyond the initial portion of the magnetization curve and are, hence, between zero and the upward bend. In this region the permeability is low and there is no hysteresis.

Rayleigh law At very low values of maximum magnetic induction, the hysteresis loss in a magnetic cycle is proportional to the cube of the magnetic induction.

Rayleigh line That spectrum line in scattered radiation which has the same frequency as the corresponding incident radiation. It arises simply from ordinary or Rayleigh scattering, not from the Compton effect or the Raman effect.

Rayleigh scattering Selective scattering of light by very small particles suspended in air, as by dust.

RCA Abbreviation for Radio Corporation of America.

RCA licensed Manufactured under a licensing agreement that permits use of patents owned by the Radio Corporation of America.

RC constant The time constant of a resistor-capacitor circuit, equal in seconds to the resistance value in ohms multiplied by the capacitance value in farads.

RC coupling Resistor-capacitor coupling between two circuits.

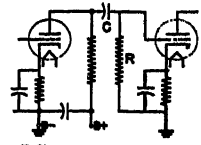

RC coupling in an amplifier.

rcg circuit Abbreviation for reversion-controlled gain circuit.

reactance The opposition in ohms offered to the flow of alternating current by inductance or capacitance in a circuit. It is that component of the impedance of a circuit which is not due to resistance. Inductive reactance is due to inductance, and its value in ohms is equal to $2\pi fL$, where f is the frequency in cycles and L is the inductance in henrys. Capacitive reactance is due to capacitance, and its value in ohms is equal to $1/2\pi fC$ where C is the capacitance in farads.

reactance modulator A modulator stage used in frequency-modulation transmitters and in panoramic adapters to accomplish frequency modulation by operating a vacuum tube in such a way that it acts as a reactance that varies in accordance with the intelligence modulation, causing the frequency of the oscillator stage to vary accordingly. The same general principles have been used in automatic frequency-control circuits.

reaction Another name for regeneration.

reaction indicator A device used to determine resonance by observing the effect of resonance on the reflections in an oscillating system.

reactivation of a filament Application of a higher voltage than normal to a thoriated filament for a few seconds, to bring a fresh layer of thorium atoms to the filament surface and thereby improve electron emission.

reactive Pertaining to either inductive or capacitive reactance. A reactive circuit has a high value of reactance in comparison with resistance.

reactive factor The ratio of reactive power to apparent power.

reactive load A load having reactance, such as a capacitive load or an inductive load.

RECEIVING STATION

reactive power The product obtained by multiplying the effective value of current, effective value of voltage, and the sine of the angular phase difference between current and voltage, when these quantities are sinusoidal. The result is in vars, the unit of reactive power, if the current is expressed in amperes and the voltage in volts.

reactive volt-ampere-hour meter An electricity meter for measuring and registering reactive volt-ampere-hours. Also called *var-hour meter*.

reactive volt-ampere meter An instrument for measuring reactive volt-amperes. Also called *var meter*.

reactive volt-amperes That component of the apparent power in an alternating-current circuit which is delivered to the circuit during part of a cycle but is returned to the source during another part of the cycle. Sometimes called *wattless power*. The practical unit of reactive power is the var, equal to one reactive volt-ampere.

reactor A device that introduces reactance (either inductive or capacitive) into a circuit.

real image An optical counterpart of an object, produced on a surface at which light rays converge after passing through a lens.

real power That component of the apparent power (volt-amperes) in an alternating-current circuit that represents true work. Expressed in watts. Equal to the volt-amperes multiplied by the power factor.

Reaumur scale A temperature scale in which the freezing point of water is 0° and the boiling point 80°, still used to some extent in France, Germany, and Russia. Abbreviated R. To convert R readings to centigrade readings, multiply by $\frac{5}{4}$. To convert R to Fahrenheit, multiply by $\frac{9}{4}$ and add 32.

rebroadcast Reception of the program of a radio station, and the simultaneous or subsequent retransmission of such program by a broadcast station.

receiver 1. The complete equipment required for receiving radio waves and converting them into the original intelligence, such as into sounds or pictures. 2. In general, the equipment for reception of any incoming electrically transmitted signals or messages. 3. In telephony, the sound-reproducing device that is held to the ear.

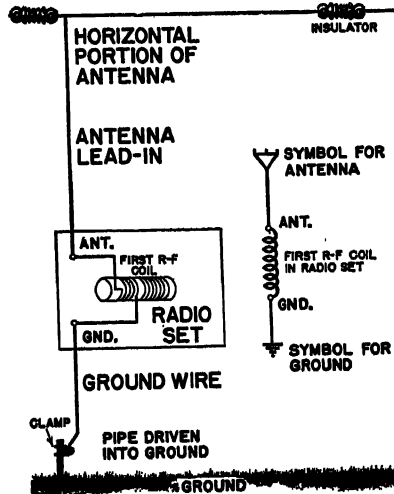

Receiving antenna, with schematic symbol and names of important parts.

receiving antenna An antenna used for the reception of radio signals. It serves to convert the arriving electromagnetic waves into corresponding modulated radio-frequency currents that flow through the antenna circuit.

receiving circuit The apparatus and connections used exclusively for the reception of messages at a radio-telephone or radiotelegraph station.

receiving perforator An apparatus used in printing telegraph systems to punch a paper strip in accordance with arriving signals, permitting reproduction of the signals as printed messages when the paper strip is later passed through a printing telegraph machine.

receiving station A station used for reception of radio signals or messages.

RECEPTACLE

receptacle A socket or outlet into which a plug can be pushed or screwed for the purpose of making electrical connections. When mounted in the wall of a building and connected to power-line wiring, it is sometimes called a wall outlet or convenience receptacle.

receptacle outlet An outlet intended to be equipped with one or more receptacles, not of the screw-shell type, into which plugs of appliance cords may be inserted.

reciprocal-energy theorem A theorem due to Rayleigh: If an electromotive force E_1 in one branch of a circuit produces a current I_2 in any other branch, and if an electromotive force E_2 inserted in this other branch produces a current I_1 in the first branch, then $I_1E_1 = I_2E_2$. This is closely related to the reciprocity theorem.

reciprocal impedance Two impedances Z_1 and Z_2 are said to be reciprocal impedances with respect to an impedance Z (invariably a resistance) if they are so related as to satisfy the equation $Z_1Z_2 = Z^2$.

reciprocation The process of deriving a reciprocal impedance from a given impedance.

reciprocity theorem If an electromotive force E at one point in a network produces a current I at a second point in the network, then the same voltage E acting at the second point will produce the same current I at the first point.

reclosing relay A relay that functions to reclose a circuit automatically under certain conditions.

recoil The motion of an atom due to emission of an alpha particle, a beta particle, a neutron, or possibly a quantum of radiation.

recombination coefficient In an ionized gas, the value obtained by dividing the time rate of recombination of ions by the product of the positive-ion density and the negative-ion density.

record A commercial phonograph pressing. The term is sometimes also applied to instantaneous recording disks.

recorder An instrument that makes a graphic record of the manner in which the value of a quantity varies with time. Also called a *recording instrument*. The essential parts are a marking device, an arrangement for moving the marking device in accordance with changes in the quantity under study, a motor or other device for driving the chart at a controlled speed, and the parts necessary to carry the chart. In a sound-on-film recorder, the action of light on movie film produces the record or sound track. Mechanical sound recorders cut or emboss a groove in wax or other material. Facsimile recorders produce a graphic record on paper. A code recorder records code messages as punched holes or inked lines on paper tape.

recording 1. In facsimile, the process of registering the received signal on the record sheet. It may be photographic, electrochemical, electrolytic, electrothermal, electromechanical, carbon-pressure, or ink-vapor recording. 2. The mechanical process of producing a permanent physical record of sounds or other varying quantities. 3. A phonograph record.

recording blank A recording disk.

recording disk An unrecorded or blank disk made for recording purposes. Also called *recording blank*. The recorded disk is called an *instantaneous recording*.

recording head The cutting head of a sound recorder.

recording instrument An instrument that makes a graphic record of the manner in which the value of a quantity varies with the time. Also called *recorder*.

recording lamp A light source so designed that its intensity can be varied in accordance with variations of an audio-frequency signal sent

through the lamp. Used in the variable-density system of sound recording on movie film.

recording level The amplifier output level required to secure a satisfactory recording.

recording spot The instantaneous area acted on by the registering system of a facsimile recorder.

record player A device for converting a phonograph record into corresponding sound. In a typical arrangement, the record is placed on a turntable that is rotated by a spring or electric motor. A carefully shaped needle riding in the record grooves actuates a crystal or magnetic phonograph pickup that converts groove variations into corresponding audio-frequency signals. These are fed to a separate audio-frequency amplifier or to the audio-frequency section of a radio receiver for amplification before they can be reproduced as sound by a loudspeaker.

rectangular wave guide A wave guide having a rectangular cross-section.

rectification The process of converting alternating current into a current that flows in only one direction.

rectification factor The change in the average current of an electrode, divided by the change in the amplitude of the alternating sinusoidal voltage applied to the same electrode, while the direct voltages of this and other electrodes are maintained constant.

rectifier A device that converts alternating current into unidirectional

current (direct current) by permitting appreciable current flow in one direction only.

rectifier instrument A combination of a direct-current meter with a rectifying device (usually a copper-oxide rectifier) for measuring alternating currents or voltages.

rectifier stack A dry-disk rectifier made up of layers or stacks of disks of individual rectifiers, as in a selenium rectifier or copper-oxide rectifier.

rectifying detector A vacuum tube or crystal detector that operates by passing only those half-cycles of the incoming carrier signal that are all in the same direction, so that they have a cumulative effect on the sound-reproducing device instead of canceling out.

Rectigon A two-electrode thermionic vacuum tube used as a rectifier for charging storage batteries from alternating-current lines. It contains a tungsten filament and graphite anode in an argon-filled bulb.

rectilineal compliance The mechanical element that opposes a change in the applied force, such as the springiness that opposes a force acting on the diaphragm of a loudspeaker or microphone.

rectilinear scanning The process of scanning an area in a predetermined sequence of narrow parallel strips.

rediffusion A form of wire broadcasting used extensively in Great Britain, in which a radio program is picked up from a broadcast station and distributed to the loudspeakers of subscribers over telephone or other wire circuits.

reed frequency meter A vibrating-reed type of instrument for measuring frequency.

reentrant Having one or more sections directed inward, as in certain types of resonating cavities.

reentrant winding An armature winding that returns to its starting point, thus forming a closed circuit.

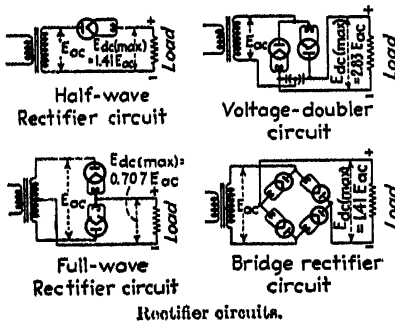

REFERENCE LEVEL

reference level The level used as a starting point when designating the value of an alternating quantity or a change in the quantity by means of decibel units. A common reference value in voltage, current, and power designations is 0.006 watt for 0 decibels. For sound loudness, the reference level is usually the threshold of hearing. For communications receivers, the commonly used level is 60 microwatts.

reference recording Recording of a radio program for future reference or checking.

reflectance The ratio of the total luminous flux reflected by a given surface to the incident flux. Also called *reflection factor*.

reflected impedance The impedance value that appears to exist across the primary of a transformer when an impedance is connected as a load across the secondary.

reflected resistance The resistance value that appears to exist across the primary of a transformer when a resistive load is across the secondary.

reflected wave 1. The sky wave, reflected from an ionosphere layer back to the earth. 2. Any wave reflected from a surface or from the junction of two different mediums.

reflecting curtain A vertical array of half-wave reflecting antennas, generally used one-quarter wavelength behind a radiating curtain of dipoles to form the pine-tree array.

reflecting electrode The tubular outer electrode in a microwave oscillator tube, corresponding in construction but not in function to the plate of an ordinary triode. Used for generating extremely high frequencies.

reflecting galvanometer A galvanometer in which a small mirror attached to the moving element reflects a beam of light onto a scale or reflects an image of a scale into a telescope.

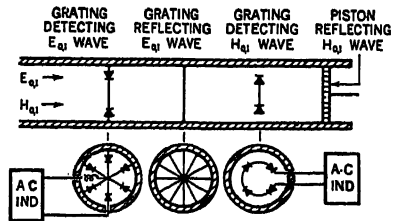

Reflecting grating used to permit simultaneous reception of two waves in a wave guide. The grating of radial wires (shown in cross-section below) reflects the $E_{0,1}$ wave back to its detecting grating for conversion to usable form by crystal detectors. The other wave passes through the radial wires to the piston, which reflects it to the other detecting grating.

reflecting grating An arrangement of wires placed in a wave guide to reflect one desired wave while allowing one or more other waves to pass freely. In simultaneous reception of two waves, the reflecting grating can completely reflect one wave back to the first detecting grating, while the other wave passes through both these gratings to a piston that reflects it back to another detecting grating.

reflection 1. The return or change in direction of particles or waves after impinging on surfaces, such as reflection of light, sound waves, radio waves, or electron streams. If the reflecting surface is smooth in the sense that its inequalities are small in comparison with the wavelength of the incident rays, each incident ray gives rise to a reflected ray in the same plane; this is known as regular, specular, or mirror reflection. The angle between the reflected wave or ray and the perpendicular to the surface is the angle of reflection. In diffuse reflection, the roughness of the surface is so fine and even that reflected rays are distributed in all directions in a definite mathematical manner according to the cosine law. In irregular rough surfaces, spread or mixed reflection occurs, this being intermediate between regular and diffuse reflection. 2. In a transmission line, reflection occurs at a terminating device when the impedance match is incorrect, causing standing waves on the line.

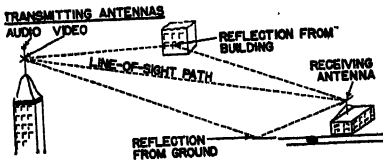

Reflection paths in a television system.

reflection altimeter An aircraft altimeter depending on the reflection of sound, supersonic waves, or radio waves from the earth for the determination of altitude.

reflection coefficient 1. The ratio of a quantity in the reflected wave to the same quantity in the incident wave. 2. The square root of the reflectivity of a surface for any type of radiation. 3. The reflection coefficient at the junction of a source of power and an absorber of power is unity minus the ratio of the current actually received to the current that would be received if the impedance of the absorber of power were equal to the impedance of the source of power. The reflection coefficient is also equal to

$$(Z_A - Z_S) / (Z_A + Z_S),$$

where Z_S is the impedance of the source and Z_A is the impedance of the absorber of power.

reflection factor 1. The ratio of the load current that would be delivered by a particular generator to a particular load without matching to the load current obtained when generator and load impedances are matched. Also called *mismatching factor* or *transition factor*. 2. The ratio of the total luminous flux reflected by a given surface to the incident flux. Also called *reflectance*.

reflection law The angle of incidence is equal to the angle of reflection.

reflection loss The loss of power occurring for a given frequency at the junction of a source and an absorber of power, as at a transformer or at any other point where the characteristics change. When Z_A is the impedance of the absorber and Z_S is the impedance of the source of power at the given frequency, the reflection

loss in decibels is

$$20 \log_{10} \frac{Z_A + Z_S}{\sqrt{4Z_S Z_A}}$$

reflection sounding Echo depth sounding, in which reflection of sound waves or supersonic waves from the bottom of the ocean is utilized in electronic methods of measuring depth.

reflectivity The fraction of incident radiant energy that is reflected.

reflectometer An instrument for measuring the reflection factor or reflectance of a reflecting surface.

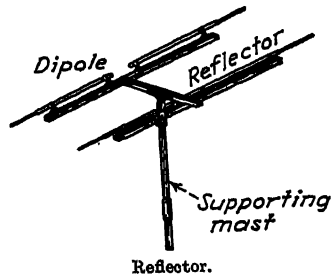

Reflector.

reflector 1. In a directional antenna system, the reflector is the rear portion and is not generally connected to the remainder of the antenna. It serves to increase the effectiveness of the antenna in the forward direction. Complicated and carefully designed structures are used as reflectors in ultrahigh-frequency radio systems. 2. A polished reflecting surface used in illumination to change the direction of light rays or concentrate them in a desired direction. 3. In a reflex klystron, the electrode that reverses the direction of the electron beam and returns the electrons through the resonator grids a second time. 4. Any device capable of reflecting radiant energy such as light, radio waves, or electron streams.

reflector voltage The voltage between the reflector electrode and the cathode in a reflex klystron.

reflex circuit A circuit in which the signal is amplified, both before and after detection, in the same amplifier tube or tubes.

REFLEX KLYSTRON

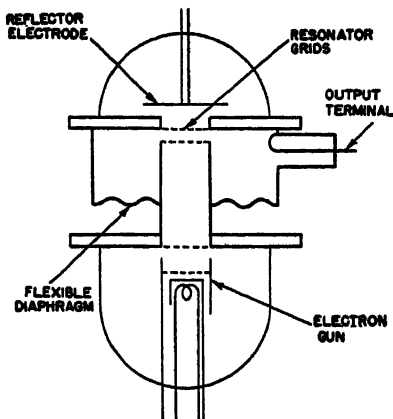

Reflex klystron, a simple form of velocity-modulation tube.

reflex klystron A velocity-modulation tube serving as an oscillator and obtaining feedback because the bunched electron beam is reflected back through the resonator.

refracted wave The wave caused by the refraction (bending) of part of an incident wave that travels into the second medium of propagation, as in traveling from the atmosphere into an ionized layer of the stratosphere.

refraction The change in direction (bending) of a ray of light, heat, sound, or a radio wave or other radiant energy passing obliquely from one medium to another in which the velocity of propagation is different. Thus, light rays are bent in passing from air to water. The angle between the direction of a refracted emission and the normal to the refracting surface is called the angle of refraction.

refractive index The ratio of the speeds of a light ray or other radiation in two different materials. It determines the amount the ray will be refracted or bent when passing from one material to the other, such as from air to water.

refractivity The refractive index minus 1.

refractometer An instrument for measuring the refractive index of a liquid or solid, usually by measuring the

critical angle at which total reflection occurs.

refractor A device, usually of prismatic glass (clear glass fabricated as a series of prisms), which redirects the light of a lamp in desired directions principally by refraction.

refrangible Capable of being refracted.

regeneration The process by which a part of the power in the output circuit of an amplifying device reacts on the input circuit in such a manner as to reinforce the initial power, thereby increasing the amplification. It can occur in an amplifier tube when the plate circuit is coupled to the grid circuit of the same tube or a preceding tube in such a way that a signal is fed back in phase with the signal in the grid circuit. Also called *positive feedback*, *reaction*, *regenerative feedback*, or *retroaction* (British).

regeneration control A variable capacitor, variable inductor, potentiometer, or rheostat used in a regenerative receiver to control the amount of feedback and thereby keep regeneration within useful limits.

regenerative amplification Amplification that gives increased gain and selectivity by a feedback arrangement similar to that used in a regenerative detector. The signal is sent back through the same tube for additional amplification, but operation is always kept just below the point of oscillation.

regenerative braking A system of dynamic braking in which the traction motors are used as generators and return energy to the power-supply system.

regenerative detector A vacuum-tube detector circuit in which radio-fre-

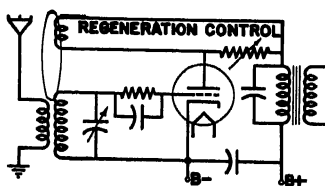

Regenerative detector circuit.

quency energy is fed back from the plate circuit to the grid circuit in such a way as to produce regeneration, thereby greatly increasing the amplification and sensitivity of the circuit.

regenerative feedback Regeneration.

regenerative receiver A radio receiver employing a regenerative detector.

regional channel A standard broadcast channel in which several stations may operate with powers not in excess of 5 kilowatts. The primary service area of a station operating on any such channel may be limited, as a consequence of interference, to a given field-intensity contour.

register To match exactly, or to make a design or mark pass through a machine at a definite position. Register is required whenever two or more colors are used in printing, to make the several impressions correspond exactly.

register control A device used to provide automatic register. In photoelectric register control, a light source and phototube form a scanning head so arranged that the amount of light reaching the phototube changes whenever a specially printed mark or a part of the design (printed on the continuous web of paper) arrives at the scanning head. If this controlling design is not in the correct position, correction is made automatically by apparatus actuated by the phototube through amplifiers and relays.

regular In a definite direction, not diffused or scattered, when applied to reflection, refraction, or transmission.

regular reflection Reflection of light, sound or radio waves from a surface so smooth that its inequalities are small in comparison with the wavelength of the incident rays, so that each incident ray gives rise to a reflected ray in the same plane. Also called *specular reflection*.

regulation Keeping constant some condition like speed, temperature, voltage, or position by means of an electronic or other system that automatically

corrects errors by feeding back into the system the condition being regulated. Regulation thus is based on feedback, whereas control is not. Electronic control, for instance, adjusts a condition through some influence not connected with that condition at all. Detection of off-size objects on a conveyer and consequent removal of them would be automatic control.

regulator A device that functions to maintain a desired characteristic, such as voltage, speed, power factor, frequency, or load, at a predetermined value or vary it according to a predetermined plan.

Reinartz crystal oscillator A crystal-controlled vacuum-tube oscillator in which the crystal current is kept low by placing in the cathode lead a resonant circuit tuned to half the crystal frequency. The resulting regeneration at the crystal frequency improves efficiency without the danger of uncontrollable oscillation at other frequencies.

reinsertion of carrier Combining a locally generated carrier signal in a receiver with an incoming signal of the suppressed-carrier type.

rejector circuit A name sometimes given to a parallel resonant circuit that is tuned to the frequency of an undesired signal and connected to suppress or reject that signal.

rel A unit of reluctance, equal to one ampere-turn per magnetic line of force.

relative bearing A bearing given in relation to the lubber line or major axis of the aircraft or vessel from which the bearing is taken. A true bearing is given in relation to true geographic north, while a magnetic bearing is given in relation to magnetic north.

relative humidity The ratio of the amount of water vapor actually present in air to the greatest amount that can be present at a given temperature, expressed as a percentage. At 100 per cent humidity, the vapor condenses as a liquid.

RELATIVITY

relativity A modern system of natural philosophy introduced and largely developed by Albert Einstein and characterized by its recognition of the interdependence of matter, space, and time. It includes a mathematical development of two postulates: (1) If two systems are moving with uniform but different linear velocities, it is impossible for observers in either system to learn anything more about the motion than the fact that relative motion does exist. (2) Measurements of the velocity of light will give the same numerical value in either moving system.

relaxation inverter An inverter that uses a relaxation oscillator circuit to convert direct-current power to alternating-current power.

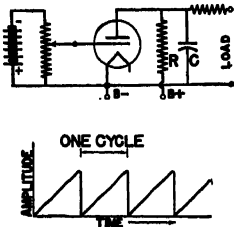

Relaxation oscillator circuit and saw-tooth wave form it produces.

relaxation oscillator 1. An oscillator in which the frequency is controlled by the charge or discharge of an inductor or capacitor through a resistor. 2. A multivibrator oscillator circuit employing two tubes (or a double-section tube) with resistance-capacitance coupling between the tubes to feed the output back and forth between them. The output frequency is determined by the time constant of the coupling networks, but the frequency can readily be controlled externally by a weak signal introduced in the circuit. Used in television circuits to generate sweep voltages for cathode-ray tubes.

relay A device that is operated by a variation in the conditions in one electric circuit and that changes the operation of other devices in the same or in other electric circuits. The most common type of relay is an electro-

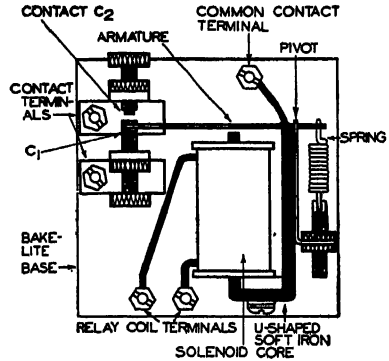

Relay construction.

mechanical device by means of which a current change in one circuit produces an armature movement that opens or closes contacts to produce a change in the electrical condition of another circuit.

relay broadcast station A station licensed to transmit, from points where wire facilities are not available, programs for broadcast by one or more broadcast stations, or orders concerning such programs.



Relay stations for television, sound broadcasting, or communications networks.

relay contacts Contacts that are closed or opened by the movement of the armature of a relay.

relay magnet A coil and iron core forming an electromagnet that attracts the armature of a relay when energized, causing opening or closing of relay contacts.

relay rack A frame on which relays are mounted.

relay transmitter A transmitter that regularly rebroadcasts a sound or television program received at the transmitter station, in order that the program can be passed on to another station outside the range of the originating station. Television networks employ relay transmitters in this manner. Also called *repeater station*.

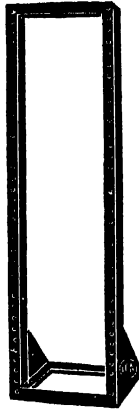

Relay rack, usually either 3 or 6 feet high.

release An electromagnetic device for opening a circuit breaker automatically or for allowing a motor starter to return to its off position when tripped by hand, an interruption of the power supply, or by excessive current.

reluctance The reciprocal of permeance, and hence equal to magnetomotive force divided by magnetic flux for a portion of a magnetic circuit.

reluctivity The ratio of the magnetic intensity H in a region to the magnetic induction B in the same region. Reluctivity is the reciprocal of magnetic permeability. Also called *specific reluctance*.

remanence The magnetic induction that remains in a magnetic circuit after the removal of an applied magnetomotive force.

remanent magnetization The magnetization I retained by a substance when the magnetic intensity H is reduced to zero during a symmetrical hysteresis cycle.

remote control 1. The control of a device from a distance. 2. Producing a radio program at some remote point, relaying it to the studio on a wire or short-wave channel, and controlling it entirely from the studio.

remote cutoff Requiring a very large negative bias for complete cutoff of plate current in a vacuum tube.

remote cutoff tube A vacuum tube designed in such a way that a very large negative grid bias voltage is required for complete blocking of plate current.

remote metering Registering on a meter at a central control point the energy consumption at some other point in a system.

remote pickup Picking up a program with microphones at a remote location (away from the studios) and transmitting it to the studio or transmitter over telephone lines or over a short-wave radio link.

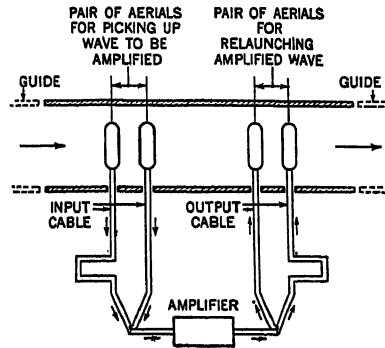

Repeater for wave guide. One pair of antennas projects into the guide to pick up the incoming wave and to convert its energy into a signal that can be amplified. The amplifier feeds its output to another pair of antennas that send the strengthened waves on through the guide.

repeater 1. A vacuum-tube amplifier inserted in a long telephone or telegraph line to build up signal strength before it drops below the noise level of the line. Repeaters must be inserted at regular intervals in transcontinental lines. 2. A relay inserted in a long telegraph line to respond to weak signals and produce new strong signals for the next section of line. 3. A repeating coil. 4. A radio relay transmitter for boosting signal strength in a radio link between stations of a network. 5. In wave-guide work, an arrangement inserted in a guide to

REPEATER STATION

regenerate in amplified form the incoming wave to which it is tuned. A repeater, in general, contains two resonating cavities. One is equipped with a pickup device, and is connected to an incoming guide; the other is equipped with a launching device and is connected to an outgoing guide. An amplifier is connected between the pickup and launching devices and positioned either inside or outside the guides.

repeater station 1. A station at which a repeater is located for the purpose of building up the strength of a telephone or telegraph signal in a long line. 2. A radio station that operates on the same frequency as another station and carries the same program, giving increased coverage. 3. A combination radio transmitter and receiver, often unattended, used in relaying a program from one station to another by radio when the distance is too great for reliable service between the stations directly. Generally employed at frequencies above 100 megacycles. Also called *relay transmitter*.

repeating coil A transformer, usually having a 1:1 ratio, used to provide inductive coupling between two sections of a telephone line when a direct connection is undesirable, as in lines carrying both telephone and telegraph signals.

repeat point In a superheterodyne receiver, the reception of a given station at two different local oscillator frequency values: (1) with the local oscillator adjusted above the incoming signal frequency by the intermediate-frequency value, and (2) with the local oscillator adjusted below the incoming signal frequency by the intermediate-frequency value. Also called *double-spot tuning*.

reproducing stylus The phonograph needle or sapphire jewel used in a phonograph pickup to transmit record groove variations to the pickup as mechanical motion.

reproduction speed In facsimile, the area of copy recorded per unit time.

repulsion A mechanical force tending to separate bodies having like electrical charges or like magnetic polarity, or in the case of adjacent conductors, having currents flowing in opposite directions.

repulsion-induction motor An alternating-current motor that starts up as a repulsion motor by means of a conventional repulsion motor winding with a commutator and brushes on the rotor, then runs normally at rated speed as an induction motor by means of a squirrel-cage winding in the rotor, with all commutator bars short-circuited together.

repulsion motor A single-phase motor having a stator winding (around stationary field poles) connected directly to the source of alternating-current power and a rotor winding connected to a commutator. There is no connection between stator and rotor windings. Brushes on the commutator are short-circuited and are positioned to produce the rotating magnetic field required for starting and running. This type of motor varies considerably in speed as load is changed.

repulsion-start motor An induction motor designed to be started as a repulsion motor.

reradiation Radiation from a receiving antenna of signals generated locally in a radio receiver, causing undesirable interference or revealing the position of the receiver when used on a vessel at sea.

rerecording Making a copy of a phonograph record.

residual charge The charge remaining on the plates of a capacitor after an initial discharge of the capacitor.

residual field The magnetic field left in the iron field structure of a rotating electrical machine after excitation has been removed.

residual gases The small amount of various gases remaining in a vacuum tube even after the best possible exhaustion by vacuum pumps.

residual induction. The magnetic induction at which the magnetizing force is zero when a magnetic material is being magnetized cyclically by two magnetizing forces that are equal and of opposite sign.

residual ionization Ionization of air or other gas in a closed chamber, not accounted for by recognizable neighboring agencies. It is now attributed to cosmic rays.

residual magnetic induction The magnetic induction remaining in a ferromagnetic object after the magnetizing force is removed. The amount depends on the material, shape, and previous magnetic history.

residual magnetism Residual magnetic induction.

resistance That property of a circuit or body which determines the rate at which electric energy is converted into heat or radiant energy by a given current. More generally, it is the opposition that a device or material offers to the flow of current. Resistance is measured in ohms and designated by *R*.

resistance box A box containing a number of precision resistors having carefully selected values, connected to panel terminals in such a way that a variety of resistance values can be obtained between the output terminals either by withdrawing plugs (as in a post-office bridge) or by setting multiconact switches. The most common form is called a decade resistance box.

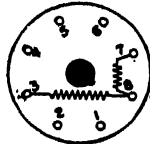

Symbol for a resistance tube, used in universal a-c/d-c receivers for filament voltage-dropping purposes.

resistance braking A system of dynamic braking in which the traction motors are used as generators, feeding resistors that dissipate the energy as heat. Also called *rheostatic braking*.

resistance bridge The common form of Wheatstone bridge, employing resistances in the three arms.

resistance-capacitance coupled amplifier A vacuum-tube amplifier employing resistance-capacitance coupling.

resistance-capacitance coupling The coupling of two vacuum-tube stages or circuits by means of a resistor and capacitor, with the capacitor providing the path for signal currents between stages. Sometimes incorrectly called resistance coupling.

resistance-coupled amplifier A vacuum-tube amplifier in which a resistor provides a path for signal currents from one stage to the next. This term is often incorrectly applied to a resistance-capacitance coupled amplifier.

resistance coupling Resistive coupling, as used in a resistance-coupled amplifier.

resistance drop The voltage drop occurring between two points on a conductor due to the flow of current through the resistance existing between those points. Multiplying the resistance in ohms by the current in amperes gives the voltage drop in volts.

resistance furnace An electric furnace in which the heat is developed by the passage of current through a suitable resistor, which may be the charge itself, a resistor imbedded in the charge, or a resistor surrounding the charge. Examples are the resistor furnace and charge-resistance furnace.

resistance loss Power loss due to current flowing through resistance. Its value in watts is equal to the resistance in ohms multiplied by the square of the current in amperes.

resistance material Any material having sufficiently high resistance per unit length or volume to permit its use in the construction of resistors. Examples are Nichrome, manganin, carbon, etc.

resistance pad A pad employing only resistances. Used to provide a fixed amount of attenuation without altering the frequency response.

resistance standard A resistor that has been adjusted with high accuracy to

RESISTANCE STRAIN GAGE

a specified value. It is but slightly affected by variations in temperature, and retains its value over long periods of time.

resistance strain gage A strain gage consisting of a small strip of special resistance material that is cemented to the part under test, and changes in resistance with elongation.

resistance thermometer A thermometer based on the variation in the resistivity of platinum or some other metal with temperature.

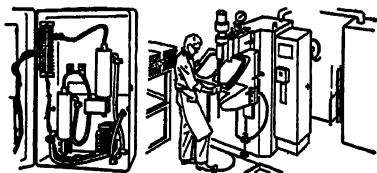

Resistance-welding control using electron tubes.

resistance welding A broad term covering fusion of two metal objects by means of spot, seam, pulsation spot, projection, butt, or flash welding. The two pieces to be welded must be held in close contact under pressure. A definite amount of current, seldom less than 1,000 amperes and often as high as several hundred thousand

amperes, is passed through the joint for a definite period of time, which is generally controlled by electronic equipment, causing the metal at the joint to soften and permit interlocking of grains.

resistance wire Wire made from a metal or alloy having high resistance per unit length, such as Nichrome. Used in wire-wound resistors, heating elements, etc.

resistive conductor A conductor used primarily because it possesses the property of high electric resistance.

resistive coupling The association of one circuit with another by means of resistance that is common to both.

resistivity The resistance in ohms that a unit volume of a material offers to the flow of current. Resistivity is the reciprocal of the conductivity of a material.

resistor A device that offers opposition in the form of resistance to the flow of electric current. The electrical value of a resistor is specified in ohms or in megohms (1 megohm equals 1 million ohms). The power rating in watts of a resistor indicates the amount of power that can safely be dissipated as heat in the resistor.



Color	A 1st digit	B 2d digit	C multiplier	Tolerance code, per cent
Silver.....	0.01	10
Gold.....	0.1	5
Black.....	..	0	0.1	
Brown.....	1	1	10	
Red.....	2	2	100	
Orange.....	3	3	1,000	
Yellow.....	4	4	10,000	
Green.....	5	5	100,000	
Blue.....	6	6	1,000,000	
Purple.....	7	7	10,000,000	
Gray.....	8	8	100,000,000	
White.....	9	9		

Standard RMA color code for molded resistors. For flexible resistors, the body color is A, the three-thread color is B, and the one-thread color is C. With new color arrangement, body color indicates type of resistor: black—composition, noninsulated; tan, olive, or white—composition, insulated; dark brown—wire-wound, insulated. If no gold or silver tolerance band or dot is present, standard tolerance of 20 per cent is assumed.

TEN WAYS OF SPECIFYING
750,000 OHMS

----- 750,000	----- 750 Ma
----- 750,000 ω	----- 750 K ω
----- 750,000a	----- 750 Ka
----- 750 M	----- .75 MEG.
----- 750 M ω	----- .75 MEG. ω

Resistor values may be specified in many ways.

resistor core The insulating support on which a resistor element is wound or otherwise placed.

resistor element That portion of a resistor which possesses the property of electric resistance. It may be pure metal, a metallic coating, a carbon-cement mixture, etc.

resistor furnace A resistance furnace in which the heat is developed in a resistor that is not a part of the charge.

resistor housing The enclosing member that surrounds the resistance element and the core of a resistor.

resolution The sharpness with which two closely adjacent elements of an image can be distinguished.

resolving power A measure of the distinctness with which the images of two point sources of light may be separately detected.

resonance A condition that exists in a circuit containing inductance L and capacitance C when its equivalent (combined) reactance is zero (when $2\pi fL = 1/2\pi fC$). If L and C are in series, the current in the circuit is a maximum at resonance. If L and C are in parallel, the external current supplied to the circuit is approximately a minimum at resonance, and the voltage across the circuit is a maximum. At resonance, a small amplitude of the periodic agency that is maintaining oscillation or vibration in a system produces a relatively large amplitude of oscillation or vibration. Three types of resonance are amplitude

resonance, period resonance, and phase resonance.

resonance bridge A type of alternating-current bridge having in one arm an inductance and capacitance that are adjusted to resonance at the frequency being used.

resonance curve A response curve showing in graphical form the manner in which a resonant circuit or a tuned amplifier circuit responds to the various frequencies in its operating range.

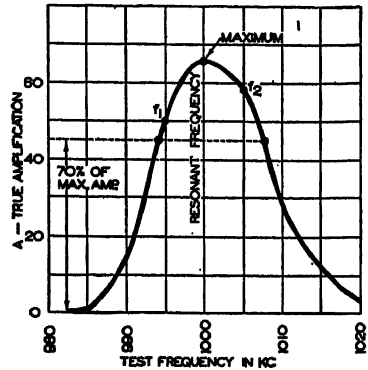

Resonance curve at 1,000 kilocycles for a typical radio-frequency amplifier.

resonance indicator A device that indicates, either visually with a meter or lamp, or audibly in headphones, whether or not a circuit is tuned to resonance.

resonance penetration The penetration of an atomic nucleus by a charged particle whose energy corresponds to one of the energy levels in the nucleus.

resonance radiation Radiation coming from a gas or vapor due to excitation with the resonant frequency of the gas or vapor. An example is sodium vapor irradiated with sodium light.

resonance radiometer A type of thermorelay used for making relative measurements of small radiation intensities in infrared spectrometers.

resonant circuit A circuit containing both inductance and capacitance, and hence capable of exhibiting resonance phenomena.

RESONANT CURRENT STEP-UP

resonant current step-up The ability of a parallel resonant circuit to circulate a current through its inductor and capacitor that is many times greater than the current fed into the circuit.

resonant frequency 1. That frequency, for a given resonant circuit, at which the inductive reactance is equal to the capacitive reactance. **2.** The frequency at which an object will vibrate most readily. Thus, a loudspeaker diaphragm may have one or more resonant frequencies at which it vibrates with a minimum of input energy and hence produces louder sounds than at other frequencies.

resonant frequency of a tube The theoretical highest frequency at which a tube will oscillate, corresponding to complete absence of external capacitance and with circuit inductance reduced to a direct short circuit between the anode and grid terminals. It serves as a figure of merit of a tube as an ultrahigh-frequency generator, but is not a practical rating because the tube output is negligible at this frequency.

resonant line A transmission line having values of distributed inductance and distributed capacitance such as to make the line resonant at the frequency it is handling.

resonant-line oscillator A self-excited ultrahigh-frequency oscillator employing parallel rods as resonant lines in grid and plate circuits.

resonant modes in cylindrical cavities When a metal cylinder is closed by two metal surfaces perpendicular to its axis, a cylindrical cavity is formed. The resonant modes in this cavity are designated by adding a third subscript to indicate the number of half waves along the axis of the cavity. When the cavity is a rectangular parallelepiped, the axis of the cylinder from which the cavity is assumed to be made should be designated since there are three possible cylinders out of which the parallelepiped may be made.

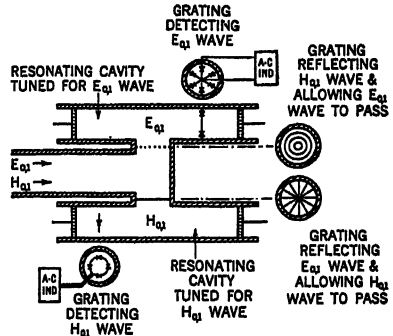

Use of two resonating cavities, each tuned to a different wave, for multiple reception of two waves being propagated simultaneously through a wave guide. A circular reflecting grating (shown in cross-section at upper right) is placed at the entrance to the upper cavity, while a radial wire grating is at the entrance to the lower cavity.

resonant resistance The resistance value to which a resonant circuit is equivalent.

resonant transmission line A resonant line.

resonant voltage step-up The ability of an inductor and a capacitor in a series resonant circuit to deliver a voltage several times greater than the input voltage of the circuit.

resonate To bring to resonance, as by tuning.

resonating cavity A short piece of wave guide of adjustable length, terminated at either or both ends by a metal piston, an iris diaphragm, or some other wave-reflecting device, used as a filter, as a means of coupling between guides of different diameters, and as impedance networks corresponding to those used in radio circuits. The cross-section of the cavity may be circular, rectangular, or any other shape, and long cavities may be coiled or folded.

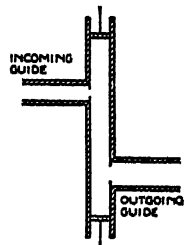

Resonating cavity used as a coupling between incoming and outgoing guides having different diameters.

REST POTENTIAL

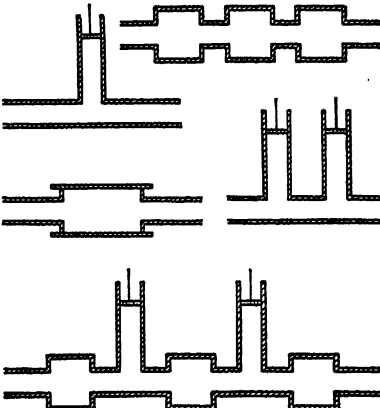

A resonating cavity can be inserted in wave guides to serve as a filter, giving either a sharp or blunt-peaked response as desired.

resonating piezoid A piezoid (finished crystal blank) used as a resonator or oscillator rather than as a transducer.

resonator 1. An apparatus or system in which some physical quantity is capable of being put into a state of oscillation by oscillations in another system. 2. A hollow chamber forming the tuned circuit of an ultrahigh-frequency oscillator. 3. A device for detecting oscillations or electric waves by any method involving resonance.

resonator grid One of the grids attached to cavity resonators in a velocity-modulation tube. The electron beam passes through all the grids.

resonator wavemeter

Any resonant circuit used to determine wavelength, such as a cavity resonator wavemeter.

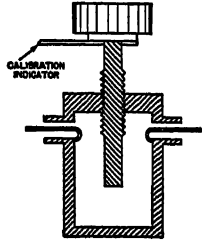

Cross-section view of resonator wavemeter.

respirometer

An instrument for measuring the respiratory rate and the volume and pressure of air during breathing.

response

The output or some other characteristic of an amplifier or device at a particular frequency.

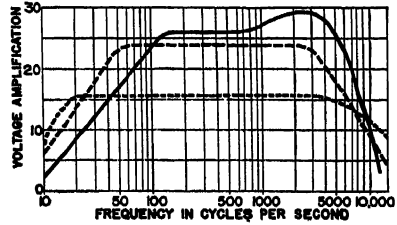

Response characteristics for three different audio-frequency amplifier circuits.

response characteristic

A graph showing the response of a device throughout the range of frequencies normally handled.

rest potential

A residual potential difference remaining between an electrode and an electrolyte after the electrode has become polarized.

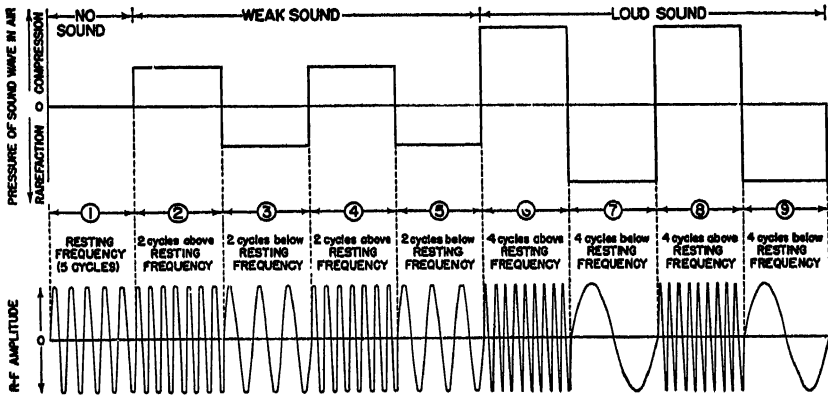

Manner in which the signal frequency of a frequency-modulated transmitter varies above and below the assigned resting frequency.

RESTING FREQUENCY

resting frequency The assigned carrier frequency of a frequency-modulation station. It is radiated only during intervals of silence during programs; at other times, the transmitter frequency swings above and below the resting-frequency value at a rate corresponding to the sound frequency being transmitted. Also called *center frequency*.

restricted radiotelegraph operator permit A commercial operator license issued by the Federal Communications Commission to applicants meeting citizenship and other requirements and passing examinations on basic law, basic theory and practice, radiotelegraph, and transmission and reception of 16 code groups per minute.

restricted radiotelephone operator permit A commercial radio operator license issued by the Federal Communications Commission to applicants meeting citizenship and other requirements and passing examinations on basic law and ability to transmit and receive spoken messages in English.

resuscitation Restoring from unconsciousness due to drowning or electric shock.

retarding-field oscillator An oscillator capable of generating frequencies up to about 5,000 megacycles. It employs a triode tube in which electrons oscillate or vibrate back and forth through the meshes of a grid that is maintained positive with respect to the cathode. The frequency depends on the transit time of the electrons, and this in turn depends on the electrode dimensions and the voltages at which they are operated. Because electrons are negatively charged, the positive grid produces a retarding field that pulls electrons back after they have passed through the grid on their way to the plate, initiating the electron vibration. Barkhausen-Kurz and

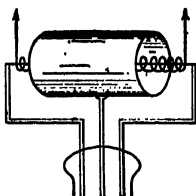

Electrode arrangement in a spiral-grid retarding-field oscillator tube.

Gill-Morrell oscillators are examples. Also called *positive-grid oscillator*.

retardation coil 1. A high-inductance coil used in telephone circuits to permit passage of direct current or low-frequency ringing current while blocking the flow of audio-frequency currents. 2. A closed-secondary coil used to change the phase relation of an alternating magnetic field.

retentivity A measure of the ability of a substance to hold its magnetism. It is the value of the residual magnetic induction (remanence) in a substance undergoing a symmetrical magnetic hysteresis cycle extending from saturation to zero.

retrace The path traced by the electron beam in a cathode-ray tube of a television system in going from the end of one line or field to the start of the next line or field.

retroaction British term for regeneration, involving feedback from the plate circuit to the grid circuit of a vacuum tube or from the output to the input of a vacuum-tube amplifier.

retrograde rays Rays similar to positive rays and magnetically deflected in the same manner but moving away from the cathode instead of toward it.

return wire The ground wire, common wire, or the negative wire of a direct-current circuit.

reverberation A succession of echoes, caused by repeated reflections of sound in a large room or enclosure. Reverberation also occurs under certain conditions in underwater sound transmission and reception.

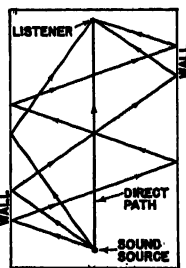

Reverberation paths in a room.

reverberation-controlled gain circuit A circuit used in underwater sound equipment to vary the gain of the receiving amplifier in proportion to the strength of undesired reverberations associated with the desired echo.

RHOMBIC ANTENNA

reverberation time The time in seconds required for the average acoustic energy density in a reverberating enclosure to reduce to one-millionth of its initial steady-state value after the source has been silenced.

reverberation-time meter An electronic instrument for measuring reverberation time directly.

reverse-current relay A relay that operates whenever current flows in the reverse direction.

reversed feedback amplifier An amplifier employing inverse feedback (also called negative or degenerative feedback) to reduce harmonic distortion and otherwise improve fidelity.

reversible motor A motor in which the direction of rotation can be reversed by operating a switch that changes motor connections.

reversible permeability The incremental permeability when the change in magnetic induction is vanishingly small.

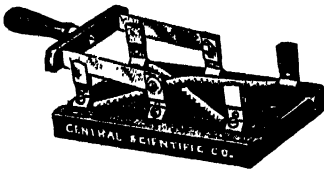

Reversing switch.

reversing switch A switch used to change the direction of rotation of a motor, to change the direction of any form of motion, or to change the polarity of circuit connections.

r-f Abbreviation for radio frequency. Same abbreviation used for noun and adjective.

RFC Designation used on diagrams to identify a radio-frequency choke coil. An iron-core choke coil is generally marked CH.

rheo- A prefix meaning a flowing of current, used in electrical terms that are now practically obsolete, such as rheograph (oscillograph), rheometer (galvanometer), and rheoscope (current indicator). The term rheostat is

the only one of the group still in common use.

rheostat A resistor so constructed that its value may be changed readily by means of a control knob, without opening the circuit in which it is connected. Rheostats having rotating control knobs are used chiefly in radio and industrial equipment, and slide-wire rheostats are used chiefly in laboratory experiments.

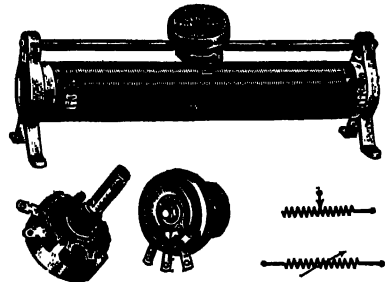

Rheostats and their two equally correct symbols.

rheostatic braking A system of dynamic braking in which the traction motors are used as generators, feeding resistors that dissipate the energy as heat. Also called *resistance braking*.

rheotron The induction electron accelerator originally developed by D. W. Kerst. It speeds electrons just as a cyclotron speeds positive particles. Electrons emitted from the filament of a doughnut-shaped glass vacuum tube are accelerated in gradually contracting orbits by an alternating-current electromagnet and eventually strike a target, producing high-energy photons or X rays. Also called *beta-tron* or *induction accelerator*.

rho Greek letter ρ , frequently used to denote specific resistance.

rhombic antenna A directional antenna array consisting of four long conductors forming the sides of a rhombus (equal-sided parallelogram).

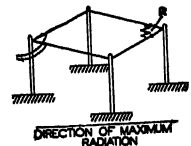

Rhombic antenna.

RHUMBATRON

rhumbatron An evacuated metal enclosure having a carefully designed shape such that electrons passing through the enclosure undergo velocity modulation and act as a resonating system for the generation of extremely high-frequency oscillations. It is thus a resonating chamber in which velocity-modulated electron groups deliver their energy as intensity-modulated beams.

ribbon microphone A moving-conductor microphone in which the moving conductor is in the form of a single flexible ribbon of thin corrugated metal mounted between the poles of permanent magnets. Often called *velocity microphone*.

Rice neutralizing circuit A radio-frequency amplifier circuit that neutralizes the grid-to-plate capacitance of the amplifier tube.

Richardson effect The emission of electrons from hot bodies. The rate of emission increases rapidly with temperature. Also called *Edison effect* or *thermionic emission*.

Richardson equation An expression for the density of thermionic emission at saturation current in terms of the absolute temperature of the filament.

RID Abbreviation for Radio Intelligence Division of the Federal Communications Commission, set up to police the entire radio spectrum and take appropriate action against unlicensed radio stations, as well as monitor licensed stations and intercept foreign broadcasts.

ride gain To control the volume range of a radio program while watching a volume indicator, so that the resulting audio-frequency signal is neither too weak nor too strong for most effective handling by transmission equipment in a radio system.

Righi-Leduc effect Development of a difference in temperature between the two edges of a strip of metal in which heat is flowing longitudinally, when the plane of the strip is perpendicular to magnetic lines of force.

right-handed elliptically polarized wave

An elliptically polarized radio wave in which the rotation of the direction of displacement is clockwise for the observer looking in the direction that the wave is traveling.

right-hand rule 1. For motors and generators: If the thumb, first, and second fingers of the right hand are extended at right angles to one another, with the thumb representing the direction of motion, the first finger representing the direction of the magnetic lines of force, and the second finger representing the direction of the current, the relations between the directions will then be correct for a conductor in the armature of a generator. For a motor, the left hand is used. Also called *Fleming's rule*. 2. For a current-carrying wire: If the fingers of the right hand are placed around the wire in such a way that the thumb points in the direction of current flow, the fingers will be pointing in the direction of the magnetic field. (The above are based on so-called conventional current flow, not electron flow.)

right-hand taper A potentiometer or rheostat having higher resistance in the clockwise half of its rotational range than in its counterclockwise half, looking at the end having the shaft and knob.

rim drive Driving a turntable of a phonograph or sound recorder by means of a small rubber-covered wheel that is on the shaft of an electric motor, and is in contact with the rim of the turntable.

ring The ring-shaped contacting part immediately back of the tip of a telephone-type plug.

ring armature An obsolete armature design consisting of a ring-shaped or tubular iron core wound with wire passing over the surface and through the interior of the core.

ring method A ballistic method of magnetic testing in which a specimen is prepared in the form of a closed ring having a known cross-section, built up from laminations, with a primary coil

and a secondary coil both wound around the ring. A known current through the primary is suddenly reversed, and the resulting induced voltage in the secondary is measured with a ballistic galvanometer connected to the secondary.

ring seal A fused junction between the two halves of a bulb, in the form of a circle of large diameter at or near which the electrode leads emerge from the bulb.

ripple The alternating-current component that is present in the output of a direct-current generator or a power pack.

ripple current The alternating-current component of a pulsating current when this alternating-current component is small with respect to the direct-current component, as in the output of a power pack or direct-current generator.

ripple filter A low-pass filter designed to reduce the ripple current while freely passing the direct current from a rectifier or direct-current generator.

ripple frequency The frequency of the ripple current present in the output of certain direct-voltage sources.

ripple ratio The ratio of the difference between the maximum and minimum values of a ripple quantity to the average value.

ripple voltage The alternating component of the unidirectional voltage in the output of a rectifier or generator used as a source of direct-current power.

rising characteristic A characteristic in which the voltage rises as the current increases, as in an overcompounded generator.

RMA Abbreviation for Radio Manufacturers Association.

RMA color code One of the systems of color markings developed by the Radio Manufacturers Association for specifying electrical values and terminal connections of radio parts. In the resistor color code, colored rings or dots represent definite values.

rms Abbreviation for root mean square.

Robinson-Adcock direction finder The Robinson direction finder.

Robinson direction finder A radio direction finder in which the antenna consists of two coils at right angles, rotatable individually and as a whole. A motor-driven commutator reverses connections to one coil rapidly. Coil positions are adjusted until this reversal has no effect on the strength of the received signal as indicated by a galvanometer; hence bearings can be taken without reducing the received signal to inaudibility.

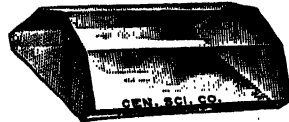

Rochelle-salt crystal.

Rochelle salt crystal A crystal of sodium potassium tartrate, having a pronounced piezoelectric effect, extensively used in crystal microphones and crystal phonograph pickups. Perfect crystals up to four inches in length can be grown artificially.

rocking Back-and-forth rotation of the tuning control in a superheterodyne receiver while adjusting the oscillator padder near the low-frequency end of the tuning dial, to secure more accurate alignment.

Rocky Point effect A sudden increase in the emission of large thermionic vacuum tubes, probably due to irregularities in the cathode surface. Sometimes causes complete breakdown. Also called *flash arc*.

roentgen The international unit of quantity of roentgen rays (X rays). It is the quantity of X-ray radiation that, when the secondary electrons are fully utilized and the wall effect of the chamber is avoided, produces in 1 cubic centimeter of air at 0° centigrade and normal atmospheric pressure such a degree of conductivity that one electrostatic unit of charge is measured at saturation current.

ROENTGENIZATION

roentgenization Discoloration of glass after prolonged irradiation with X rays.

roentgen machine Medical term for an X-ray machine.

roentgen meter An instrument for measuring the quantity or intensity of roentgen rays (X rays) or gamma rays. Also called *ionometer* or *roentgenometer*.

roentgenogram A photographic record of the relative transparency of the various parts of an object to roentgen rays (X rays). Also called *radiograph* or *X-ray photograph*.

roentgenography The art of producing roentgenograms (X-ray photographs).

roentgenology That branch of science which deals with X rays, especially their use for diagnosis or treatment in medicine and dentistry. Radiology is a slightly more general term covering also radioactivity and other extremely high-frequency radiation.

roentgenometer An instrument for measuring the quantity or intensity of roentgen rays (X rays). Also called *ionometer* or *roentgen meter*.

roentgenoscope A device consisting of a fluorescent screen mounted either separately or in conjunction with an X-ray tube. The shadows of objects interposed between the tube and the screen are made visible on the screen by the X-ray radiation. Also called *fluoroscope*.

roentgenoscopy The use, in diagnosis, testing, etc., of a fluorescent screen that is activated by roentgen rays (X rays). Also called *fluoroscopy*.

roentgenotherapy The treatment of disease by roentgen rays (X rays).

roentgen ray An X ray, which is a penetrating electromagnetic radiation similar to light but having much shorter wavelengths (from about 10^{-7} to 10^{-10} centimeter). Usually generated by allowing a stream of high-speed electrons to strike a metal target. The resulting bombardment of the atoms in the target causes the atoms to lose energy, and this energy is radiated as X rays of definite wavelength. The

term roentgen ray is preferred by medical authorities, while the term X ray is in more general use.

Roget spiral A helix of wire that contracts in length when a current is sent through, owing to mutual attraction between adjacent turns.

root-mean-square value The effective value of an alternating current, corresponding to the direct-current value that will produce the same heating effect. Unless otherwise specified, alternating quantities are assumed to be root-mean-square values.

rosin-core solder Solder made up in tubular or other hollow form, with the inner space containing the correct amount of rosin flux for effective soldering of electrical joints.

rotary beam antenna

A highly directional short-wave antenna system mounted on a mast in such a manner that it can be rotated to any desired position either manually or by an electric motor drive.



Rotary beam antenna.

rotary capacitor A name sometimes applied to a synchronous motor operated to draw a leading current like that of a capacitor in order to improve power factor.

rotary converter A rotating electric machine having a single armature containing both a commutator and slip rings. If driven by a motor or engine, both alternating-current and direct-current power may be obtained from it simultaneously. If alternating-current power is fed into the slip rings, the converter rotates as a motor and

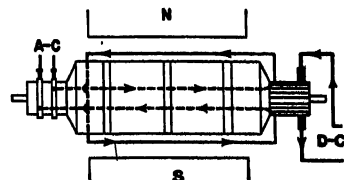

Rotary converter circuit.

delivers direct-current power to the commutator as a generator.

rotary field A magnetic field that can be represented by a rotating magnetic-intensity vector, as the field of an induction motor.

rotary gap A rotary spark gap.

rotary spark gap A type of spark gap used at one time in radio transmitters, in which the sparks occurred between one or more fixed electrodes and a number of studs on a rotating disk.



Rotary jack switch (left) and ordinary rotary switch.

rotary switch A switch operated by rotating its shaft.

rotary synchroscope An instrument having two windings, one connected to an alternating-current power line and the other connected to an alternator that is to be synchronized with the power line. The pointer of the instrument rotates slowly in one direction if the incoming machine is too fast, and in the other direction if too slow. When the pointer is stationary, synchronism exists and switching may be performed.

rotary transformer A term sometimes applied to a rotating machine used to transform direct-current power from one voltage to another.

rotary voltmeter A type of electrostatic voltmeter used for measuring high voltages.

rotatable transformer A motorlike device having a single-phase salient-pole rotor and a two-phase two-pole high-impedance stator winding. At constant rotational speed (1,800 revolutions per minute in one model), the voltage output can be varied from

zero to a maximum value that is 1.72 times the voltage applied to the rotor, by shifting the position of the rotor relative to the stator.

rotating direction finder A direction finder in which the loop antenna is rotated for the purpose of taking bearings.

rotating field A vector field in which the vector at each point rotates in a plane, the planes of rotation being parallel. All vectors in one plane must be in phase, but there may be a change in phase from one plane to another. The rotating magnetic field of an induction motor is an example.

rotating-loop radio transmitter A type of rotating radio beacon from which aircraft can determine their bearings by the time elapsed between reception of a nondirectional signal coinciding with the north position of the beam and the directional signal of the rotating beam itself.

rotating radio beacon A radio transmitter arranged to radiate a concentrated beam that rotates in a horizontal plane at constant speed and transmits different signals in different directions so that ships and aircraft can determine their bearings without the use of directional receiving equipment.

rotational quantum number A quantum number that determines the total angular momentum of a molecule exclusive of nuclear spin. It is denoted by J when it includes electron spin, and by K when it is exclusive of electron spin.

rotation diagram The photographic record of diffracted beams produced when a slender beam of X rays is directed on a rotating single crystal. A special type of Laue pattern.

rotation spectrum An X-ray spectrum or diffraction pattern obtained when an X ray is sent through a rotating crystal.

rotor The rotating member of a machine or device, such as the rotating armature of a motor or generator, or the rotating plates of a variable capacitor

ROTOR PLATES

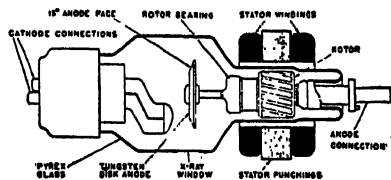

Rotating-anode X-ray tube, with the anode mounted on the rotor shaft and the stator or field windings of the induction motor located outside the neck of the tube, separated from the rotor by glass. Rotation of the anode prevents excessive heating at the focal spot.

rotor plates The rotating plates of a variable capacitor, usually directly connected to the metal frame.

Rowland ring A sample of magnetic material, prepared in the form of a ring in order to test its magnetic properties during use as the core of a transformer.

rpm Abbreviation for revolutions per minute.

rps Abbreviations for revolutions per second.

rubidium A photosensitive metal sometimes used on the cathode of a phototube when maximum response is desired to blue-green light.

Ruhmkorff coil An induction coil having a magnetic interrupter. Used to produce a spark discharge across an air gap.

rumble A low-frequency vibration originating in the driving motor of a turntable and mechanically transmitted to the recording or reproducing turntable, so that it is heard in the reproduced sounds.

Rumford photometer A type of photometer in which the shadows cast by a standard light source and the light source under test are compared and brought to equality by varying the relative distances of the sources from the screen. Also called *shadow photometer*.

Rumpf The highly stable electron group that remains when a chemically active atom is ionized by the removal of its incomplete outer shell of electrons. Also called *core* or *kernel*.

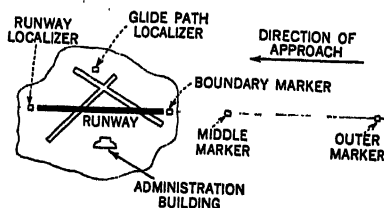

Position of runway localizing beacon and glide path localizer with relation to landing strip designated for instrument landings (shown in solid black) at a typical airport.

runway localizing beacon A small radio-range beacon used to provide accurate directional guidance along the runway of an airport and for some distance beyond.

Rutherford-Bohr atom The atom as conceived by Bohr and Rutherford, consisting of a positive nucleus about which circulates a number of orbital electrons. Also called *Bohr atom*.

Rutherford scattering law A classical expression for the effective cross-section about the nucleus of an atom, which an alpha particle must enter in order to be scattered into a definite solid angle.

S

S Generally used on circuit diagrams for denoting the secondary winding of a transformer.

sabin In acoustics, a unit of equivalent absorption, equal in its absorbing effect to 1 square foot of a completely absorbing surface.

Sabine's law The reverberation time of a room is $T = 0.164V/aS$, in which V is the volume of the room in cubic meters, S is the total area of its exposed surfaces in square meters, and a is the mean acoustic absorptivity of the surfaces for vocal sounds.

SAE Abbreviation for Society of Automotive Engineers.

Safety Convention The International Convention for the Safety of Life at Sea and the regulations referred to therein.

safety factor The amount of load, above the normal operating rating, that a device can handle without failure.

Saint Elm's fire A visible electric discharge sometimes seen on the mast of a ship or on any metal point when there is a considerable atmospheric difference of potential. It is due to concentration of the electric field at the points of the conductors.

sal ammoniac Ammonium chloride.

sal ammoniac cell A cell in which the electrolyte consists primarily of a solution of ammonium chloride.

salient pole A pole consisting of a separate radial projection having its own iron pole piece and its own field coil, used in the field system of a generator or motor.

salient-pole generator A generator having salient poles, particularly when these poles serve as the rotating field in a large turbo-alternator.

sapphire A pure variety of corundum occurring in nature and also produced artificially, used for tips of phonograph needles and for the cutting or embossing stylus in the cutting head of a sound recorder.

Saran A thermoplastic material having good insulating qualities, used for pipes and fittings in electrical equipment requiring a cooling water supply which is insulated from ground. Also used in sheets and other forms.

saturation Maximum possible magnetization of a magnetic substance, maximum possible vapor pressure of some substance in a given space, or maximum concentration of a solution at a definite temperature.

saturation current The maximum possible ionization current, thermionic current, or photoelectric current that can be obtained as voltage is increased in an electronic tube. It occurs when ions or electrons are being carried off as fast as they are released by collision, heat, or light.

saturation curve A magnetization curve for a ferromagnetic material.

saturation induction The maximum possible magnetic induction for a given material.

saturation value 1. The highest value that can be obtained under given conditions. 2. The value of magnetic flux density beyond which increases in magnetizing force have no appreciable effect on flux density in a particular sample of magnetic material.

saw-tooth generator A vacuum-tube oscillator providing an alternating voltage having a saw-tooth waveform.

saw-tooth voltage A voltage that varies linearly at regular intervals between two values, usually with the voltage

SCALAR FIELD

dropping faster than it rises, so that the waveform pattern of the voltage resembles the teeth of a saw.

scalar field The totality of values of some scalar quantity that has a definite value at each point in a given region of space. Thus, the distribution of the magnetic potential in a region surrounding a conductor carrying an electric current is a multiple-value scalar field.

scalar function A scalar quantity that has one or more definite values for every value, within assigned limits, of a variable scalar quantity. Thus, the resistance of a given conductor is a scalar function of the temperature of the conductor.

scalar potential field For a noncircuital vector field, the scalar potential field is a scalar field such that the negative of the gradient at each point is the value of the vector field at that point.

scalar quantity Any quantity that has only magnitude, such as resistance, time, or temperature.

scale length The length of the path described by the end of the pointer of an indicating instrument (meter) in moving from one end of the scale to the other.

scale of eight A vacuum-tube circuit for counting pulses, in groups of eight, obtained from ion or photon counters.

scale-of-two circuit A two-tube circuit that produces one output pulse for each two input pulses. Also called *scaling couple*.

scaling An electronic method of counting electrical pulses occurring faster than can be handled by mechanical recorders.

scaling circuit An electronic circuit used in connection with a mechanical recorder to count pulses at higher rates than can be handled by the recorder alone. The circuit trips the recorder for every second, every fourth, or every n th pulse. The recorder indication must then be multiplied by the scaling ratio of the circuit to obtain the correct

number of pulses. Used for counting pulses due to cosmic rays or radioactivity.

scaling couple A two-tube circuit that produces one output pulse for each two input pulses. Also called *scale-of-two circuit*.

scaling ratio The ratio of the number of pulses entering a scaling circuit to the number of times the mechanical recorder is tripped.

scan To examine point by point, as in converting a scene or image into a methodical sequence of elemental areas.

scanner That part of a facsimile transmitter which systematically translates the densities of the elemental areas of the subject copy into signal-wave form. It generally includes a light source, an optical system that permits isolating an elemental area of the subject copy, means for systematically moving with respect to each other the subject copy and part or all of the scanner, and a light-sensitive device with its directly associated circuits.

scanner amplifier A vacuum-tube amplifier used to amplify the output signal voltage of the scanner in a facsimile transmitter.

scanning 1. The process of successively analyzing, according to a predetermined method, the light values of picture elements constituting the total picture area in a television or facsimile system, or reproducing the corresponding elements at the receiving end. 2.

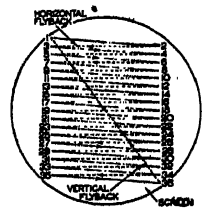

Normal scanning, without interlacing, showing the path taken by the electron beam on the fluorescent screen of a television cathode-ray tube.

Movement of a device through all its possible positions, as in tuning a receiver from one end to the other of its tuning range.

scanning disk A carefully balanced rotating metal disk having one or more

spirals of holes near the circumference, used to break up a scene into elemental areas at a television camera or to reconstruct a scene in a television receiver of a mechanical television system. The holes in the disk sometimes contain lenses.

scanning head A light source and phototube combined as a single unit for scanning a moving strip of paper, cloth, or metal in photoelectric side-register control systems.

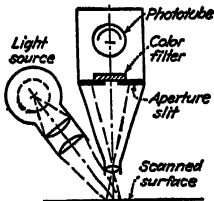

Scanning head used in photoelectric register control systems.

scanning line A single continuous narrow strip that is determined by the process of scanning.

scanning spot The area viewed at any one instant by the pickup system of a facsimile scanner or television camera.

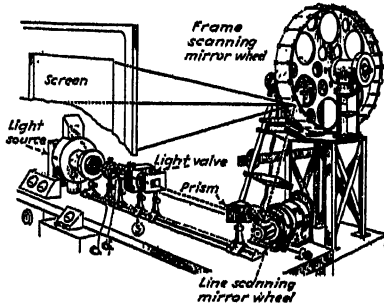

Mirror wheel scanning system.

scanning yoke The specially shaped iron core that supports the electromagnetic deflecting coils which surround the neck of some types of cathode-ray tubes to provide controlled deflection of the electron beam.

scattered reflections Reflections from a region of the ionosphere, involving components having different vertical heights and that interfere with each other to cause rapid fading.

scattered roentgen rays Roentgen rays (X rays) that, during their passage through a substance, have been deviated in direction and may also have been increased in wavelength.

scattering factor The ratio of the actual intensity of X rays scattered in any direction by electrons to that which would exist if the electrons acted independently in accordance with the classical theory of J. J. Thomson. Sometimes called *S value*.

sec wire Abbreviation for single-cotton-covered wire.

see wire Abbreviation for single cotton over enamel insulation on a wire.

schematic circuit diagram A circuit diagram in which component parts are represented by simple, easily drawn schematic symbols.

Schering bridge An alternating-current form of Wheatstone bridge, used for comparing capacitances or for measuring the phase angle of a capacitor by comparison with a standard capacitor. The other two arms of the bridge contain a variable resistance and a resistance shunted by a variable capacitance.

Schottky effect An expression for the saturation current in a thermionic vacuum tube: $I = 1.01 \sqrt{E/T}$ in which E is the electric intensity at the cathode and T is the absolute temperature of the cathode. Sometimes called *shot effect*.

Schrodinger equation A wave equation set up by Schrodinger to represent the de Broglie wave. It gives the relation between the wave function, the particle mass, the total energy, the potential energy, and Planck's constant.

Schuler tube A vacuum tube having a hollow cathode, used for the production of ionized gas or vapor spectra.

Schumann region A range of very short ultraviolet wavelengths, extending down to about 1,200 Angstrom units.

scintillation A minute flash of light, such as that observed when an alpha

SCOPHONY TELEVISION SYSTEM

particle strikes a suitable luminescent screen in the dark.

Scophony television system A mechanical television system developed in England, utilizing the light-storage phenomenon of a supersonic light valve and ingenious optical and mechanical methods that provide large bright images suitable for theater installations as well as for home television receivers. The apparent screen brightness is multiplied several hundred times because several hundred picture elements are projected simultaneously.

Scott connection A method of connecting transformers to convert two-phase power to three-phase power, or vice versa.

scp Abbreviation for spherical candle-power.

scrambled speech Speech that has been made unintelligible by inverting the frequencies in such a manner as to change the sound completely for secret transmission of transoceanic radio-telephone calls and other purposes yet permit converting it back at the receiving end. Also called *inverted speech*.

scrambler circuit A circuit that divides essential speech frequencies into several ranges by means of filters, and displaces the frequencies in each range a given amount so that the resulting reproduced sounds are unintelligible when the signal is picked up by an ordinary radio receiver. Used to obtain secrecy in radiotelephony. The process is reversed at the receiving apparatus to form intelligible speech.

scratch filter A low-pass filter circuit inserted in the circuit of a phonograph pickup to suppress higher audio frequencies and thereby suppress needle-scratch noises.

screen 1. A metal partition or shield used to isolate a device or apparatus from the undesired effects of external magnetic or electric fields. 2. The screen grid electrode of an electron tube. 3. The chemically treated or coated surface on the inside of the large

end of a cathode-ray tube. It becomes luminous where the electron beam of the tube impinges on it.

screen grid A grid placed between the control grid and plate of an electron tube and usually maintained at a fixed positive potential with respect to the cathode for the purpose of reducing the electrostatic influence of the anode in the space between the screen grid and the cathode.

screen-grid tube A vacuum tube having a grid between the cathode and plate. It serves to prevent variations in plate voltage from affecting the grid-filament circuit and causing feedback.

screen-grid voltage The direct voltage value applied between the screen grid and the cathode of a vacuum tube.

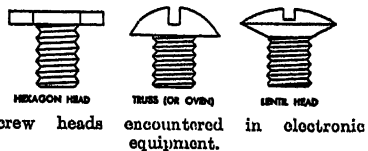
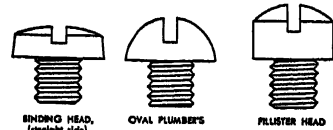

script The manuscript from which spoken portions of a radio program are read during broadcasting.

script writer The person who writes the dialogue for a radio program.

Se Chemical symbol for selenium.

seadrome light A light mounted on a doughnut-shaped rubber buoy and used to outline a landing lane on water at night for seaplanes. One type uses a hot-cathode fluorescent lamp operating from a 45-volt dry battery, with

SECONDARY STATION

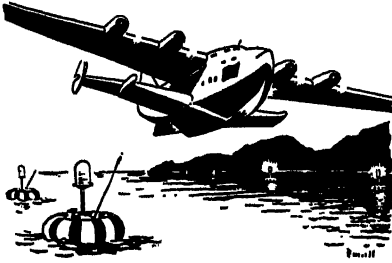

Seadrome light with radio on-off controls.

a radio receiver to turn the light on and off in response to signals transmitted by a shore radio station.

sealing compound Any type of wax used in dry batteries, capacitor blocks, transformers, etc., to keep out air and moisture.

sealing off Final closing of the bulb of a vacuum tube or lamp after evacuation. At a point as close to the bulb as possible, the glass tubing that connected the bulb to the vacuum pump is heated with a torch until it melts and collapses, sealing off the bulb and at the same time removing it from the vacuum system.

seam welding A resistance welding process in which overlapping or tangent spot welds are made progressively.

search coil An exploring coil of wire used with a ballistic galvanometer or fluxmeter to measure flux density in a magnetic field.

sec 1. Abbreviation for second. 2. Abbreviation for the secondary winding of a transformer. 3. Abbreviation for secant.

secohm Former name for the practical unit of inductance, now called the henry.

secondary That transformer winding which receives energy by electromagnetic induction from the primary. The primary receives its energy from the supply circuit. A transformer may have several secondary windings.

secondary battery A connected group of two or more storage cells. Common usage permits application of this term

to a single cell used independently. Also called *storage battery*. Corresponding British term is *accumulator*.

secondary cell An electrolytic cell for the generation of electric energy, in which the cell after being discharged may be restored to a charged condition by an electric current sent through the cell in a direction opposite that of the discharging current. Also called *storage cell*.

secondary electron An electron emitted as a result of bombardment of a material with electrons or cathode rays. Also, that electron which has the less energy after a collision between two electrons; the other is the primary electron.

secondary-electron multiplier An electron tube in which the electron stream is focused in turn onto a succession of targets, each of which adds its secondary electrons to the stream, thus providing considerable amplifying effect.

secondary emission Electron emission due directly to the impact of electrons or ions.

secondary radiation Reradiation of electromagnetic waves in a random manner.

secondary roentgen rays Roentgen rays (X rays) emitted by any matter that has been irradiated with X rays.

secondary service area The area served by the sky wave of a broadcast station and not subject to objectionable interference. The signal is subject to intermittent variations in intensity.

secondary standard 1. A unit, as of length, capacitance, or weight, used as a standard of comparison in individual countries or localities, but checked against the one primary standard in existence somewhere. 2. A unit defined as a specified multiple or sub-multiple of a primary standard, such as the centimeter.

secondary station Any standard broadcast station except a class I station operating on a clear channel.

SECONDARY VOLTAGE

secondary voltage The voltage across the secondary winding of a transformer.

secondary winding One of the output windings on a transformer. It may provide either higher or lower alternating voltage than the primary winding, depending on the ratio of turns between primary and secondary windings.

secondary X rays X rays given off by an object irradiated with X rays. The frequency of the secondary rays is characteristic of the material in the object.

second detector In a superheterodyne receiver, the stage that separates the intelligence signal from the intermediate-frequency carrier signal.

secular variation The slow variation in the strength of the magnetic field of the earth, requiring many years for a complete cycle.

Seebeck effect Development of a voltage due to differences in temperature between two junctions of dissimilar metals in the same circuit. Discovered by J. T. Seebeck, German physicist, in 1821. Also called *thermo-electric effect*.

seismophone A special type of microphone placed in contact with the ground to detect sounds coming through the ground.

seismograph An instrument for recording the time, direction, and intensity of earthquakes or earth shocks produced by explosions during geophysical prospecting.

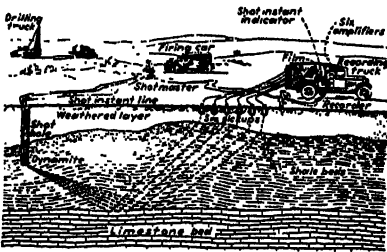

Seismic prospecting for petroleum with seismographs and associated geophysical equipment.

selectance See *selectivity*.

selective Possessing the ability to respond to a desired frequency in greater degree than to other frequencies.

selective absorption Absorption of rays having only a certain group of frequencies.

selective fading Fading in which there are rapid variations in field strength of all frequencies within a particular band, along with independent variations of different frequencies or very narrow bands of frequencies that do not fade in unison.

selective interference Radio interference whose energy is concentrated in a narrow band of frequencies. It can be produced by other radio stations, by harmonics of other stations, by unshielded diathermy equipment, etc.

selective network A transducer (energy-transferring device) that, when inserted in a circuit for which it is designed, causes in this circuit an insertion loss, a phase shift, or both, varying with frequency in some desired way.

selective radiation Radiation of rays having only a limited range of frequencies.

selective receiver A radio receiver that responds only to the frequency to which it is set.

selective reflection Reflection of rays having only a certain group of frequencies.

selective ringing A telephone arrangement in which only the bell of the called subscriber rings, with other bells on the party line remaining silent.

selectivity The degree of falling off in the response of a resonant device with departure from resonance. It can be expressed as the ratio of the amplitude of response at the resonant frequency to the response at some frequency differing from it by a specified amount. It determines the ability of a radio receiver to reject undesired signals. Also called *selectance*.

selectivity control A control that adjusts the selectivity of a radio receiver. In a superheterodyne receiver, it usually adjusts the coupling between the windings in one or more intermediate-frequency transformers.

selector 1. An automatic or other device for making connections to any one of a number of circuits at will. 2. An automatically actuated multiple-contact device that makes contact with any desired circuit by electromagnetic means. It may be controlled by a step-by-step method utilizing varying numbers of current impulses, or may be used to find an idle line by hunting over a number of contacts and stopping at one having the required conditions to bring action of a relay.

selector switch A selector.

selenium A chemical element having marked photosensitive properties. Its resistance varies inversely with illumination. Used in photoconductive cells and in some types of photovoltaic cells, as well as in some dry-disk rectifiers.

selenium amplifier An apparatus used to increase the strength of signals received from a submarine cable. The signals are fed to a mirror galvanometer, and the resulting movements of the mirror cause a light beam to move over two selenium cells in opposite arms of a Wheatstone bridge, changing the relative resistances of the two cells and unbalancing the bridge.

selenium cell A photoconductive cell consisting of a small amount of selenium between suitable electrodes. The resistance of the cell decreases when the amount of illumination on the cell is increased.

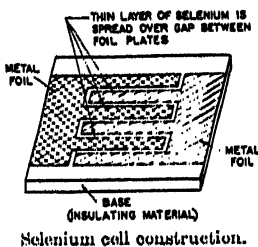

selenium relay A type of relay in which the weak actuating current is sent through a lamp that changes the illumination of a selenium cell, thereby causing much greater current variations.

self-bias Production of grid bias voltage by a vacuum tube itself, by the flow of plate and other electrode currents through a resistor in the cathode lead. The resulting voltage drop across this resistor serves as the grid bias, thereby eliminating the need for a separate C bias voltage source. Also called *automatic grid bias*.

self-capacitance The distributed capacitance of a circuit or coil containing closely spaced insulated wire, due to the capacitor effects between adjacent conductors.

self-cleaning contacts Contacts so designed that they close with a rubbing motion that keeps them clean.

self-excitation Supplying field current to a generator from its own armature.

self-excited oscillator A vacuum-tube oscillator that starts up and continues operation without external excitation other than the direct voltages applied to the electrodes. Application of the direct voltage causes surges in the resonant circuits sufficient to initiate oscillation.

self-healing capacitor A capacitor that repairs itself after breakdown due to excessive voltage. Air dielectric capacitors and some wet electrolytic capacitors have this characteristic.

self-impedance At any pair of terminals of a network, the ratio of an applied voltage to the resultant current, all other terminals of the network being open.

self-inductance That property of an electric circuit which determines, for a given rate of change of current in the circuit, the electromotive force induced in the same circuit.

self-induction The production of a voltage in a circuit by a varying current in that same circuit.

SELF-LOCKING NUT

self-locking nut

Any of various types of nuts having an inherent locking action, so that they are not readily loosened by vibration.

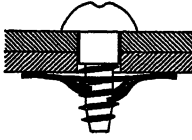

Self-locking spring-steel nut, used here with a self-tapping screw.

self-quenched de-

detector A superregenerative detector in which the time constant of the grid leak and grid capacitor is sufficiently large to cause intermittent oscillation above audio frequencies, serving to stop normal regeneration each time just before it spills over into a squealing condition.

self-reset Automatically returning to the original position when normal conditions are resumed. Applied chiefly to relays and circuit breakers.

self-starting synchronous motor A synchronous motor provided with the equivalent of a squirrel-cage winding, so that it can be started as an induction motor.

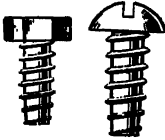

Self-tapping screws.

self-wiping contacts Contacts that close with a sliding motion which automatically wipes off dirt.

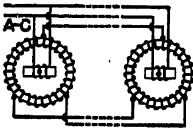

Selsyn-motor circuit for single-phase a-c line.

selsyn A General Electric Company trade name, derived from self-synchronous. It is equivalent to such other trade names as Autosyn, mag-slip, motor-torque generator, and Siemens, all of which are equivalent to the universal term synchro.

selsyn generator One name for the transmitter of a synchro unit. It is a larger and higher wattage unit than

the indicator, and its rotor is geared to or otherwise linked with some sort of mechanical equipment.

selsyn motor A synchro-motor (specially designed synchronous motor) having a rotor that will always assume exactly the same position as the rotor of a synchro-generator to which it is connected, even though the two units are some distance apart. The rotors thus will always run at equal speeds and reverse at the same instant. Used chiefly for obtaining a remote indication of position or for remote control.

selsyn system Trade name for a system obtaining remote indication or control by means of self-synchronizing selsyn motors. The general term is *synchro system*.

semiabsolute volt The voltage drop across one international ohm when one absolute or true ampere is flowing through the resistance. Sometimes used in specifying the voltage of a standard cell. The Weston cell at 20° centigrade is 1.08121 semiabsolute volts.

semiautomatic substation A power substation in which the sequence of starting operations is automatic but is put into action by remote control from some other point.

semiautomatic telephone system A telephone system in which operators receive numbers from subscribers verbally but use automatic apparatus to obtain the required connections.

sending Transmitting, as Morse code.

sending-end impedance The ratio of an applied voltage to the resultant current at the point where the voltage is applied. For a line, it is the same as the driving-point impedance of the line, and for an infinite uniform line these are the same as the characteristic impedance.

sense finder That portion of a radio direction finder which determines from which of two opposite directions a radio wave is arriving.

sensitive relay A relay requiring only small currents for its operation (ordinarily less than 10 milliamperes). Used extensively in photoelectric circuits.

sensitivity 1. That characteristic of a radio receiver which determines the minimum strength of signal input capable of causing a desired value of signal output. 2. The change in the reading of a measuring instrument per unit of measured quantity. Sometimes called sensibility or sensitiveness. 3. The displacement of the luminous spot on the screen of a cathode-ray tube per volt applied to the deflecting plates or per ampere of current through a deflecting coil.

sensitivity control A control that adjusts the amplification of radio-frequency amplifier stages in a radio receiver.

separate excitation Providing field current for a generator from an independent source, or for a motor from a source different from that connected across the armature.

separator An insulating sheet or other device employed in a storage battery to prevent metallic contact between plates of opposite polarity within a cell.

septate coaxial cavity A coaxial cavity having a vane or septum added between the inner and outer conductors, so that it acts essentially like a cavity of rectangular cross-section bent transversely. It is characterized by sharp-peaked resonance and low energy losses.

septum A thin metal vane perforated with an appropriate wave pattern and inserted in a wave guide for wave reflecting or other purposes.

series 1. The indicated sum of a set of terms in a mathematical expression, as in an alternating series or an arithmetic series. 2. A method of arranging the parts in a circuit by connecting them end to end to provide a single path for current.

series circuit A circuit in which all parts are connected in series (end to end) to provide a single path for current.

series coil The coil that carries the main current in a rotating machine or other device. The shunt coil is connected across the line and carries only a small current.

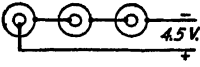
series connection  A connection in which the same current flows in turn through all the parts in the circuit.
Series connections of dry cells.

series excitation Obtaining field excitation in a motor or generator by allowing the armature current to flow through the field winding.

series feed Application of direct voltage to the plate of a vacuum tube through the plate load that is carrying the signal current. In shunt feed, the direct voltage is applied to the plate through a choke, and only signal current flows through the load.

series field 1. That part of the total magnetic flux in a machine which is due to the series winding. 2. The coil that produces the series field.

series loading Loading in which reactances are inserted in series with the conductors.

series modulation Modulation in which the modulating tube, the modulated amplifier tube, and the plate voltage supply are all in series.

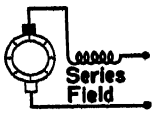
series motor A commutator-type motor having armature and field windings in series. Characteristics are high starting torque, variation of speed with load, and dangerously high speed on no-load.

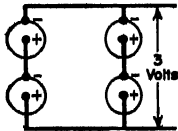
Series motor.

series-parallel switch A switch used to change the connections of lamps or other devices from series to parallel, or vice versa.

Series-parallel connections of dry cells.

series resonance The steady-state condition that exists in a circuit comprising

SERIES RESONANT CIRCUIT

inductance and capacitance in series when the current in the circuit is in phase with the voltage across the circuit.

series resonant circuit An inductor and capacitor in series, having electrical values such that the inductive reactance of the inductor is equal to the capacitive reactance of the capacitor at the frequency being handled. At this condition, corresponding to resonance, the circuit current is a maximum and the voltage across either the inductor or the capacitor may be several times the voltage applied to the combination.

series wound In a motor or generator, having windings so designed that the armature and field windings are in series.

serrated pulse A vertical or horizontal synchronizing pulse divided into a number of small pulses each of which acts for the duration of half a line in a television system.

serrated rotor plate A rotor plate having radial slots to permit bending different sections of the plate either inward or outward to adjust the total capacitance of a variable capacitor section during alignment. Also called *slotted rotor plate*.

service area That area surrounding a broadcast station in which the signal is strong enough for satisfactory reception at all times, and not subject to objectionable interference or fading. The primary service area of a broadcast station means the area in which the ground wave is not subject to objectionable interference or fading. The secondary service area means the area served by the sky wave and not subject to objectionable interference. The signal is subject to intermittent variations in intensity. The intermittent service area means the area receiving service from the ground wave but beyond the primary service area and subject to some interference and fading.

service band A band of frequencies allocated to a given class of radio service.

service life The length of time required for a primary cell or battery to reach a specified final electrical condition on a service test representative of normal usage.

service oscillator A test instrument that can be used to generate the various radio-frequency voltages required for alignment and servicing of radio equipment. Usually called *radio-frequency signal generator*.

servo-motor A special electric, hydraulic, or other type of motor that can be used as a mechanical relay to convert a small movement into one of greater amplitude or greater force. Used in control apparatus.

set analyzer A test instrument designed to permit convenient measurement of voltages and currents in a radio receiver for servicing purposes.

setscrew A small machine screw, usually with a recessed hexagonal socket or a slot but having no head, used to hold control knobs on shafts, to hold playing needles in phonograph pick-ups, to hold the cutting stylus in a cutting head, and for similar purposes.

SG Generally used to denote the screen grid electrode of a vacuum tube.

shade A device used to diminish or intercept the light from a lamp in certain directions where such light is not desirable. Often used on photoelectric light sources.

shaded-pole motor A single-phase induction motor having one or more auxiliary short-circuited windings acting on only a portion of the magnetic circuit.

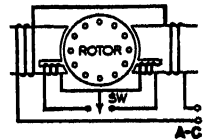

Shaded-pole induction-motor circuit (reversible).

Generally the winding is a closed copper ring imbedded in the face of a pole. The shaded pole provides the required rotating field for starting purposes.

shading ring 1. A heavy copper ring sometimes placed around the central pole piece of an electrodynamic loud-

SHEET GRATING

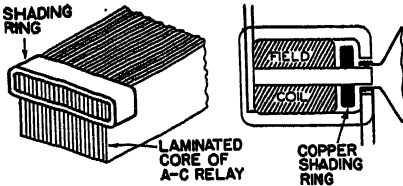

Shading ring as used on the core of an a-c relay to prevent chatter, and on an electrodynamic loudspeaker to reduce hum.

speaker to serve as a shorted turn that cancels hum voltage of the field coil.

2. The copper ring that is set into part of a pole piece on small alternating-current motors to produce a rotating magnetic field for starting purposes.

shading signal In a television camera, the signal that serves to increase the gain of the amplifier in the camera during those intervals of time when the electron beam is on an area corresponding to a dark portion of the scene being televised.

shadow attenuation The attenuation of radio waves over a sphere in excess of that over a plane when the distance over the surface and other factors are the same.

shadowgraphing A process of inspecting phonograph needles and other small objects by producing a greatly enlarged image or shadow on a viewing screen on which permissible variations in shape are marked for comparison.

shadowgraph tuning indicator A shadow tuning indicator.

shadow photometer A type of photometer in which the shadows cast by a standard light source and the light source under test are compared and brought to equality by varying the relative distances of the sources from the screen. Also called *Ramford photometer*.

shadow tuning indicator A device that indicates when a radio receiver is accurately tuned to a station by the narrowing of a shadow thrown on a glass screen by the vane-shaped pointer of a meter movement. The meter is actuated by some circuit current, usu-

ally in or near the second detector, that is proportional to signal strength.

shank That part of a phonograph needle which is clamped into position by a setscrew in the pickup or cutting head.

shape factor The form factor, a value that takes the shape of a coil into account when computing its inductance.

shaping network An electrical network designed to be inserted in a circuit to improve its transmission properties, impedance properties, or both. Also called *corrective network*.

sharp tuning Responsive to a limited range of frequencies.

shearer tube An X-ray tube having a metal envelope and porcelain insulation around electrode leads.

sheath 1. The external conducting surface of a shielded transmission line. 2. The metal wall of a wave guide. 3. A part of a discharge in a rarefied gas in which there is a space charge due to an accumulation of electrons or ions.

sheath-reshaping converter A wave converter in which the change of wave pattern is achieved by gradual reshaping of the sheath of the wave guide and of conducting metal sheets mounted longitudinally in the guide.

sheet grating A three-dimensional grating consisting of thin longitudinal metal sheets extending along the inside of a wave guide for a distance of about a wavelength, and used to stop all waves except one predetermined wave that passes unimpeded. A sheet grating is thus a highly effective wave filter. Examples are radial planes through the center of a circular guide, passing *H* waves of zero order, and a family of hollow coaxial cylinders, passing *E* waves of zero order.

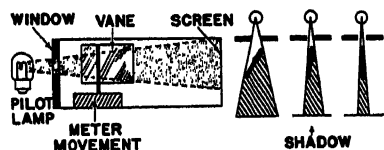

Shadow tuning indicator.

SHELF DEPRECIATION

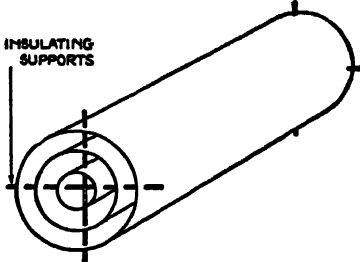
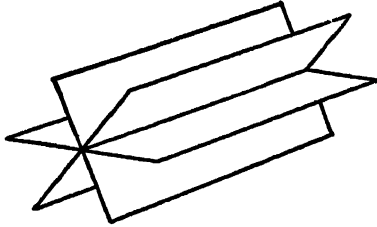

When sheet gratings like these are inserted in circular wave guides, they effectively stop all waves except those at one predetermined frequency.

shelf depreciation The depreciation in service capacity of a primary cell while standing unused.

shell A group of electrons supposed to form part of the outer structure of an atom and have a common energy level.

shellac Purified lac resin, used extensively in insulating materials, varnishes, sealing waxes, and molded products. It is generally the principal ingredient in commercial phonograph records.

shell-type transformer A power transformer in which all the primary and secondary coils are placed together, and the iron core is then built through and around the coils, so that the magnetic return paths outside the coils provide mechanical protection.

shf Abbreviation for superhigh-frequency, a Federal Communications Commission designation for the band from 3,000 to 30,000 megacycles in the radio spectrum. Same abbreviation used for noun as for adjective.

shield A metal housing placed around a circuit component to prevent interaction of its electric and/or magnetic fields with those of near-by parts.

shielded ignition wiring Ignition system wiring that is completely enclosed by grounded metal, usually flexible braided steel mesh connected to the engine and metal frame at frequent intervals. Used in automobiles, airplanes, and other mobile equipment to eliminate electric interference with radio reception.

shielded line A transmission line whose elements confine propagated radio waves to an essentially finite space inside a tubular conducting surface called the sheath, thus preventing the line from radiating radio waves.

shielded pair A two-wire transmission line surrounded by a metallic sheath.

shielded wire Insulated wire covered with a metal shield, usually of tinned braided copper wire.

shielded X-ray tube An X-ray tube enclosed in a grounded metal container except for a small window through which X rays emerge.

shield-grid thyratron A thyratron having a shield-grid envelope surrounding the cathode and usually placed at cathode potential, with a control grid in the form of a small ring guarding the exit hall at the top of the shield grid. Another part of the shield almost completely surrounds the anode and shields the control grid from the action of the anode. This arrangement prevents the control grid from being heated by the cathode or contaminated by material evaporated or knocked from the cathode.

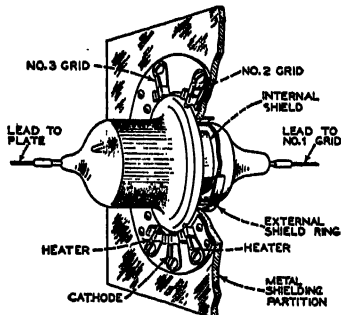

Typical shielding arrangement for a uhf vacuum tube.

SHORT-WAVE DIATHERMY

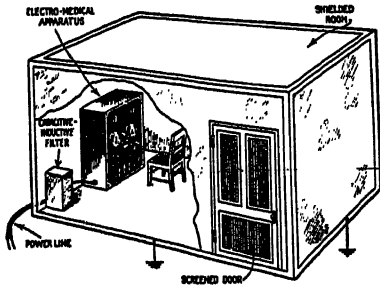

Shielded room for diathermy machine.

shielding Metal covering used on a wire or device to prevent undesirable radiation or pickup of signals.

shielding harness A complete shielding assembly, such as that used for the ignition system of an aircraft engine.

Ship Act The act approved June 24, 1910, as amended, requiring apparatus and operators for radio communication on certain Great Lakes steamers.

ship error A radio direction finder error due to reradiation of radio waves by the metal structure of a ship.

ship service A radio communication service of public correspondence carried on between ship stations and coastal stations or between ship stations and maritime mobile stations.

ship station A radio station licensed for ship service which is located on board a ship actually afloat and not permanently moored.

shock The sudden pain, convulsion, unconsciousness, or death produced by the passage of electric current through the body.

shock excitation Initiation of oscillations in a resonant circuit of a vacuum-tube oscillator by the pulse due to application of electrode voltages.

shock reception Reception of signals from a powerful near-by radio station regardless of how a radio receiver is tuned, due to forced oscillations.

shock therapy The use of an electric current to induce convulsions in the treatment of certain types of insanity and for other medical purposes. Also

called *electronarcosis* and *electric shock therapy*.

shore effect Bending of waves toward the shore line when traveling over water, due presumably to the slightly greater velocity of radio waves over water than over land. This effect causes errors in radio-direction-finder indications.

shore-to-ship communication Radio communication between a shore station and a ship at sea.

short A short circuit.

short circuit A low-resistance connection across a voltage source or between both sides of a circuit or line, usually accidental and usually resulting in excessive current flow that may cause damage.

shorted out Made inactive by connecting a heavy wire or other low-resistance path around a device or portion of a circuit.

shorting-contact switch A selector switch in which the width of the movable contact is greater than the distance between contact clips, so that the new circuit is contacted before the old one is broken. This avoids noise during switching.

short-time rating The rating defining the load that a machine, apparatus, or device can carry for a definitely specified short period of time.

short-wave converter A vacuum-tube unit designed to be connected between a receiver and its antenna system to permit reception of frequencies higher than those the receiver ordinarily handles. It consists essentially of an oscillator-mixer-first detector stage like that in a superheterodyne receiver, used to convert the high-frequency signals to a broadcast-band frequency to which the receiver can be tuned.

short-wave diathermy The use of frequencies in the range from about 20 to 75 megacycles to produce internal or surface heating of a person for medical treatment.

SHORT WAVES

short waves A general term usually applied to wavelengths shorter than broadcast-band wavelengths of 200 to 500 meters, corresponding to frequencies higher than the highest broadcast-band frequency of about 1,600 kilocycles.

short-wave transmitter A radio transmitter that radiates short waves, ordinarily shorter than 200 meters.

shot effect See *Schottky effect*.

shower The production of two or more associated ion pairs at the same instant, apparently due to cosmic rays.

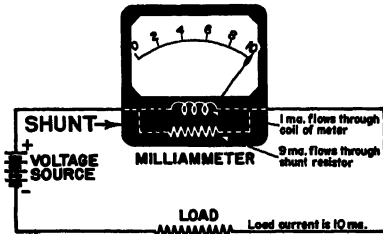

Use of a shunt in a milliammeter to increase the current range.

shunt 1. A precision low-value resistor placed across the terminals of an ammeter to increase its range by allowing a definite part of the circuit current to go around the meter. 2. Any part connected in parallel with some other part. 3. To place one part in parallel with another.

shunt feed Parallel feed, in which direct operating voltages are applied to the electrode of a vacuum tube through a circuit that is parallel to, and hence separated from, the signal circuit.

shunt field That part of the magnetic flux produced in a machine by the shunt winding (connected across the voltage source).

shunt leads The pair of leads that connects the current circuit of an instrument to a shunt. These leads are essentially a part of the instrument, and should not be shortened or otherwise altered.

shunt loading Loading in which reactances are applied in shunt across the conductors of the line.

shunt neutralization Providing a reactance path externally from the plate to the grid of a radio-frequency amplifier tube to offset the effects of the grid-plate interelectrode capacitance. The external path may be a variable capacitor in series with an inductor.

shunt-wound In a motor or generator, having windings so designed that armature and field windings are in parallel.

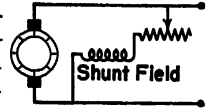

Shunt-wound motor.

shutter A device that prevents light from reaching the light-sensitive surface in an ordinary or television camera except during the desired period of exposure.

Si Chemical symbol for silicon.

sideband A band of frequencies on both sides of the carrier frequency of a modulated radio signal, including components whose frequencies are, respectively, the sum and difference of the carrier and the modulation frequencies. The sum frequencies form the upper sideband, and the difference frequencies form the lower sideband.

side frequency One of the sum or difference frequencies on either side of the carrier frequency, produced by the modulation of a carrier.

side tone The transmission and reproduction of sounds through a local path from the transmitter (microphone) to the receiver (headphone) of the same telephone station.

siemen A name proposed at one time for a unit of energy equal to 1 watt-hour, and later for the unit of conductance (now called mho).

Siemens A Siemens and Halske trade name for a synchronous device like the Autosyn, mag-slip, motor-torque generator and selsyn, all of which are equivalent to the universal term synchro.

Siemens electro-dynamometer A moving-coil or dynamometer-type instrument for current or power measure-

SIGNAL-TRACING INSTRUMENT

ments, consisting of vertically mounted fixed and movable coils that are at right angles to each other in the zero position and tend to become parallel when current passes through them.

Siemens unit An absolute unit of resistance proposed in Germany in 1860, being that of a column of mercury one meter long and one square millimeter in cross-section at 0° centigrade, equal to 0.9407 international ohm.

signal The form or variation of a wave with time, serving to convey the information, message, effect, or other desired intelligence in communication.

signal converter A cathode-ray tube about the size of an ordinary radio receiving tube, used to generate sweep voltages for the cathode-ray picture tube in a television receiver. Developed in Great Britain in 1943 (Nagard Type I and Type II).

signal generator A test instrument that can be set to generate an unmodulated or tone-modulated radio-frequency signal at any frequency needed for aligning or servicing radio receivers and amplifiers. Also called an *all-wave oscillator*, *all-wave signal generator*, *oscillator*, or *test oscillator*.

signaling key The key used in wire telegraphy or radiotelegraphy to control the sequence of the current impulses that form the code signals.

signal lamp A lamp that indicates the existence of certain conditions in a circuit by its illumination and extinction, as signal lamps on switchboards or pilot lamps in radio sets.

signal-lamp relay A relay controlling the circuit of a signal lamp.

signal-noise ratio 1. The ratio of the radio field intensity of a desired radio wave at a given point to the radio noise field intensity at that point. 2. The ratio, at a given location, of some measure of the desired signal to the same measure of the total noise.

signal plate The metal plate that backs up the mica sheet containing the mosaic in one type of cathode-ray television camera tube. The capacitance

existing between this plate and each globule of the mosaic is acted on by the electron beam to produce the television signal.

signal-shaping network An electric network inserted in a telegraph circuit, usually at the receiving end, to improve the wave shape of the signals.

signal shifter A variable-frequency vacuum-tube oscillator intended for use with amateur radio transmitters to permit shifting to a less crowded frequency within a given band.

signal strength The strength of the signal produced by a radio transmitter at a particular location, usually expressed as millivolts per meter of effective height of the receiving antenna employed.

signal-strength meter 1. An S meter. 2. A vacuum-tube oscillator that is tuned to the frequency of an incoming radio signal. It is connected to a receiver and is adjusted until the signal strength is the same as when the receiving antenna is connected to the receiver.

signal-to-noise ratio See *signal-noise ratio*.

signal tracing A radio-receiver servicing technique that involves tracing the progress of a radio signal through each stage of a receiver in order to locate the faulty stage.

signal-tracing instrument A test instrument designed to permit tracing the progress of a radio signal through radio equipment.

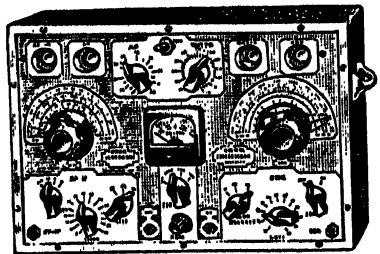

Signal-tracing instrument, having four cathode-ray tuning indicators. Used chiefly for locating trouble in radio receivers.

SIGNAL VOLTAGE

signal voltage The effective (root-mean-square) voltage value of a signal.

signal wave A wave whose characteristics permit some intelligence, message, or effect to be conveyed.

signal-wave envelope The contour of a signal wave that is composed of a series of wave cycles.

signature The sound effect or musical rendition used regularly to start or end a particular radio program.

silencer An enclosing vessel used to reduce the noise made by the spark in early spark-type radio transmitters.

silent discharge A gradual and non-disruptive discharge of electricity from a conductor into the atmosphere. Sometimes accompanied by the production of ozone.

silent period A period during each hour in which ship and shore radio stations must remain silent and listen for distress calls.

silicon A metallic element often mixed with iron or steel during smelting to provide desirable magnetic properties for transformer core material.

silicon detector A crystal detector consisting of a metal contact held against a piece of silicon that is in a particular crystalline state, used to rectify or detect radio signals.

silicon steel Steel containing 3 to 5 per cent silicon, having desirable magnetic qualities for use in the iron cores of transformers and other alternating-current devices.

silk-covered wire Wire covered with one or more layers of fine floss silk. It is superior to cotton insulation because of its better insulating qualities per given thickness of covering and better moisture-resisting properties, and because it permits getting more turns of a given wire in a given space.

silver A precious metal having better electrical conductivity than copper, used for contact points of relays and switches because it does not readily corrode. The chemical symbol is Ag.

simplex circuit A circuit that can be used simultaneously for telephony and

for direct-current telegraphy or signaling, separation between the two being accomplished by using the sides of the circuit in parallel for telegraph operation or signaling.

simplex operation Operation of a telegraph system in only one direction at a time. In radiotelegraphy this may involve using the same antenna alternately for transmission and reception.

simplex telegraphy Telegraphy employing simplex operation.

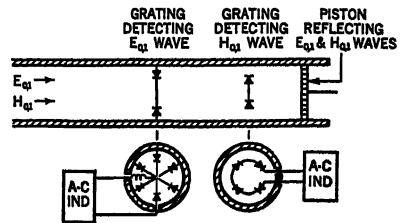

Simultaneous reception of two waves propagated through a guide, by means of separate detecting gratings having the cross-section shapes shown below. Crystal detectors in the gratings convert the wave energy into suitable form for a sound or television receiver or other alternating-current indicating equipment.

simultaneous reception Reception and detection of two distinct radio waves simultaneously propagated through a wave guide. A separate detecting grating with one or more crystal detectors is required for each wave. The waves may differ in type, in frequency, or in the orientation of their fields. With a quarter-wave termination, the same piston may serve as a reflector for both waves, and the two detecting gratings can be spaced ahead of the piston about one quarter of the wavelength of the wave to be detected, or an odd multiple thereof.

sine galvanometer An instrument resembling a tangent galvanometer except that its coil is in the plane of the deflecting needle. The sine of the angle of deflection is then proportional to the current.

sine wave The wave corresponding to any periodically varying quantity having the waveform of a sine curve. It rises from zero to a maximum in one direction, returns to zero in a corresponding gradual and nonuniform

SINGLE OPERATION

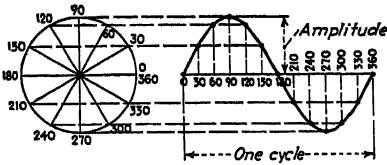

Steps in constructing a sine wave.

1. Draw circle with radius equal to amplitude of desired sine wave.
2. Divide circle into 12 equal parts with a 30°-60° triangle, and label circle intersections from 0° to 360°.
3. At right of center of circle, draw a horizontal line with length corresponding to desired time distance for one cycle.
4. Divide the line into 12 equal parts and label them from 0° to 360°.
5. Project vertically and horizontally from each pair of corresponding labeled points, and place a dot at the point of intersection.
6. Connect dots together with smooth curve to get sine wave. Construction lines can now be removed.

manner, reverses its direction and reaches a maximum in the opposite direction, then returns to zero again during each complete cycle.

singing An undesired self-sustained oscillation existing in a transmission system.

singing arc A direct-current electric arc that generates an audio-frequency current and corresponding sound waves when an inductor and capacitor are connected in parallel with the arc, giving a musical tone. Also called *Druddell arc*.

singing point The limiting efficiency that a circuit or transmission system can have without singing.

singing spark A spark occurring at an audio-frequency rate, producing a singing note. Used in early quenched spark systems of radiotelegraphy.

single-button carbon microphone A microphone having a carbon-filled button-like container on only one side of its flexible diaphragm. Movements of the diaphragm due to sound waves cause the resistance of the button to change, so

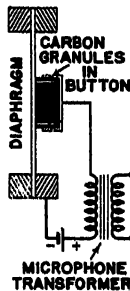

Single-button carbon-microphone circuit.

that the microphone current constitutes the desired audio-frequency signal.

single-dial control Control of a number of different devices or circuits by means of a single adjustment, as in tuning all variable capacitor sections of a radio receiver for reception of a particular signal frequency by adjusting a single knob.

- 1 METAL ENVELOPE
- 2 SPACER SHIELD
- 3 INSULATING SPACER
- 4 MOUNT SUPPORT
- 5 CONTROL GRID
- 6 COATED CATHODE
- 7 SCREEN
- 8 HEATER
- 9 SUPPRESSOR
- 10 PLATE
- 11 BATALUM GETTER
- 12 CONICAL STEM SHIELD
- 13 HEADER
- 14 GLASS SEAL
- 15 HEADER INSERT
- 16 GLASS-BUTTON STEM SEAL
- 17 CYLINDRICAL BASE SHIELD
- 18 HEADER SKIRT
- 19 LEAD WIRE
- 20 CRUMPLED LOCK
- 21 OCTAL BASE
- 22 EXHAUST TUBE
- 23 BASE PIN
- 24 EXHAUST TIP
- 25 ALIGNING KEY
- 26 SOLDER
- 27 ALIGNING PLUG

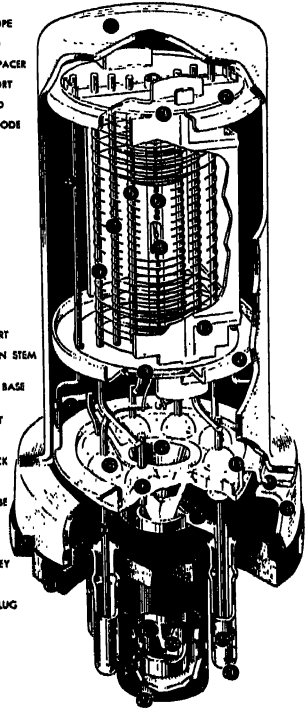

Single-ended metal tube, with portions cut away to show internal construction. A cylindrical base shield (17) inside the aligning plug permits bringing the control grid lead out through a base pin without feedback trouble.

single-ended tube A metal tube in which all electrode connections, including the control grid, are made to base pins, there being no top pin. The letter S after the first numeral in a receiving tube designation, as in 12SK7, indicates a single-ended tube.

single operation Same as *simplex operation*.

SINGLE-PHASE

single-phase Pertaining to a circuit or device that is energized by a single alternating voltage.

single-phase circuit A circuit energized through only two wires, or a circuit so energized that the voltages applied between all pairs of points of entry of power are in phase.

single-phase synchronous generator A generator that produces a single alternating voltage at its terminals.

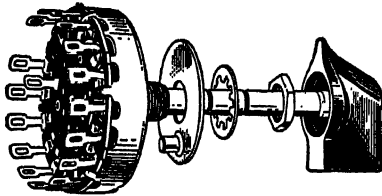

Single-gang selector switch, frequently used in multirange meters and other tap-switching applications.

single-pole switch A switch having only one movable contact element. It may be arranged for single-throw or double-throw operation or may employ a rotating arm as in a single-gang selector switch.

single-sideband system A type of radio-telephone service in which one set of sidebands (either the upper or lower) is completely suppressed and the transmitted carrier is partly suppressed.

single-sideband transmission That system of carrier transmission in which one sideband is transmitted and the other sideband is suppressed. The carrier wave may be either transmitted or suppressed.

single-sideband transmitter A radio transmitter in which one sideband is transmitted and the other is effectively eliminated.

single-signal receiver A superheterodyne receiver equipped for single-signal reception, with the crystal filter usually located in the intermediate-frequency amplifier and arranged so the crystal can be shorted out by a switch when high selectivity is not needed.

single-signal reception Reception involving the use of a piezoelectric quartz

crystal and associated coupling circuits as a crystal filter to provide a high degree of selectivity as required for reception of a single station in a crowded communication band.

single-throw switch A switch in which each movable contact element acts always in the same circuit, serving only to open or close that circuit.

single-wire line A transmission line that utilizes the ground as one side of the circuit.

sink A power-consuming device, such as the load in a circuit.

sinoidal Sinusoidal.

sinusoidal Varying in proportion to the sine of an angle or time function. Ordinary alternating current is sinusoidal.

sinusoidal field A field in which the magnitude of the scalar or vector quantity at any point varies as the sine or cosine of an independent variable such as time or displacement.

sinusoidal therapy Application of ordinary alternating current to a patient for curative purposes.

sinusoidal wave A wave whose displacement varies as the sine or cosine of an angle that is proportional to time or distance, or both.

siphon recorder A recorder consisting essentially of a sensitive moving-coil galvanometer, with a glass siphon or pen that is deflected by the moving coil and moves over a traveling strip of paper without touching the paper. The pen is charged with a simple motor-driven static machine known as a mouse mill, to make the ink flow freely. Originally introduced by Kelvin for recording weak signals of submarine cables.

six-electrode tube A hexode.

skew In facsimile, the deviation of the received frame from rectangularity due to lack of synchronism between scanner and recorder. Skew is expressed numerically as the tangent of the angle of this deviation.

skiagram An X-ray photograph.

skiagraph An X-ray photograph.

skiatron A cathode-ray tube device in which a crystalline screen having the property of electron opacity is exposed to the modulated and deflected cathode-ray beam. The scene can be rendered opaque in proportion to picture signal intensity at each elemental area scanned by the beam, thus permitting its use in a projection television system.

Skinderviken button A compact metal container filled with granules of carbon, used as a microphone.

skin effect Concentration of current density toward the surface of a conductor due to a self-induced counter electromotive force of an alternating current. It results in an increase in the effective resistance, with the effect being especially noticeable at radio frequencies because skin effect increases with frequency.

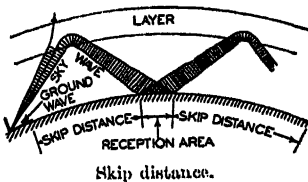

skip distance The minimum distance at which radio waves of a specified frequency can be transmitted at a specified time between two points on the earth by reflection from the regular ionized layers of the ionosphere.

Skrivanoff cell A primary cell having zinc and silver electrodes in an electrolyte of caustic potash, with silver chloride on the positive pole as a depolarizer.

sky wave A radio wave that is propagated by reflection from the ionosphere. Sometimes called *ionospheric wave*.

slab A relatively thick cut taken from a natural quartz crystal, for dividing into blanks by subsequent transverse cutting.

slc Abbreviation for straight-line capacitance. Obtained in a variable capacitor when the rotor plates are so shaped that the capacitance varies directly in proportion to the angle of rotation.

sleeve The cylindrical contacting part immediately back of the ring in a telephone-type plug.

slewing Moving a director or other aiming device rapidly in a horizontal or vertical direction, or both.

slewing motor The motor used in gun directors and in radio detecting and ranging equipment to move the aiming device rapidly in a horizontal or vertical direction or both when picking up and tracking a target.

slf Abbreviation for straight-line frequency. Obtained in a variable capacitor when the rotor plates are so shaped that the resonant frequency of the tuned circuit containing the capacitor varies directly in proportion to the angle of rotation.

slide-back An instrument used in radio transmitters to indicate the amount of grid current present in the modulating system.

slide-back voltmeter A vacuum-tube voltmeter that measures effective voltage values indirectly by measuring the change in grid bias voltage required to restore the plate current of the vacuum tube to the value it had before the unknown voltage was applied to the grid circuit.

slider A sliding type of movable contact.

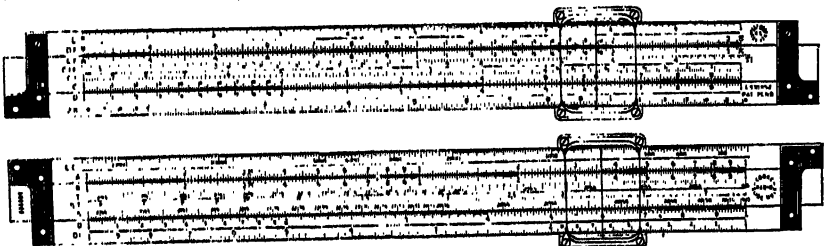

Front and rear views of Cooke Radio Slide Rule.

SLIDE-RULE DIAL

slide-rule dial A radio receiver tuning dial in which a pointer moves in a straight line over long straight scales resembling the scales of a slide rule.

slide wire A bare length of resistance wire used as a continuously variable resistance by means of a slider arrangement that can be set to any point along the length of the wire.

slide-wire bridge A bridge circuit in which the resistance in one or more branches is controlled by the position of a sliding contact on a length of resistance wire stretched along a linear scale.

slide-wire rheostat A rheostat constructed in the form of a long single-layer coil of resistance wire, with a sliding contact that can be moved to any desired position on the coil in order to vary the resistance.

sliding contacts Relay or switch contacts that close with a sliding motion giving a self-cleaning action.

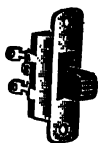

Slide switch.

slip The difference between the operating speed and the synchronous speed (the speed of the rotating field) of an induction machine. It may be expressed as a percentage of synchronous speed, as a decimal fraction of synchronous speed, or directly in revolutions per minute.

slip rings The collector rings mounted on the rotor shaft of an alternating-current generator to transfer the current to the external circuit through brushes pressing against the slip rings.

slope The essentially linear portion of the grid-voltage-plate-current characteristic curve of a vacuum tube, on which the operating point is chosen when linear amplification is desired.

slot One of the grooves formed in the iron core of a motor or generator armature for the conductors forming the armature winding.

slot coupling A method of transferring energy between a coaxial cable and a wave guide by means of two coincident

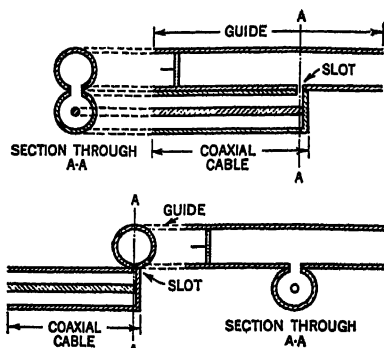

Slot coupling for connecting a coaxial cable to a circular wave guide when the two lines are parallel (above) and at right angles to each other (below).

narrow slots, one in the sheath of the guide and the other in the sheath of the coaxial cable. If the cable and guide are parallel to each other, H waves are launched into the guide. If perpendicular to each other, TE waves are launched into the guide.

slotted rotor plate A rotor plate having radial slots to permit bending different sections of the plate either inward or outward to adjust the total capacitance of a variable capacitor section during alignment. Also called *serrated rotor plate*.

slow-acting relay A time-delay relay in which an interval of several seconds may exist between energizing of the coil and pulling up of the armature. The delay can be obtained electrically by placing a solid copper ring on the core of the relay.

slow-release relay A time-delay relay in which there is an appreciable delay between deenergizing of the coil and release of the armature.

slug A heavy metal ring or short-circuited winding placed on the core of a telephone relay or other relay to give a time delay in its operation.

slw Abbreviation for straight-line wavelength. Obtained in a variable capacitor when the rotor plates are so shaped that the wavelength of resonance in the tuned circuit containing the capacitor varies directly in proportion to the angle of rotation.

Smee cell A primary cell having electrodes of zinc and platinized silver in dilute sulphuric acid. Now obsolete.

S meter A meter used in some communications receivers to indicate the strength of the received signal in arbitrary units.

smoke deposition Electrostatic precipitation of smoke at chimney tops, involving charging of solid particles by a high-voltage discharge so that the particles are attracted to charged electrodes and thereby collected.

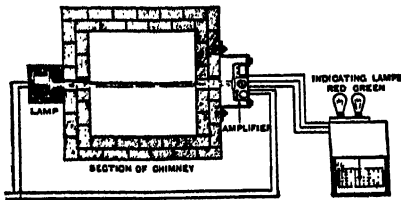

Smoke detector circuit.

smoke detector A photoelectric system for actuating an alarm when smoke in a chimney exceeds a predetermined density.

smoothing choke An iron-core choke coil employed as a filter to remove fluctuations in the output current of a vacuum-tube rectifier or direct-current generator.

smoothing circuit A combination of inductance and capacitance employed as a filter circuit to remove fluctuations in the output current of a vacuum-tube rectifier or direct-current generator.

smoothing factor A factor expressing the effectiveness of a filter in smoothing ripple-voltage variations.

smoothing filter A filter used to remove fluctuations in the output current of a vacuum-tube rectifier or direct-current generator.

smothered-arc furnace An arc furnace in which the heat-producing arc is covered by a portion of the charge.

SMPE Abbreviation for Society of Motion Picture Engineers.

snake A tempered steel wire, usually of rectangular cross-section, which is

pushed through a conduit or between a partition or other inaccessible space and used to pull electric wires through that space. Also called *fishing wire*.

snap magnet A permanent magnet used in thermostatic, pressure, and other types of control instruments to provide quick make-and-break action at the contact and thereby minimize sparking. The magnet pulls the armature in suddenly against spring action to close the contacts, and holds the contacts closed until spring action is enough to make them fly apart.

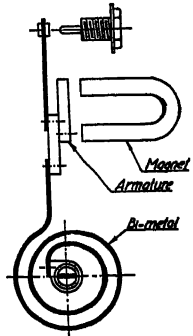

Thermostat Control

Horseshoe-shaped permanent magnet used as snap magnet on thermostat control to reduce sparking at the contacts.

snap switch Any switch in which the contacts are separated or brought together suddenly by the action of a spring placed under tension or compression by the operating knob or lever.

sneak current A leakage current that gets into telephone circuits from power circuits. It is too weak to cause immediate damage, but can produce harmful heating effects if allowed to continue.

Snook rectifier A revolving four-arm rectifying switch driven by a synchronous motor, used to convert a high alternating voltage into a direct voltage for X-ray tubes.

socket 1. A device for mounting any radio part having plug-in terminals, such as tubes, plug-in coils, or plug-in crystal holders. Spring clips in properly positioned holes grip the terminal pins of the part that is plugged in.
2. A device intend-

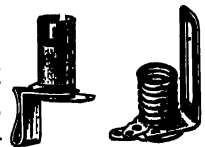

Pilot lamp sockets. Left—bayonet type; right—screw type.

solenoid An electromagnet having an energizing coil approximately cylindrical in form, acting on a movable ferromagnetic core or plunger positioned in the center of the coil.

solid conductor A conductor that is not divided into strands.

Solomon's unit A French unit of X-ray quantity, having a value of about 2.29 roentgens.

Solovox An electronic music generator designed for attachment to a piano, to provide organlike accompaniment to a piano rendition. It employs both oscillator and frequency divider circuits controlled by keys.

sonar A contraction of sound navigation and ranging. This term applies to equipment used for underwater detection of objects, determination of the distance or range to these objects, determination of ocean depth, determination of ocean-bottom profile, and underwater communication between ships. Sonar equipment utilizes frequencies in the audio and supersonic portions of the spectrum. For detecting and ranging, sonar equipment sends sound pulses through the water, picks up pulses reflected from underwater objects, measures electronically the elapsed time between departure and arrival of a pulse, and converts these data automatically into distance to the target. The principle is essentially the same as that employed in radar. For underwater communication, the sound is keyed according to the International code.

sonic Pertaining to or utilizing sound waves.

sonic altimeter An instrument for determining the height of an aircraft above the earth by measuring the time

taken for sound waves to travel from the aircraft to the surface of the earth and back to the aircraft again. The method is based on sound having a known velocity of 1,080 feet per second through dry air at 32° Fahrenheit.

sonic depth finder An instrument for determining the depth of water. Sound waves produced by a reproducer or transmitter on the hull of a vessel travel to the bottom and are reflected back to a special sound receiver that measures the interval of time between sending of the signal and receipt of its echo. From this, the depth is readily calculated or sometimes indicated directly by the instrument on the basis that sound waves travel through water at a velocity of 4,800 feet per second.

sonic frequencies Sound or audio frequencies, hence frequencies in the approximate range of 20 to 20,000 cycles.

sonometer A frequency meter depending on mechanical resonance with the vibrations of a variable length of a stretched wire.

SOS The distress signal in radiotelegraphy.

sound 1. A traveling vibration in air or some other elastic medium, involving alterations in pressure, particle displacement, or particle velocities. The term sound wave can be used for this concept to avoid confusion with sound sensation. Sound waves travel through air at a velocity of about 1,100 feet per second. Approximate velocities through other mediums are: steel, 16,400 feet per second; glass, 18,000 feet per second; water, 4,800 feet per second. 2. The sensation produced through the ear by sound waves, and specifically designated as sound sensation. This interpretation restricts sound waves to frequencies within the extreme limits of human hearing, namely, 20 to about 20,000 cycles. Frequencies above this range are classified as supersonic.

sound analyzer An electronic apparatus for measuring sound levels and ana-

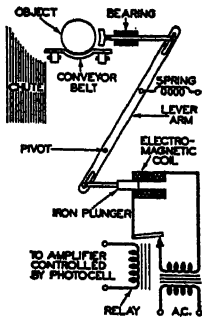

Solenoid, consisting of an electromagnet coil and an iron plunger, automatically pushes an object off a conveyor belt in response to a photoelectric sorter.

SOUND EFFECTS

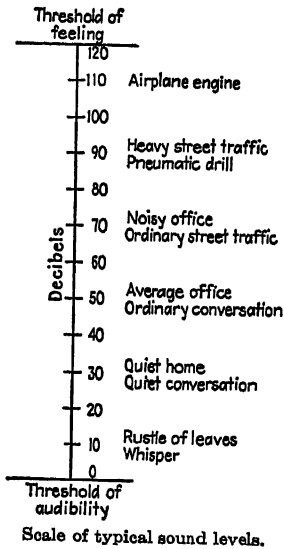

lyzing the frequency components that make up a sound. In one form it consists of a microphone, an amplifier, and a frequency analyzer having an arrangement of tuned circuits that permits measuring each component or harmonic separately.

sound effects Mechanical devices or recordings used to provide lifelike imitations of various sounds for use on radio programs.

sound energy density The sound energy per unit volume, in ergs per cubic centimeter.

sound energy flux The average over one period (one cycle) of the rate of flow of sound energy through any specified area. The unit is the erg per second.

sound energy flux density Sound intensity.

sounder A telegraph receiving instrument in which an electromagnet attracts an armature each time a pulse arrives. The armature makes an audible sound as it hits against its stops at the beginning and end of each current impulse, and the intervals between these sounds are translated from code into the received message by the operator.

sound film Movie film having a sound track at one side of the picture frames, for simultaneous reproduction of the sounds that are to accompany the film. A beam of light projected through the sound track is modulated at an audio-frequency rate by the variations in the width or density of the track, and these modulations are converted into audio-frequency signals by a phototube.

sound gate The mechanical device through which film passes in a sound-film projector for conversion of the sound track into audio-frequency signals that can be amplified and reproduced. In a television camera for pickups, a sound gate is used to obtain the sound accompaniment for the movie being televised. An exciter lamp, lens assembly, and phototube are associated with the sound gate.

sounding Determination of the depth of water or the altitude above the earth by any of several methods.

sound intensity The sound energy transmitted per unit of time in a specified direction through a unit area perpendicular to this direction at a point. It may be expressed in ergs per second per square centimeter or in watts per square centimeter. Also called *flux density* or *sound energy flux density*.

sound level meter An electronic instrument for measuring sound intensities. Its output meter may be calibrated in decibels or directly in units of sound intensity.

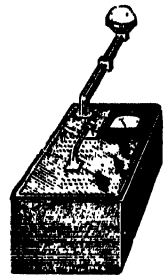

Sound level meter.

sound-on-disk recording Sound recording on conventional phonograph records.

sound panel 1. A movable panel of sound-absorbing material used in a broadcast studio to prevent sound reflections. 2. A hard-surfaced panel used to obtain reflections.

sound-powered telephone A telephone operating entirely on current generated by the speaker's voice, hence requiring no batteries. Sound waves cause a



Sound-powered telephones connect together all battle stations on combat vessels, and operate even though the ship's entire electrical power system is put out of commission. A modern battleship has over 2,000 of these instruments.

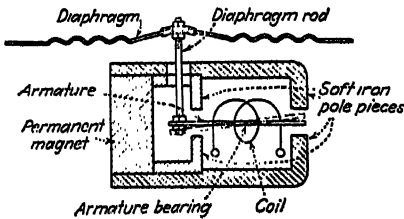

Operating principle of sound-powered telephone transmitters. For very loud talking, about 50 millivolts is generated in the coil.

coil to vibrate back and forth between the poles of a powerful but small permanent magnet, generating the required audio-frequency voltage.

sound pressure The root-mean-square value of the instantaneous sound pressure at a point over a complete cycle. The unit is the dyne per square centimeter. Also called *effective sound pressure*.

sound ranging Determination of the position of a gun by picking up at three widely separated points the sound waves produced by that gun and transmitting the resultant signal of each microphone over wire lines to a central station where the signals are photographically recorded by an

oscillograph. Differences in times of arrival of the microphone signals are determined from the record and converted into gun-position data by simple geometric calculations based on a speed of about 1,080 feet per second for sound waves in air.

sound sensation The sensation produced in the brain by a sound wave acting on the human ear or by sound vibrations acting directly on the bones of the head.

sound track That part of a sound movie film containing the variable-width or variable-density pattern representing the sound accompaniment of the film.

sound wave A traveling wave produced by vibrations in an elastic medium at a rate that can be heard.

source That part of a circuit which is supplying radio signals or electrical energy to the circuit.

south pole The pole of a magnet at which magnetic lines of force are assumed to enter. They emerge from the north pole.

space charge A charge of electricity distributed throughout a volume or space, as in the space near the cathode of a thermionic vacuum tube or phototube.

space-charge effect Repulsion of electrons emitted from the cathode of a thermionic vacuum tube by electrons accumulated in the space charge near the cathode, resulting in a reduction in plate current.

space-charge grid A grid placed adjacent to the cathode and positively biased with respect to the cathode, so as to reduce the limiting effect of the space charge on the current through a vacuum tube.

space-charge-grid tube A tube using a space-charge grid.

space current The current made up of electrons moving from the cathode to the anode and other positive electrodes in a thermionic vacuum tube.

SPACED ANTENNA

spaced antenna An antenna system consisting of a number of separate antennas spaced a considerable distance apart, used to minimize local effects of fading at short-wave receiving stations.

spaced-antenna direction finder A direction finder comprising two or more similar separate antennas spaced apart and coupled to a common receiver.

space diversity The difference in fading existing at different receiving antennas spaced a number of wavelengths apart. The effect is utilized by employing two or more antennas at different positions, each feeding its own receiver, and combining or switching receiver outputs in such a way that the resulting signal will at each instant be derived from the antenna at which the best signal-to-noise ratio exists at that instant.

spaced-loop direction finder A spaced antenna direction finder in which the individual antennas are loops.

space factor 1. The ratio of the space occupied by the conductors in a winding to the total cubic content or volume of the winding. 2. The ratio of the space occupied by iron to the total cubic content of an iron core.

space permeability The factor that expresses the ratio of magnetic induction to magnetizing force in a vacuum. In the centimeter-gram-second electromagnetic system of units, the permeability of a vacuum is arbitrarily taken as unity.

space phase Reaching corresponding peak values at the same point in space.

space quadrature A difference in the position of corresponding points of a wave in space by a distance equal to one-fourth of the wavelength in question.

space radio The art of communication by means of radio waves in free space.

spacing interval An interval between successive telegraph signal pulses during which there is no current flow or the current is of opposite polarity

to that employed for the signal pulses.

spacing wave A signal heard from a radiotelegraph transmitter when the sending key is open in between active portions of the code characters or between messages, due to improper neutralization of the radio-frequency amplifier in the transmitter. Also called *back wave*.

spade tuning A rough method of tuning a circuit, involving moving a spade-shaped flat piece of metal over the face of a spider-web or other flat coil to change the inductance.

spaghetti Linen or cotton fabric tubing impregnated with insulating oil and baked. Plastic materials are sometimes used in place of the oil.



Spade lug.

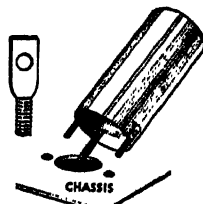

Spade bolt and typical use.

span The distance between adjacent supports of a transmission line or other overhead wire line.

spark A momentary flash due to an electric discharge through air or some other dielectric material.

spark coil An induction coil used to produce spark discharges.

spark frequency The number of sparks occurring per second in a spark transmitter. It is the group frequency of the trains of waves, not the frequency of the individual waves.

spark gap An arrangement of two electrodes between which a disruptive discharge of electricity (a spark) may occur. The insulation (usually air) between the electrodes is self-restoring after passage of the spark.

sparkling Intentional or accidental spark discharges, as between the brushes and commutator of a rotating machine, between contacts of a relay or switch, or at any other point at which an inductive circuit is broken.

spark voltage The minimum voltage at which a spark discharge occurs between electrodes of given shape at a given distance apart under given conditions.

spark killer A spark-suppressing device.

spark lag The time interval between attainment of the sparking voltage and the passage of a spark.

spark micrometer A spark gap so arranged that the length of the gap can be adjusted and accurately determined by means of a screw having an accurately graduated thread. Used to investigate sparking distances for different electrode shapes and different waveforms of voltages, or for approximate measurements of high voltages.

sparkover A disruptive discharge between the electrodes of a measuring gap such as a sphere gap or oil-testing gap.

spark photography 1. The process of obtaining a photograph of a rapidly moving object such as a bullet by illuminating the object suddenly with the light from a single electric spark. 2. Photography of sparks by means of their own light.

spark recorder A recorder in which the recording paper passes through a spark gap formed by a metal plate underneath and a moving metal pointer above the paper. Sparks from an induction coil pass through the paper periodically, burning small holes that form the record trace. This arrangement avoids the friction of a pen on paper.

spark spectrum The spectrum of a substance as produced with the light from a spark passing between terminals made of that substance or through an atmosphere of that substance.

spark therapy The use of sparks between an electrode and the skin to remove malignant growths. The instrument used for this purpose is called an *electrodesiccator*.

spark transmitter A radio transmitter that utilizes the oscillatory discharge of a capacitor through an inductor and a spark gap as the source of its radio-frequency power.

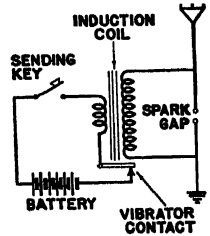

Spark transmitter (early Marconi circuit).

spark-type generator A high-frequency generator used for electronic heating purposes and employing much the same circuit as the spark transmitters used in the early days of radio.

spdt Abbreviation for single-pole, double-throw, applying to a switch used to connect one terminal to either of two other terminals.

speaker A loud-speaker. This short term is used frequently when usage is such as to make the meaning clear, as in a compound term like speaker field.



Speaker centering shim.

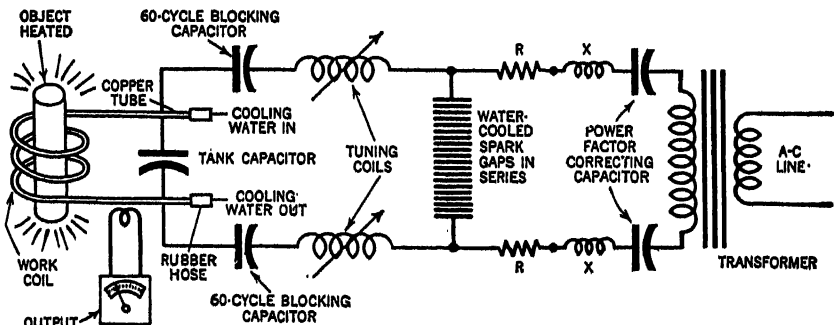

Basic spark-type high-frequency generator for induction heating of metals.

SPEAKING ARC

- speaking arc** A direct-current arc having audio-frequency currents superposed on the direct current. This causes the arc to reproduce sounds much as in a loudspeaker, and to vary its light output at an audio-frequency rate as required for sound-film recording purposes.
- special emergency station** A station used for communications by radio in emergencies in lieu of normal means of communication.
- specific conductivity** The conducting power of a material in mhos per cubic centimeter. It is the reciprocal of resistivity.
- specific dielectric strength** The dielectric strength per millimeter of thickness of an insulating material.
- specific gravity** The ratio of the weight of a substance to the weight of an equal volume of water. Thus, a specific gravity of 2 means that the substance is twice as heavy as water.
- specific inductive capacitance** That property of a dielectric material which determines how much electrostatic energy can be stored per unit volume when unit voltage is applied. In effect, it is the ratio of the capacitance of a capacitor filled with a given dielectric to that of the same capacitor having only a vacuum as dielectric. Also called *dielectric constant* and *permittivity*.
- specific reluctance** The ratio of the magnetic intensity H in a region to the magnetic induction B in that same region. Also called *reluctivity*.
- specific resistance** The resistance of a unit conductor having a length of one foot and a cross-sectional area of one circular mil.
- spectral radiant intensity** The radiant intensity per unit wavelength interval, such as watts per steradian per micron.
- spectrograph** An instrument that disperses radiation and records the resulting spectrum photographically.
- spectrometer** An instrument that disperses radiation and measures the deviations or wavelengths corresponding to the spectral lines, usually for color analysis.
- spectrophotoelectric** Pertaining to the dependence of photoelectric phenomena on the wavelength of the incident radiation.
- spectrophotometer** An instrument that measures transmission or apparent reflectance of light as a function of wavelength, permitting accurate analysis of color or accurate comparison of luminous intensity of two sources at specific wavelengths.
- spectrophotometric analysis** A method of quantitative analysis based on the spectral energy distribution in the absorption spectrum of a substance in solution.
- spectroradiometer** An instrument for determining the spectral energy distribution of any type of radiation, usually infrared.
- spectroscope** Any of several instruments used for spreading individual wavelengths in a beam of light and observing the resulting spectrum.
- spectrum** 1. The entire range of electromagnetic radiations, starting with the longest known radio waves and ending with the shortest known cosmic rays. Light, the visible portion of this great spectrum, lies about halfway between the two extremes. The spectrum of visible light consists of a band of color changing gradually from violet at one end to deep red at the other, just as in a rainbow. 2. All the frequencies used for a particular purpose. Thus, the radio spectrum extends from about 15,000 cycles to over 30,000 megacycles. 3. The result of dispersing an emission (such as light) in accordance with some progressive property, usually its frequency. The plural is spectra.
- spectrum analysis** The analysis of a chemical substance by means of the spectrum produced by heating the substance to incandescence.
- spectrum line** A definite wavelength or a narrow range of wavelengths,

corresponding to a distinct image of the spectroscope slit made by that wavelength. Also, one of the traces made by a mass spectrograph, corresponding to an atom having a particular mass.

specular reflection Reflection of light, sound, or radio waves from a surface so smooth that its inequalities are small in comparison with the wavelength of the incident rays, so that each incident ray gives rise to a reflected ray in the same plane. Also called *regular reflection*.

speech amplifier An audio-frequency amplifier, particularly one used chiefly for amplification of voices as in public address equipment or radio-telephone systems.

speech frequency An audio frequency in the range from about 100 to 2,000 cycles, which includes all components considered essential for intelligibility of speech.

speech inverter An apparatus for interchanging high and low speech frequencies by a method involving removal of the carrier wave and transmission of only one sideband in radiotelephony. This renders the speech unintelligible unless picked up by apparatus capable of replacing the carrier wave in the correct manner.

speech scrambler A more elaborate version of a speech inverter, involving division of the audio-frequency spectrum into more than two groups, inversion of frequencies in each group, and sometimes also further mixing of groups.

speed 1. A scalar quantity equal to the magnitude of velocity. Speed thus specifies no direction. 2. The rate of performance of an act. 3. The maximum relative aperture of a lens. 4. The minimum exposure time of a shutter.

speed regulator A device that functions to maintain the speed of a motor or other device at a predetermined value or vary it according to a predetermined plan.

sp gr Abbreviation for specific gravity.

sphaerophone A general term sometimes applied to any electronic instrument in which the frequency of the sound output is controlled by a variable capacitor.

sphere gap A spark gap between two equal-diameter spherical electrodes.

sphere-gap voltmeter A simple instrument for measuring high voltages, consisting of a sphere gap. The electrodes are moved together until the spark will just barely pass. The voltage can then be calculated from the gap spacing and the diameter of the electrodes or can be read directly on a previously calibrated scale.

sphere photometer A photometer in which the source of light to be measured is placed inside a sphere having white inside walls. The light reflected from these walls through a suitably placed opening is measured to obtain the mean spherical candlepower of the source.

spherical Having the form of a sphere or ball.

spherical aberration A general term for image defects that are due to the spherical form of a lens or mirror. These defects cause a blurred image because central and marginal rays are brought to different foci by the lens or mirror. Common types of spherical aberration are astigmatism and curvature of field.

spherical-earth attenuation The attenuation over an imperfectly conducting spherical earth in excess of that over a perfectly conducting plane.

spherical wave A wave whose wave-front is a spherical surface.

sp ht Abbreviation for specific heat.

sphygmogram A graphic recording of human pulse waves.

sphygmograph An apparatus for recording electrically the action of the pulse of a patient.

sphygmophone A special type of microphone attached to the wrist to pick up the sounds of the pulse and make

SPIDER

them clearly audible in a telephone receiver.

spider A highly flexible ring, washer, or punched flat member used to center the voice coil of a dynamic loudspeaker with respect to the pole piece without appreciably hindering in-and-out motion of the voice coil and its attached diaphragm.

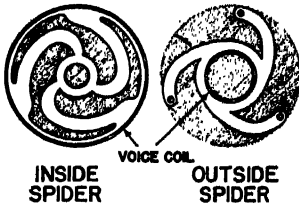

Examples of spiders used in dynamic loudspeakers.

spider-web antenna An all-wave receiving antenna having several different lengths of doublets connected somewhat like the web of a spider, to give favorable pickup characteristics over a wide range of frequencies.

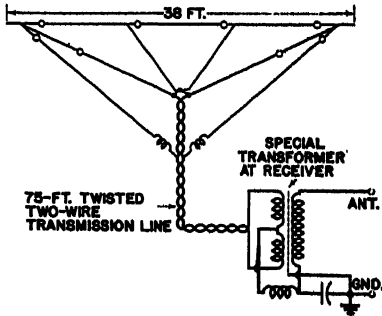

Spider-web antenna.

spider-web coil A flat coil having an open weave somewhat like the bottom of a woven basket, used in older radio receivers.

spinning electron A term used to describe an electron that is assumed to spin with an angular momentum of $h/4\pi$, in which h is Planck's constant.

spintharoscope An instrument for viewing the scintillations of alpha particles on a luminescent screen.

spiral four Spiral quad.

spiral quad A structural unit employed in telephone and telegraph cables, consisting of four separately insulated conductors twisted about a common axis. Also called *spiral four*.

spkr Abbreviation for loudspeaker.

splice A joint used for connecting two lengths of conductor or cable with good mechanical strength as well as good conductivity.

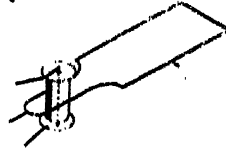
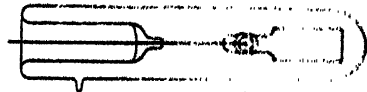

Split-anode magnetron tube with external (at top) and internal loop L serving as inductor, and detail of connections to internal loop which encloses the split anode.

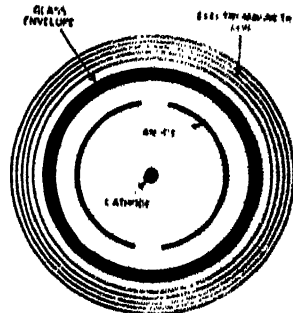

Cross-section of split-anode magnetron.

split-anode magnetron A magnetron in which the cylindrical anode is divided longitudinally into halves, between which extremely high-frequency oscillations are produced.

split magnetron A split-anode magnetron tube.

split-phase motor A single-phase induction motor having an auxiliary winding connected in parallel with the main

SQUARE-LAW DETECTOR

winding but displaced in magnetic position from the main winding so as to produce the required rotating magnetic field for starting. The auxiliary circuit is generally opened when the motor has attained a predetermined speed.

split rotor plates Rotor plates having radial cuts to permit bending portions of the plates during alignment in a receiver.

split-stator variable capacitor A variable capacitor having a rotor section that is common to two separate stator sections. Used in grid and plate tank circuits of transmitters for balancing purposes.

sponsor The person or firm paying a broadcast station and performers for a radio program in which a time is generally allotted to commercial advertising.

sporadic E layer That portion of the normal E layer in the ionosphere that sometimes breaks away and exhibits special erratic characteristics.

sporadic reflections Sharply defined reflections of radio waves from an ionized layer of the ionosphere, occurring at frequencies greater than the critical frequency or penetration frequency of the layer. Sometimes called *abnormal reflections*.

spot 1. The luminous area produced on the viewing screen of a cathode-ray tube by the electron beam. 2. A commercial announcement or short program ordinarily broadcast from only one station at a time, often from a transcription.

spot projection In facsimile, the optical method in which the scanning or recording spot is delineated by an aperture between the light source and the subject copy or record sheet.

spot speed In facsimile, the product of the length of scanning line by the number of scanning lines per second.

spottiness Bright spots scattered irregularly over the reproduced image in a television receiver, due to man-made

or static interference entering the television system at some point.

spot welding A resistance-welding process in which fusion is confined to a relatively small portion of the area of the lapped parts to be joined.

spreader An insulating crossarm used to hold apart the wires of a transmission line or multiple-wire antenna.

Sprengel pump A type of vacuum pump dependent on dropping of mercury down a tube.

spring contact A relay or switch contact mounted on a flat spring, usually of phosphor bronze.

spring-return switch A switch in which the contacts return to their original positions when the operating knob is released.

spst Abbreviation for single-pole, single-throw, applying to a switch used to connect or disconnect one pair of terminals.

spurious radiation Any emission from a radio transmitter at frequencies outside its operating frequency.

spurious response A condition in which a radio receiver is resonant at one or more other frequencies aside from that to which it is tuned.

sputtering The process of forming a thin film of metal on a surface by exposing it to particles of atoms knocked out from a cathode during bombardment by positive ions.

sq Abbreviation for square.

sq cm Abbreviation for square centimeter.

sq ft Abbreviation for square foot.

sq in Abbreviation for square inch.

sq m Abbreviation for square meter.

sq mm Abbreviation for square millimeter.

square-law detector A vacuum-tube detector circuit in which the output signal current strength is proportional

SQUARE MIL

to the square of the radio-frequency input voltage.

square mil An area equivalent to a square having sides 1 mil (0.001 inch) long.

square wave The waveform of a quantity that varies periodically from one to the other of two definite values, giving a square or rectangular pattern when amplitude is plotted against time.

squealing A condition in which a radio receiver produces a high-pitched note or squeal along with the desired radio program, due to interference between stations or to oscillation in some receiver circuit.

squegger oscillator A vacuum-tube oscillator producing short successive pulses of oscillations through the action of a grid leak that permits building up the grid bias to a blocking value during oscillating periods, with the bias dropping down to a restarting value between the oscillating periods.

squegging The condition of self-blocking in a vacuum-tube oscillator.

squelch circuit Any circuit that serves to reduce or squelch the noise otherwise heard in a radio receiver when no carrier signal is present at the input.

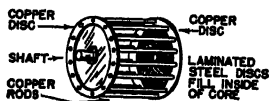

Squirrel-cage rotor.

squirrel-cage induction motor An induction motor in which the secondary circuit, usually the rotor, consists of a squirrel-cage winding (two disks connected along their circumference with copper bars) arranged in slots in the iron core.

ssc Abbreviation for single silk-covered wire.

sse Abbreviation for single silk covering over enamel insulation on wire.

stability Freedom from changes due to any cause, hence maintaining certain characteristics constant despite varying voltage, temperature, etc.

stabilivolt A gas-filled tube containing a number of concentric coated iron electrodes. Ionization is produced in the tube by applying a direct voltage between the innermost and outermost cylinders. The voltage between the intermediate electrodes remains remarkably constant through a considerable range of variation in the applied direct voltage, permitting use of the tube as a source of practically constant voltage for apparatus drawing only small currents.

stabilized feedback A vacuum-tube circuit arrangement in which a signal is fed back from the plate circuit to the grid circuit in such a way that it is 180 degrees out of phase with the input signal, decreasing the amplification. It is used in radio-frequency circuits to improve the stability by preventing oscillation, and in audio-frequency circuits to reduce distortion and noise so as to permit greater undistorted power output. Also called *degeneration*, *inverse feedback*, and *negative feedback*.

stacked array An array in which the half-wave antenna elements are stacked one above the other.

stacked dipoles Two or more dipole antennas arranged above each other on a vertical supporting structure.

stage 1. A circuit containing a single vacuum tube. In a multiple-tube circuit a stage is defined as all parts connected between the control grid of one tube and the control grid of the next adjacent tube. 2. A circuit containing two or more tubes connected in push-pull, push-push, or parallel, but serving the same function as a single-tube circuit.

stage-by-stage elimination method A method of locating trouble in radio receivers by checking performance of one stage after another with a test signal introduced by a signal generator.

stalloy A steel alloy containing about 2.75 per cent silicon with some manganese, sulphur, and phosphorus. Used for iron cores of transformers and also for headphone diaphragms because of its low hysteresis loss and high resistivity, resulting in low eddy-current loss.

stampers The plates from which phonograph records are stamped in presses.

stampings Laminations.

standard An exact value, or a concept that has been established by authority, custom, or agreement, to serve as a model or rule in the measurement of a quantity or in the establishment of a practice or procedure.

standard broadcast band The band of frequencies extending from 550 to 1,600 kilocycles, both 550 and 1,600 kilocycles being the carrier frequencies of broadcast channels.

standard broadcast channel The band of frequencies occupied by the carrier and two sidebands of a broadcast signal, with the carrier frequency at the center. Channels are designated by their assigned carrier frequencies. Carrier frequencies assigned to standard broadcast stations begin at 550 kilocycles and are in successive steps of 10 kilocycles.

standard broadcast station A station licensed for the transmission of radio-telephone emissions primarily intended to be received by the general public and operated on a channel in the band extending from 550 to 1,600 kilocycles.

standard cable A cable of particular size and construction, used as a standard in comparing the transmission constants of telephone cables and circuits, these being spoken of as equivalent per mile to so many miles of standard cable. The standard cable has a conductor weighing 20 pounds per mile, a loop resistance of 88 ohms per mile, a capacitance of 0.054 microfarad per mile, an inductance of 0.001 henry per mile, a leakage (reciprocal of insulation resistance between conductors) of 0.000001 ohm per mile, and an attenuation constant of 0.103.

standard candle The unit of candle-power, equal to a specified fraction of the visible light radiated by a group of 45 carbon-filament lamps preserved at the National Bureau of Standards, when the lamps are operated at a specified voltage. The standard candle was originally the amount of light radiated by a tallow candle of specified composition and shape.

standard capacitor A capacitor constructed in such a manner that its capacitance is not likely to vary, and having a convenient value such as 0.25 microfarad or some other accurately known value. Used chiefly in capacitance bridges.

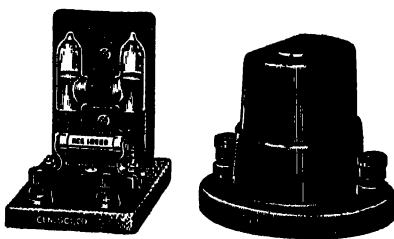

Standard cells. Left—Eppley cell for student use; right—Weston cell for laboratory calibration work, and producing a voltage of a definitely known value between 1.0184 and 1.0180 volts.

standard cell A primary cell whose voltage is accurately known and remains sufficiently constant for instrument-calibration purposes.

standard-frequency signal One of the highly accurate signals broadcast by the National Bureau of Standards radio station WWV on a frequency of 5,000 kilocycles and on other frequencies. Used for testing and calibrating radio equipment all over the world.

standard resistance A resistance carefully constructed so that its value is not likely to change except in a known manner with temperature. Its value is known at any time to a high degree of accuracy.

stand by 1. A command meaning that radio or television performers must be ready to go on the air in a few seconds. 2. A request to wait for

STANDBY

additional messages to be transmitted a short time later.

standby A radio program held in reserve for use in an emergency at a broadcast station, such as when some other program finishes before its allotted time.

standby battery A storage battery held in reserve as an emergency power source in event of failure of regular power facilities at a radio station or other location.

standing-wave ratio The ratio of current (or voltage) at a loop in a transmission line to the value at a node. It is equal to the ratio of the characteristic impedance of the line to the impedance of the load connected to the output end of the line.

standing waves Stationary waves.

stand-off insulator An insulator used to support a wire at a distance from a building or pole on which the insulator is mounted

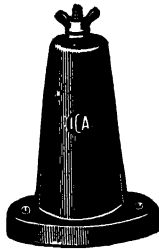

Stand-off insulator.

star circuit A network of three resistance or impedance elements arranged in the form of a Y or three-pointed star.

starter An electric controller for accelerating an electric motor from rest to normal speed. It may be automatic or manual.

starting anode An electrode used to establish the initial arc in a mercury-arc rectifier or similar tube.

starting current The minimum beam current required to maintain oscillation in a klystron. In theory, this current would be the electron current through the resonators. The use of the minimum emission or beam current is practical, however, since it includes the current lost by imperfect focusing.

state guard stations A station operated by a state for communication in connection with the activities of the State Guard or an equivalent officially recognized organization.

state police station A station used by a state police department for emergency radiotelephone service with mobile police units.

static Noise heard in a radio receiver due to atmospheric electrical disturbances such as lightning.

static characteristic A curve or other data showing the performance of a vacuum tube when used with only the direct operating voltages (no signal voltages).

static charge An electric charge accumulated on an object.

static electricity Electricity in the form of a charge in equilibrium, or considered independently of the effects of its motion.

static eliminator A device intended to reduce the effect of atmospheric static interference in a radio receiver. As yet, no device has been found that will eliminate static completely without impairing the reception of the desired signal.

static machine A machine for generating electric charges, usually by electric induction.

static pressure The pressure that would exist in a medium if no sound waves were present. The unit is the dyne per square centimeter.

static sensitivity In a phototube, the direct anode current divided by the incident radiant flux. Radiant flux here means ultraviolet and infrared as well as luminous flux. The luminous sensitivity rating applies to visible light only.

station An assembly of radio transmitting equipment, including the transmitting antenna.

stationary waves 1. The wavelike distribution of potential along a conductor when electric waves are reflected from the end of the conductor to form stationary nodes and loops. 2. A condition of equilibrium or zero motion at certain lines, points, or surfaces called nodes, with regions of vibration between, produced by interference

between similar wave trains (either sound waves or electromagnetic waves) traveling in opposite direction. Also called *standing waves*.

station license A license issued by the Federal Communications Commission authorizing construction and operation of a radio station under specified conditions.

stator 1. That portion of a rotating machine which contains the stationary parts of the magnetic circuit and their associated windings. 2. The stationary set of plates in a variable capacitor.

stator plates The fixed plates of a variable tuning capacitor. They are generally insulated from the frame of the capacitor and are connected to the grid or high-potential side of a tuned circuit.

ST broadcast station A station used to transmit programs from the main studio to the transmitter of a standard or international broadcast station. It must use frequency modulation, with a swing not to exceed 200 kilocycles, on a carrier frequency in the tentatively assigned band from 330 to 344 megacycles, and must have a directional antenna.

std Abbreviation for standard.

steady state The condition in which circuit values remain essentially constant, occurring after all initial transients or fluctuating conditions have settled down.

stearite A mineral consisting chiefly of a silicate of magnesium, having excellent insulating properties even at high frequencies and therefore used extensively for insulators in radio equipment and in other applications where its heat-resisting properties are advantageous.

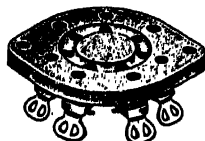

Stearite water socket.

Stefan-Boltzmann law The emitted radiant energy per unit of a blackbody is proportional to the fourth power of its absolute temperature.

Steinmetz coefficient The factor by which the 1.6th power of the magnetic flux density must be multiplied to give the approximate hysteresis loss of an iron or steel sample in ergs per cubic centimeter per cycle when that sample is undergoing magnetization cycles having that value of flux density as a maximum.

Steinmetz formula An empirical formula (created by experiment) for the magnetic hysteresis loss per unit volume per cycle: $w = aB_m^{1.6}$, when a is the Steinmetz coefficient and B_m is the maximum induction during the cycle. It is used in the design of power transformers.

Stellite A tungsten alloy sometimes used for the tip of a cutting stylus for a sound recorder.

stenode circuit A superheterodyne receiving circuit in which a piezoelectric unit is used in the intermediate-frequency amplifier to balance out all frequencies except signals at the crystal frequency, thereby giving very high selectivity.

stepdown transformer A transformer in which energy is transferred from a high-voltage primary winding to one or more low-voltage secondary windings having fewer turns than the primary.

step-up transformer A transformer in which energy is transferred from a low-voltage primary winding to one or more high-voltage secondary windings having more turns than the primary.

stereophonic reception Reception involving the use of two receivers having a phase difference in their reproduced sounds, to give a sense of direction to the received program analogous to the impression of depth obtained in stereoscopic vision.

stereoscope An optical instrument designed to give a mental impression of a three-dimensional scene through a viewing of two properly prepared pictures or photographs.

STEREOSCOPIC

- stereoscopic** Having a three-dimensional character.
- Sterilamp** An ultraviolet lamp used for destroying bacteria.
- stethoscope** In the electric version, a microphone used with or without an amplifier to permit listening to the sounds of the human body.
- stilb** A unit of brightness equal to one candle per square centimeter.
- Stokes' law** The wave length of luminescence excited by radiation is always greater than that of the exciting radiation. The law has some exceptions.
- stop** The aperture or useful opening of a lens, usually adjustable by means of a diaphragm.
- stopping capacitor** A capacitor used to introduce a comparatively high impedance in some branch of a circuit to limit the flow of low-frequency alternating current or direct current without materially affecting the flow of high-frequency alternating current. Also called *blocking capacitor*.
- stopping potential** The voltage required to stop the outward movement of electrons emitted by photoelectric or thermionic action. It is used to determine the speed of the emitted electrons.
- storage camera** An electronic television pickup, in which the picture is projected optically on the mosaic electrode of a cathode-ray tube and is scanned by an electron beam to convert the optical image into corresponding electrical impulses. Also called *iconoscope*.
- storage cell** An electrolytic cell for the generation of electric energy, in which the cell after being discharged may be restored to a charged condition by an electric current sent through the cell in a direction opposite that of the discharging current. Also called *secondary cell*.
- storage battery** A connected group of two or more storage cells. Common usage permits application of this term to a single cell used independently.
- Also called *secondary battery*. Corresponding British term is *accumulator*.
- storage-type camera tube** A television cathode-ray camera tube similar to the iconoscope, in which the image is projected on a photosensitive plate and elemental areas of the plate build up their charges gradually until discharged by the moving electron beam. Each area thus develops a picture signal that is proportional to its illumination.
- straight-line capacitance** A variable capacitor characteristic obtained when the rotor plates are so shaped that the capacitance varies directly in proportion to the angle of rotation.
- straight-line frequency** A variable capacitor characteristic obtained when the rotor plates are so shaped that the resonant frequency of the tuned circuit containing the capacitor varies directly in proportion to the angle of rotation.
- straight-line wavelength** A variable capacitor characteristic obtained when the rotor plates are so shaped that the wavelength of resonance in the tuned circuit containing the capacitor varies directly in proportion to the angle of rotation.
- strain** The actual change in the shape of an object occurring during application of force. Strain is produced by stress.
- strain gage** A small instrument designed to be attached to a member in which strain is to be measured. It is usually connected into a bridge circuit that feeds a recorder either directly or through an amplifier. The three types in common use are electric, electromagnetic, and resistance strain gages.
- strain insulator** An insulator inserted in a guy wire, antenna, or other stretched wire to break up the wire into insulated sections. It is designed to withstand the entire pull in the wire.
- strand** One of the wires, or one of the groups of wires, of any stranded conductor.
- stranded wire** A conductor composed of a group of wires or of any combination

STROBOSCOPIC DIRECTION FINDER

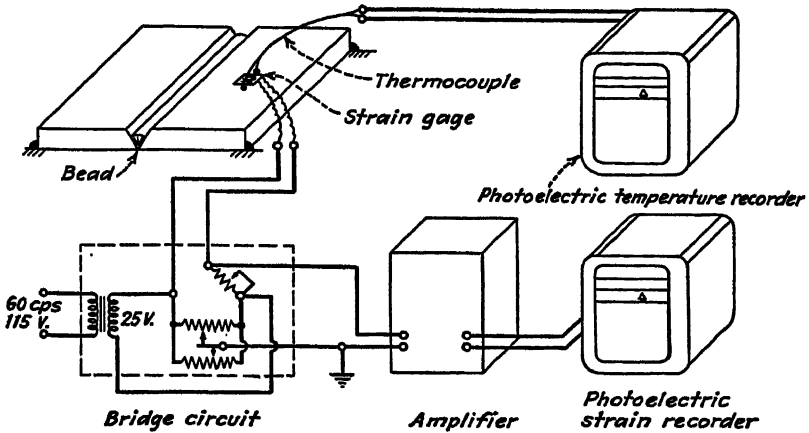

Strain gage setup for studying strains associated with welding.

of groups of wires, usually twisted or braided together.

stray capacitance Capacitance existing between circuit wires or parts and the metal chassis of electronic apparatus.

stray currents Currents wandering away from the rails of an electric railway system and traveling through the earth. Such currents are liable to cause damage by electrolysis of buried metal objects such as water pipes.

stray field Leakage magnetic flux that spreads outward from an inductor and does no useful work.

strays Electromagnetic disturbances that affect reception but are not produced by radio transmitting systems.

streamers Indefinite wavy bands occurring when the gas pressure in a discharge tube is reduced below the value required for a glow discharge through the tube.

stress Any force causing distortion of the shape of an object.

striated discharge An electrical discharge characterized by a luminous region consisting of alternate light and dark bands in the positive column adjacent to the anode of a glow tube.

striking an arc Starting an electric arc by touching the electrodes together momentarily.

striking potential 1. The voltage required to start an electric arc. 2. In a gas-filled triode, the smallest grid-cathode potential value at which plate current begins flowing.

string electrometer An electrometer (electrostatic voltage-measuring instrument) consisting of a conducting fiber stretched midway between two conducting plates parallel to the fiber. The electrostatic field between the plates displaces the fiber laterally in proportion to the voltage between the plates.

string galvanometer A galvanometer in which current to be measured is sent through a wire located in a strong magnetic field. The displacement of the wire is a measure of the current. Also called *Winthoven galvanometer*.

Stroboglow A stroboscope employing a neon tube energized at a controllable rate by a vacuum-tube oscillator to produce the desired intermittent illumination.

stroboscope An instrument that creates the optical illusion of slowing down or stopping motion of an object by illuminating it with flashes of intense light at regular intervals.

stroboscopic direction finder A direction finder employing a continuously rotating antenna system feeding neon tubes through amplifiers in such a way

STROBOSCOPIC PATTERN WHEEL

that a calibrated disk is illuminated momentarily at the position corresponding to the bearing of the received signal.

stroboscopic pattern wheel A printed disk having a number of rings, each with a different number of dark segments. When the pattern is placed on a rotating shaft and illuminated at a known frequency by a flashing discharge tube, the speed can readily be determined by noting which pattern appears to stand still or rotate slowly.

stroboscopic tachometer A stroboscope having a scale that reads in flashes per minute, or in revolutions per minute. The speed of a rotating device is measured by directing the stroboscopic lamp on the device, adjusting the flashing rate until the device appears to be stationary, then reading the speed directly on the scale of the instrument.



Strobotron tube.

Strobotron A type of glow lamp used to produce intensely bright flashes of light when fed with accurately timed voltage pulses. Used in electronic stroboscopes for visual inspection of high-speed moving parts.

strontium A metallic element sometimes used on cathodes of phototubes to obtain maximum response to ultraviolet radiation.

Strowger automatic telephone system A switching system characterized by the use of successive step-by-step selector switches actuated by current impulses produced by rotation of a telephone dial. The selectors are electromagnetically operated and contain a number of tiers of fixed contacts with each tier arranged in a semicircle. A moving

contact arm first rises to the height of the desired tier, then swings around horizontally and stops over the required contact.

ST station A studio-to-transmitter radio station, generally a low-power ultrahigh-frequency transmitter used to relay programs from the studio to the main transmitter.

stub A shorted or open impedance path between the two conductors of a transmission line. Generally adjustable as to position and used to match the impedance of an antenna or transmitter to that of a transmission line.

styli Plural of stylus.

stylus The specially shaped needle used in a sound recorder to cut or emboss the record grooves. Generally made of sapphire, Stellite, or steel. The plural is styli.

stylus drag The effect of friction between the surface of a record groove and the reproducing stylus of a phonograph pickup.

stylus force The effective weight or force acting in a vertical direction on the stylus of a sound recorder.

subaqueous loudspeaker An electromagnetic driving unit used to apply vibration to the human body in order to test or measure the sound transmission of body tissue.

subatomic Smaller in size than atoms, as electrons or protons.

subcarrier In facsimile, an intermediate wave that is modulated by the facsimile signals and in turn is used to modulate the main carrier, either alone or in conjunction with subcarriers on other channels.

subcarrier frequency modulation Frequency modulation employing a subcarrier.

subharmonic Any sinusoidal quantity having a frequency that is an integral submultiple of the frequency of the alternating current or signal to which it is referred. Thus, a third subharmonic would be one-third the fundamental frequency.

SUPERMITRON CAMERA

subject copy The material in graphic form that is to be transmitted for facsimile reproduction.

submarine cable A cable laid under water for telegraph, telephone, or power purposes. Gutta-percha insulation is usually employed, sometimes with an outer protective armor of steel.

submultiple resonance Resonance at a frequency that is a submultiple of the frequency of the exciting impulses.

substation Any building or outdoor location at which electric energy in a power system is transformed, converted, or controlled.

substitution method A method of measuring an unknown quantity in a circuit by first measuring or observing some circuit effect dependent on that quantity, then substituting in the circuit a similar but measurable value and adjusting it to produce a like effect. The unknown value is then assumed to be equal to the adjusted known value.

subsynchronous Having a frequency that is a submultiple of the driving frequency.

sudden ionospheric disturbance A sudden increase of ionization density in low parts of the ionosphere caused by a bright solar eruption. It usually lasts a few minutes, causing a sudden increase in absorption of radio waves and sometimes also causing simultaneous disturbances in earth currents and the earth's magnetic field.

sulphating Formation of lead sulphate on the plates of lead-acid storage bat-

teries, reducing the energy-storing ability of the battery and eventually causing failure.

sulphuric acid A compound of sulphur, hydrogen, and oxygen, having the chemical formula H_2SO_4 . Used as the electrolyte in lead-acid storage batteries.

SUP Generally used on circuit diagrams to denote the suppressor grid of a vacuum tube.

super Sometimes used as an abbreviation of superheterodyne.

superaudible Having a frequency above the range of audio frequencies (above approximately 20,000 cycles).

superaudio frequency A frequency above that of audible sound and hence above approximately 20,000 cycles.

superconductivity When certain metals are cooled to a sufficiently low temperature, their resistance drops to a very low value and the conductivity increases correspondingly.

superemitron camera A modification of the emitron television camera (British) in which greater sensitivity is obtained by separating the function of charge storage from that of photoelectric emission. An optical image is projected on a continuous photosensitive screen, and the electron emission from the back of this screen is focused electromagnetically onto a mosaic screen that is scanned by an electron beam as in the original emitron cathode-ray tube.

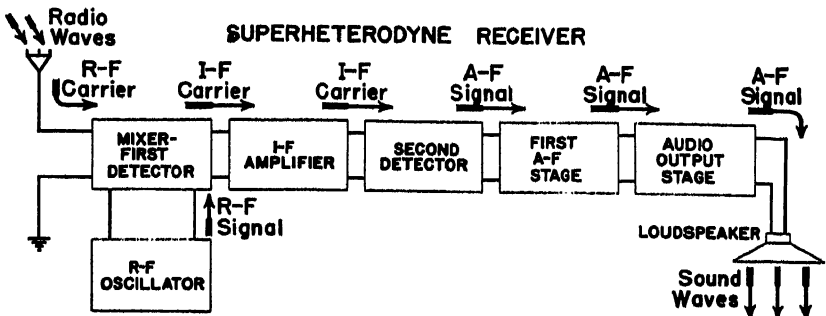

Block diagram of typical superheterodyne receiver.

SUPERHET

superhet Popular name for a superheterodyne circuit or a superheterodyne receiver.

superheterodyne receiver A radio receiver employing superheterodyne reception.

superheterodyne reception A method of receiving radio waves in which the process of heterodyne reception is used to convert the voltage of the received wave into a voltage of an intermediate frequency. This is done by combining the output of a local radio-frequency oscillator with the received signals in such a way as to produce the desired heterodyne or beat frequency. The intermediate frequency is then amplified and detected.

superhigh frequency A frequency in the band extending from 3,000 to 30,000 megacycles in the radio spectrum. Federal Communications Commission designations for the entire radio spectrum are:

vlf	10 to 30 kilocycles
l-f	30 to 300 kilocycles
m-f	300 to 3,000 kilocycles
h-f	3 to 30 megacycles
vhf	30 to 300 megacycles
uhf	300 to 3,000 megacycles
shf	3,000 to 30,000 megacycles

superimposed Superposed.

superposed Placed over or above. Same as superimposed.

superposed circuit An additional channel obtained from one or more circuits normally provided for other channels, in such a manner that all the channels can be used simultaneously without mutual interference.

superposition theorem The current that flows at a point in a linear network during simultaneous application of a number of voltages throughout the network is the sum of the component currents at the point that would be caused by the individual voltages acting separately. Likewise, the potential difference between any two points under such conditions is the sum of the component potential differences that would be produced between these two

points by the individual voltages acting separately.

superpower station A broadcast station employing extremely high power, of the order of 1,000,000 watts.

superregeneration The type of detection employed in a superregenerative detector.

superregenerative detector A vacuum-tube detector circuit that oscillates continuously at the frequency being received. The oscillation is broken up or quenched at a frequency slightly above the upper audibility limit of the human ear by a separate oscillator circuit connected between the grid and plate of the tube, to prevent the regeneration from exceeding the maximum useful amount. Advantages are extreme sensitivity, simplicity, and a minimum number of tubes and parts. Disadvantages are broadness of tuning (poor selectivity) and radiation that can cause interference in other receivers.

superregenerative receiver A tuned-radio-frequency receiver employing a superregenerative detector.

supersensitive relay A term sometimes applied to relays that operate on extremely small currents, less than about 250 microamperes.

supersonic Having a frequency above that of audible sound, hence above about 20,000 cycles. Also called *ultrasonic*. Frequencies below audibility (below about 15 cycles) are called *infrasonic*.

supersonic communication Communication through water by manually keying the sound output of echo ranging equipment used on ships.

supersonic light valve The heart of the Scophony system of television, consisting essentially of a quartz crystal placed in the center of a container filled with a liquid such as carbon tetrachloride. The crystal is excited at a high frequency, in the neighborhood of 10 megacycles, in such a way that compressive waves are set up in the liquid and make the liquid act

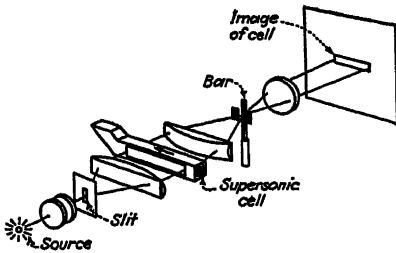

Use of supersonic cell as a light valve in the Scophony projection-television system.

somewhat like a diffraction grating. Light projected through the cell produces a series of fine illuminated lines on the screen. When the crystal is modulated also with video frequencies, these lines are broken up into light and dark picture elements constituting the reproduced image. In this system, several hundred picture elements are projected simultaneously, whereas in cathode-ray systems only one element is projected at a time.

supersonic sounding A system of determining ocean depth by measuring the time interval between the production of a supersonic wave just below the surface of the water and the arrival of the echo reflected from the bottom of the ocean. In modern apparatus, either magnetostriction or piezoelectric units are used for transmitting and receiving the sounds, and electronic equipment is employed to provide a continuous indication of depth, sometimes with a continuous recording.

supersonic therapy The employment of vibrations ranging from about 10,000 to 500,000 cycles for medical treatment.

supertonic Supersonic.

supervisory control A system for the selective control and automatic indication of the operation of remotely located units by electrical means, over a relatively small number of common transmission lines. Carrier current channels on power lines are commonly employed for this purpose.

supply Source of voltage.

suppressed carrier transmission That system of carrier transmission in which

the carrier component of the modulated wave is suppressed, only the side frequencies being transmitted.

suppressed-zero instrument An instrument in which the scale starts at some value considerably higher than zero, with a retarding force sufficient to hold the moving system and pointer against the zero stop until the quantity being measured attains the lowest printed value on the scale. It is equivalent to using a meter over only the upper part of its range and permits spreading this upper part over the entire scale.

suppression Elimination of any component of an emission, as a particular frequency or group of frequencies in an audio- or radio-frequency signal.

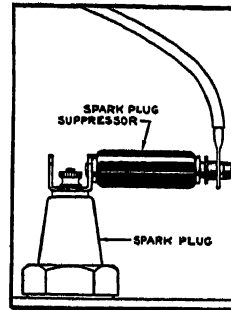

Suppressor.

suppressor A resistor having special terminals permitting convenient insertion in series with the spark-plug leads or distributor lead of an automobile engine or other internal-combustion engine to suppress spark interference that might otherwise interfere with radio reception.

suppressor grid A grid interposed between two electrodes (usually the screen grid and plate), both of which are positive with respect to the cathode, in order to prevent the passing of secondary electrons from one to the other. The suppressor grid is usually connected to the cathode.

surface analyzer An instrument that measures or records irregularities in a surface by moving the stylus of a crystal pickup or similar device over the surface, amplifying the resulting

SURFACE LEAKAGE

voltage, and feeding the output voltage to an indicator or recorder that shows the surface irregularities magnified as much as 50,000 times.

surface leakage The passage of current over the boundary surfaces of an insulator rather than through its volume.

surface noise Noise components in the output of a phonograph pickup due to rough particles in the phonograph record material or to irregularities left in the walls and bottom of the record grooves by the cutting stylus. Also called *needle scratch*.

surface resistivity The electric resistance of the surface of an insulator, measured between the opposite sides of a square centimeter of the surface.

surge A sudden and momentary variation in the current and/or potential at a point in a circuit, such as that due to sudden application of voltage to a circuit. An oscillatory surge includes both positive and negative polarity values. A surge having unidirectional polarity is called an impulse.

surge admittance The reciprocal of surge impedance.

surge generator An electric apparatus suitable for the production of high-voltage surges used for testing insulators and for other purposes. Also called *impulse generator*, and sometimes popularly known as *lightning generator*.

surge impedance The impedance in ohms measured between the terminals of a transmission line at the operating frequency. Also called *characteristic impedance*.

surge recorder An instrument for recording surges such as those due to lightning. It may have quick-acting relays that start or increase the speed of the recording chart or film as soon as a disturbance begins. Examples are the klydonograph and certain types of cathode-ray oscillographs.

susceptance For a portion of a circuit having a sinusoidal current and potential difference of the same frequency, susceptance is the ratio of the effective

current to the effective potential difference multiplied by the sine of the angular phase difference between these values. Susceptance is measured in mhos and is the reciprocal of reactance.

susceptibility 1. The susceptibility of a material, for a given value of the magnetizing force, is equal to the difference between its permeability and the permeability of a vacuum, divided by 4π times the permeability of a vacuum. Since the permeability μ of a vacuum is 1 in centimeter-gram-second electromagnetic units, the susceptibility in these units is $(\mu - 1)/4\pi$. 2. In a dielectric, the polarization per unit electric intensity.

suspension A fine wire or filament that supports the moving coil of a galvanometer or similar instrument.

suspension light valve A thin cell consisting essentially of extremely small particles suspended in a solution enclosed in a flat thin chamber of transparent material placed against the face of a cathode-ray tube. The action of the scanning beam varies the transparency of each elemental area of the cell in accordance with picture signal intensity in a television receiver, so that a light beam projected through the cathode-ray tube and light valve produces the received image on a screen.

sustained oscillation Oscillation in which forces outside the system, but controlled by the system, maintain a periodic oscillation of the system at a period or frequency that is very nearly the natural period of the system. A pendulum actuated by a clock mechanism is an example.

sustaining program A radio program that has no commercial sponsor.

SW Abbreviation for switch. Used chiefly on diagrams.

s-w Abbreviation for short-wave.

sweep circuit A vacuum-tube oscillator circuit that generates a voltage having a saw-tooth wave form suitable for application to a pair of deflecting plates in a cathode-ray tube, in order to make

the electron beam sweep back and forth across the fluorescent screen.

sweep oscillator An oscillator used to deflect periodically the electron beam of a cathode-ray tube so as to give a displacement that is a function of time.

sweep voltage The periodically varying voltage produced by a sweep oscillator and applied to the deflecting plates of a cathode-ray tube to give a displacement that is a function of time.

swinging A momentary variation in the frequency of a received radio wave.

swinging arm A type of mounting and feed used to move the cutting head at a uniform rate across the recording disk in some sound recorders. All phonograph pickups are of the swinging-arm type.

swinging choke An iron-core choke coil having a specially designed core that can be operated almost at magnetic saturation. The inductance of the coil then varies or swings when the average current value through the coil changes. Often used as the input choke in the filter system of a power pack to provide improved voltage regulation.

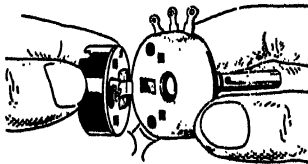

Switch cover being attached to volume control.

switch A device for completing, interrupting, or changing the connections in an electric circuit.

switchboard A single large panel or an assembly of panels on which are mounted switches, circuit breakers, meters, fuses, and terminals essential to the operation of electrical equipment.

SWL Abbreviation for short-wave listener.

symbol A design, letter, or abbreviation used on diagrams and maps, in

formulas, etc., to represent specific characteristics, quantities, or objects. Radio parts are often represented by schematic symbols on circuit diagrams.

symmetrical Balanced and hence having equal characteristics on each side of a central line, position, or value.

symmetrical transducer A transducer of which the image impedances are equal.

synchro The universal term applied to any of the various synchronous devices such as the selsyn, Autosyn, motor-torque generator, mag-slip, and Siemens. Theoretically, a synchro device is treated as a salient-pole bipolar alternating-current excited synchronous machine. The standard signal and control synchro today has a two-pole single-phase rotor field and a Y-wound single-phase variable-voltage stator. The transmitter of a synchro, whose rotor is geared to or otherwise linked with mechanical equipment, is also called a generator, synchro-generator, or selsyn generator. The indicator, also called a motor, synchro-motor, or selsyn motor, has a motor that is free to rotate and is damped to prevent excessive oscillation before coming into correspondence with the rotor of a transmitter.

synchro-generator The transmitter or generator in a synchro system. Its rotor is geared to or otherwise linked with some sort of mechanical equipment.

synchro-motor The indicator unit of a synchro. It has a rotor that is free to rotate and is damped to prevent excessive oscillation before coming into correspondence with the rotor of the transmitter. Also called *selsyn motor*.

synchronism 1. The condition in which the phase difference between two or more periodic quantities is zero, so that the speed of an alternating-current machine bears a definite and unchanging relation to its frequency or so that the operating speeds of two machines are alike. 2. The condition in which receiving and transmitting devices in a television, facsimile, print-

SYNCHRONIZATION

ing telegraph, or other similar system are operating at the same speed and in a similar manner.

synchronization The maintaining of one operation in step with another.

synchronizing In facsimile, the maintenance of predetermined speed relations between the scanner and the recorder within each scanning line.

synchronizing of images Maintaining the correct time and thus space relations between parts of the reproduced pictures in a television system.

synchronizing pulse One of the pulses added to the video output signal of a television camera for the purpose of synchronizing television receivers with the transmitter.

synchronizing relay A relay that functions when two alternating-current sources are in agreement within predetermined limits of phase angle and frequency.

synchronizing separator The television receiver circuit that separates the control impulses from video signals. Also called *amplitude separator* or *clipper*.

synchronizing signals Special signals sent out by a television transmitter between successive lines and between successive fields to keep the scanning motions of television receivers in step with that at the transmitter.

synchronoscope An instrument used to determine the phase difference or degree of synchronism of two alternating-current generators or two alternating-current quantities.

synchronous In step or in phase. Running at the same speed as some associated machine.

synchronous capacitor A rotating machine running without mechanical load, and so designed that its field excitation may be varied in order to draw a leading current (like a capacitor) and thereby modify the power factor of the alternating-current system or influence the load voltage through such change in power factor.

synchronous clock An electric clock driven by a synchronous motor, for operation on an alternating-current power system in which the frequency is accurately controlled.

synchronous converter A synchronous machine (with speed directly proportional to frequency) that converts alternating current to direct current, or vice versa. The armature winding is connected both to collector rings and to a commutator.

synchronous generator An alternating-current machine that transforms mechanical power into electric power and operates at a speed that is exactly proportional to the frequency of the generated alternating voltage. It may be a single-phase or polyphase synchronous generator. Also called *alternator*.

synchronous machine A machine in which the average speed of normal operation is exactly proportional to the frequency of the system to which it is connected.

synchronous motor A synchronous machine that transforms electric power from an alternating-current system into mechanical power. Direct current is generally required for field excitation and is usually supplied by an exciter.

synchronous rectifier A rectifier in which contacts are opened and closed at correct instants of time either by a synchronous vibrator or by a commutator driven by a synchronous motor.

synchronous speed The speed value related to the frequency of an alternating-current power line and the number of poles in the rotating equipment. Synchronous speed in revolutions per minute is equal to the frequency in cycles divided by the number of poles, with the result multiplied by 120.

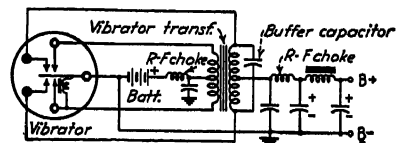

Synchronous vibrator circuit.

SYSTEM OF UNITS

synchronous vibrator An electromagnetic vibrator that simultaneously converts a low direct voltage to a low alternating voltage and rectifies a high alternating voltage obtained from a power transformer to which the low alternating voltage is applied. In power packs, it eliminates the need for a rectifier tube.

synchro system A system obtaining remote indication or control by means of self-synchronizing motors such as selsyns and equivalent types.

sync-signal generator A synchronizing signal generator for a television receiver or transmitter.

syntony The condition in which two oscillating circuits have the same resonant frequency.

system of units An assemblage of units for measuring physical quantities. It is complete if it is applicable to the measurement of all known physical quantities. Examples are the centimeter-gram-second system and the meter-kilogram-second system.

T

T Generally used on circuit diagrams to denote a transformer.

Ta Chemical symbol for tantalum.

table-model receiver A radio receiver having a cabinet of suitably small size for use on a table.

tachometer An instrument for measuring angular speed in revolutions per minute.

tachygraph A recording tachometer.

tail In facsimile, the excessive prolongation of the decay of the signal-wave tail. Also called *hangover*.

talker echo Echo that reaches the ear of the talker in a radio or telephone communication system.

talking radio beacon A radio beacon whose impulses are synchronized with audible sounds, so that distance can be estimated from the time between reception of the radio signal and the sound signal.

talk-listen switch A switch provided on intercommunication units to permit using the loudspeaker as a microphone when desired.

tangent galvanometer A galvanometer consisting of a small compass mounted horizontally in the center of a large vertical coil of wire. The current through the coil is proportional to the tangent of the angle of deflection of the compass needle.

tangential component A component acting at right angles to a radius.

tangential wave path A path of propagation tangential to the surface of the earth, for a direct radio wave. This path is curved by atmospheric refraction.

tank A gas-discharge tube with a pool-type cathode (liquid or solid) in which

no means is provided for controlling the unidirectional current flow. Used for rectification. Called a tank because it often has a metal envelope somewhat resembling a metal tank. Also called *pool tube*.

tank circuit A parallel resonant circuit, consisting of an inductor and a capacitor in parallel, one of which is usually variable.

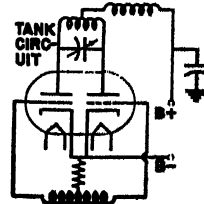

Tank circuit in an oscillator.

tantalum detector A detector consisting of the tip of a fine tantalum wire just touching the surface of a pool of mercury.

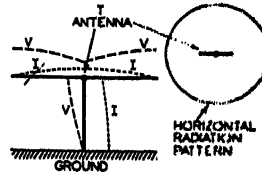

T antenna construction, voltage and current characteristics, and horizontal radiation pattern.

T antenna An antenna consisting of one or more horizontal wires, with the lead-in connection being made at the approximate center.

tap A connection made at some point along a resistor or coil other than at the ends.

taper The manner in which resistance is distributed throughout the element of a potentiometer or rheostat. Uniform distribution, having the same

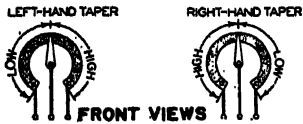
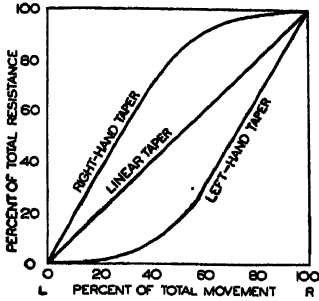

(SHAFT EXTENDS OUT OF THE PAPER)

Taper curves for volume controls, and method of identifying taper on actual controls by measuring resistance to the midposition when shaft of control points upward.

resistance per unit length throughout the element, is called linear taper. Nonuniform distribution is called non-linear taper.

tape transmitter A code-transmitting machine that is actuated by previously punched paper tape. Used for high-speed sending because the tape can be fed through the machine considerably faster than it was originally cut.

tapped control A rheostat or potentiometer having a fixed tap at some point along the resistance element, usually to provide a fixed grid bias or for automatic bass compensation.

tapped resistor A wire-wound fixed resistor having one or more additional terminals along its length, generally for voltage-divider applications.

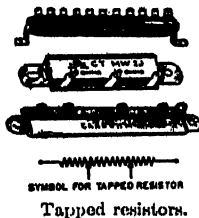

tap switch A multi-contact switch, used chiefly for connecting a load to any one of a number of taps on a resistor or coil.

target 1. An electrode or part of an electrode on which the stream of elec-

trons from the cathode of an X-ray tube is focused and from which X rays are emitted. It is usually made from platinum or tungsten and is operated at a high positive potential with respect to the cathode. Also called the *anode* or *anticathode*. 2. The electron-collecting electrode in a Farnsworth dissector tube for a television camera. 3. An object capable of reflecting radar or sonar pulses.

tasimeter An instrument for measuring temperature differences by means of the pressure exerted on the equivalent of a carbon microphone by a hard rubber strip that expands as temperature increases.

Taylor connection A transformer connection for converting three-phase power to two-phase power, or vice versa.

telautograph A writing telegraph instrument, in which movement of a pencil in the transmitting apparatus varies the current in two circuits in such a way as to cause corresponding movement of a pen at the remote receiving instrument. Also called *telewriter*.

telautography Transmission of images by telegraphic means over wires or by radio.

telemmeter A telometer that measures current.

telecamera A television camera, used to convert scenes into corresponding electrical impulses.

telecast A television program, or the act of broadcasting a television program.

telescine projector A motion-picture projector and associated equipment employed for televising motion-picture film.

telecommunication Transmission of messages and other information by wire or radio telegraphy, telephony, television, or other means.

telecord A type of phonograph recorder that can be connected to a telephone.

electrograph A system of phototelegraphy in which the original subject

TELECTROSCOPE

copy is composed of lines on a metal base, prepared by photography through a single screen of parallel lines. A metal stylus moving over the plate makes contact with the metal base only in regions corresponding to dark areas of the picture, so that current flows for dark portions. At the receiver, this current makes a colored mark by electrolytic action on paper moving synchronously.

telectroscope A television apparatus designed by Senlecq in 1877.

telegraph 1. Any system of conveying messages over a distance by means of signals. The term originally applied to semaphore and other visual systems but is now used chiefly for electrical systems. 2. The electrical or mechanical apparatus employed on a ship for conveying orders from the bridge to the engine room and other parts of the vessel. 3. To send a message over a telegraph system.

telegraph channel A path suitable for the transmission of telegraph signals between two telegraph stations, either over wires or by radio. It may be a one-way channel providing transmission in one direction only or a two-way channel providing transmission in both directions. Three basic types of channels are used to provide a number of telegraph channels on a single wire or radio circuit: (1) channels for simultaneous transmission in the same frequency range, as in bridge duplex, differential duplex, and quadruplex telegraphy; (2) channels for simultaneous transmission in different frequency ranges, as in carrier telegraphy; (3) channels for successive transmission, as in multiplex or varioplex printing telegraphy.

telegraph circuit The complete circuit over which signal currents flow between transmitting and receiving apparatus in a telegraph system. It sometimes consists of an overhead wire or cable and a return path through the ground.

telegraph distributor A device that effectively associates one direct current or carrier telegraph channel in rapid succession with the elements of one

or more signal-sending or receiving devices.

telegraph key A hand-operated telegraph transmitter, used to form telegraph signals.

telegraph-modulated waves Waves obtained by varying the amplitude or frequency of continuous waves by means of telegraphic keying.

telegraph repeater A type of relay inserted at intervals in long telegraph lines to detect faint or distorted messages and retransmit them automatically in clearer form over the next section of the line.

telegraph sounder A telegraph receiving instrument that converts Morse code signals into sounds that can be interpreted by noting the intervals of time between sounds.

telegraph transmitter A device for controlling a source for electric power so as to form telegraph signals for radio or wire transmission. It may be a telegraph key or a motor-driven sender using punched tape.

telegraphic type setting Remote control of a typesetting or typecasting machine through the medium of a telegraph line, sometimes directly and sometimes with the intermediary of a perforated paper tape.

telegraphone 1. Electrical apparatus for recording sound on a moving steel wire, tape, or disk by varying the magnetization, with subsequent reproduction by passing the magnetized material through pickup coils connected to a telephone receiver or to an amplifier and loudspeaker. The initial magnetization is produced by sending audio-frequency currents through iron-core coils positioned on either side of the moving steel material. 2. Apparatus that automatically records the number of a caller at the called station when there is no one at the called station to answer.

telegraphy Communication at a distance by means of code signals consisting of current impulses of varying length and spacing, these impulses

being sent to a distant point by electrical or other means, with or without connecting wires.

telehor An early form of television apparatus for small pictures, designed by Mihaly in 1922.

telemeter The complete measuring, transmitting, and receiving apparatus for indicating, recording, or integrating the value of a quantity at a distance by electric translating means.

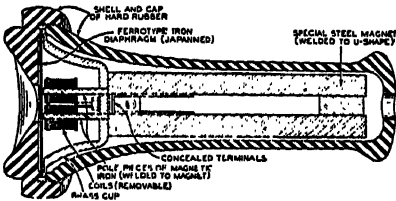

Cross-section of typical telephone receiver.

telephone An apparatus for converting sound waves of the human voice into variations that can be sent over wires and reproduced at a distant point to give the original sounds with sufficient accuracy for clear intelligibility of spoken words. The original telephone developed by Reis in 1869 was limited to the reproduction of musical sounds. Intelligible speech was first transmitted by Bell's instrument in 1876.

telephone capacitor A small fixed capacitor connected in parallel with a telephone receiver to bypass higher audio frequencies and thereby reduce noise.

telephone carrier current A carrier current used for telephone communication over power lines or to obtain more than one channel on a single pair of wires.

telephone channel A path suitable for the transmission of voice-controlled electric waves between two stations. It may be a one-way channel providing transmission in one direction only or a two-way channel providing transmission in both directions.

telephone circuit The complete circuit over which audio and signaling currents travel in a telephone system between the two telephone subscribers in communication with each other.

The circuit usually consists of insulated conductors, as ground returns are now rarely used in telephony.

telephone current An electric current produced or controlled by the operation of a telephone transmitter.

telephone jack The receptacle on a telephone or telegraph switchboard, having several contact springs behind the board for performing switching operations and making connections to the various parts of the plug that is inserted in the jack.

telephone line The conductors extending between telephone subscriber stations and central offices or between central offices, or the conductors and circuit apparatus associated with a particular telephone communication channel.

telephone receiver

That part of a telephone set which converts the current variations received over a telephone line into sound waves corresponding to the words spoken into the telephone transmitter elsewhere in the telephone system.

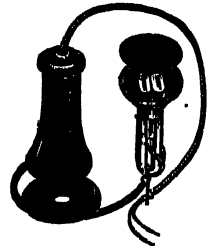

Telephone receiver.

telephone repeater A vacuum-tube amplifier inserted at one or more intermediate points in a long telephone line to maintain the required current strength. Repeaters permit using lighter weight copper line wires and reduce or eliminate the amount of inductive loading required.

telephone set An assemblage of apparatus including a telephone transmitter, a telephone receiver and usually

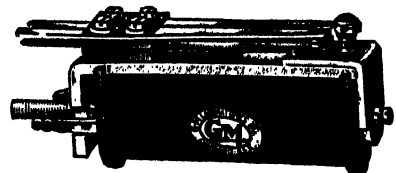

Telephone relay, widely used in electronic circuits as well as telephone circuits.

TELEPHONE STATION

a switch, along with the associated wiring and signaling arrangements for the use of these instruments in telephony.

telephone station An installed telephone set with associated wiring and apparatus, in service for telephone communication.

telephone switchboard A switchboard for interconnecting telephone lines and associated circuits.

telephone transmitter The microphone in a telephone system, at which the sound waves of spoken words are converted into corresponding electric currents.

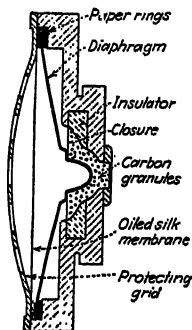

Telephone transmitter used in modern handsets.

telephonograph Equipment for recording on a phonograph a message received by telephone.

telephony Measurements and tests of telephone circuits and apparatus.

telephony Reproduction of spoken words or other sounds at a distant point by electrical or other means, with or without connecting wires.

telephoto Early television apparatus employing tuning-fork controlled vibrating mirrors acting on the scanning beam at the transmitter.

telephoto Transmission of photographs or other single images over a telegraph system by scanning the picture into elemental areas in orderly sequence, converting each area into a proportional electric signal, transmitting the signals in sequence, and reassembling them in correct order at the receiver. Also called *facsimile*, *phototelegraphy*, *wirephoto*, etc.

telephotography Reproduction of photographs or other pictures at a distance by means of radio or wire communication. Usually shortened to telephoto.

telephoto lens A lens system that is physically shorter than its rated focal length, used in ordinary and television cameras to secure large images of objects at comparatively great distances.

teletypewriter A simplified form of teletypewriter system using a typewriter keyboard instrument for transmission and a motor-driven tape printer for receiving.

telethermometer An apparatus for indicating or recording temperature values at a distance.

Teletician Trade-mark name applied to a person who has received training from National Radio Institute in the servicing of television equipment.

Teletype Trade-mark of Teletype Corp. for a kind of typewriter.

Teletypesetter Trade-mark of Teletype Corp. Apparatus for setting and casting type directly in response to received telegraph signals.

teletypewriter A printing telegraph instrument having a keyboard similar to that of a typewriter for use in sending messages, and having motor-driven signal-actuated mechanisms for printing received messages directly.

television To watch a scene by means of a television system.

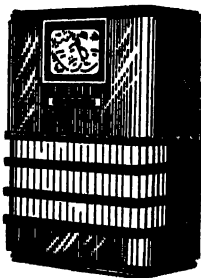

Television set.

television The electric transmission and reception, either over wires or by radio, of transient visual images in such a way as to give a substantially continuous and simultaneous reproduction to the eye at a distance.

TELEVISION CAMERA

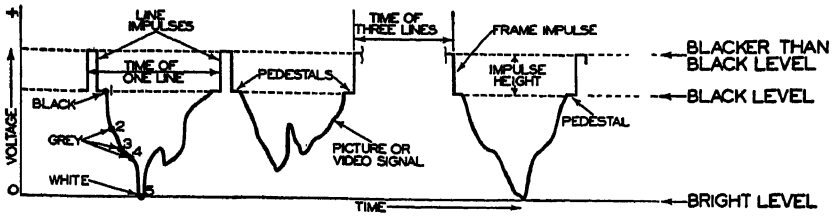

Essential components of a television signal.

television broadcast band The several groups of channels, each containing a number of 6-megacycle channels, that are available for assignment to television broadcast stations.

television broadcast station A station licensed for the transmission of visual



Television studio, showing camera, overhead microphone, and lights.

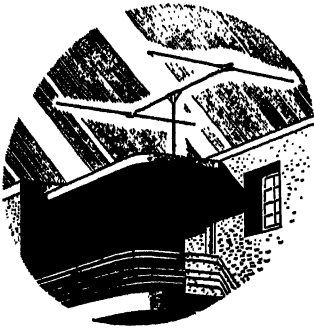

Television receiving dipole antenna with reflector.

images of moving or fixed objects and the associated sound, for reception by the general public.

television camera The pickup unit used in a television system to convert into

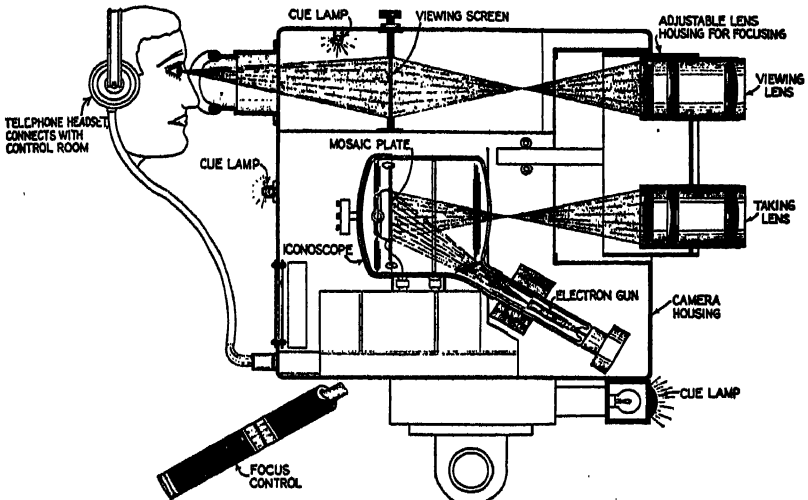

Construction of one type of television camera.

TELEVISION CHANNEL

electrical signals the optical image formed by a lens.

television channel A band of frequencies 6 megacycles (6,000 kilocycles) wide, available for assignment to a single television broadcast station

television connection Terminals provided at the input of the audio-frequency amplifier in an ordinary radio receiver to permit using the receiver to reproduce the sound portion of a television program. The audio-frequency signal is obtained from a television receiver having no audio-frequency channel.

television engineering That phase of radio engineering which deals with the theory and practice of transmitting television programs and accompanying sound through space and receiving such programs with appropriate equipment.

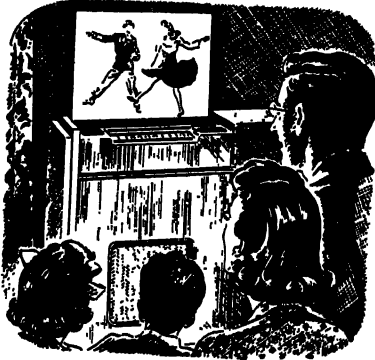

Large-screen projection television receiver for home use.

television receiver A receiver having complete channels for receiving the television picture and its associated sound. Standards established by Radio Manufacturers Association (RMA) specify that a set receiving pictures only must be called a picture receiver.

television transmitter The radio transmitter or transmitters used for the transmission of both the visual (picture) and aural (sound) signals of a television program. A visual transmitter transmits the visual signal only, while an aural transmitter transmits the aural signals only.

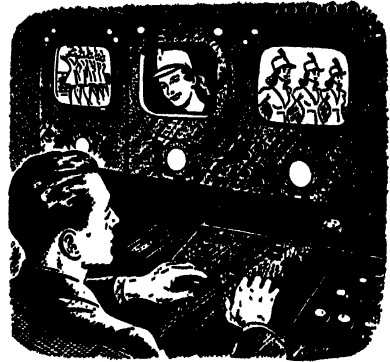

Monitor control desk at a television station.

televisor Early name for the apparatus used in a mechanical television system for scanning the object or scene being transmitted.

televoltmeter A telemeter that measures voltage.

telewattmeter A telemeter that measures power.

teletwriter A telautograph unit.

telex An audio-frequency teleprinter system used in Great Britain to provide teletypewriter service over telephone lines.

temperature coefficient The increase or decrease of a quantity that is affected by temperature, owing to a unit change of temperature.

temperature coefficient of resistance A factor equal to the amount that a 1-ohm piece of material increases in resistance for each degree of rise in temperature above 0° centigrade. Its value is about 0.00427 ohm for copper.

temperature-compensating capacitor A capacitor whose capacitance varies with temperature in a known and predictable manner, used extensively in oscillator circuits to compensate for changes in the values of other parts with temperature.

temperature control A switch actuated by a thermostat responsive to changes in temperature, used to maintain temperature within certain limits.

temperature detector Any instrument that may be used to measure the temperature of a body. It may employ any physical property that is dependent on temperature, such as differential expansion of two bodies, the voltage developed at the junction of two metals, the change of resistance of a metal, or radiation from a hot body.

temperature radiator A body whose production of radiant energy is determined by its temperature and the material and character of its surface, and is independent of its previous history.

temperature relay A relay that functions when temperature rises to a predetermined value in the apparatus it protects.

temperature saturation The condition in which the plate current of a thermionic vacuum tube cannot be further increased by increasing the filament voltage and hence cathode temperature at a given value of plate voltage. The effect is due to the space charge formed near the cathode. Also called *filament saturation*.

tension Synonym for voltage, as high-tension line.

terminal Any fitting attached to a circuit or device for convenience in making electrical connections.

terminal impedance The impedance as measured between the input or output terminals of an apparatus, as distinguished from the impedance of the transmission line that might be connected to the apparatus.

terminated line A transmission line terminated in a resistance equal to the

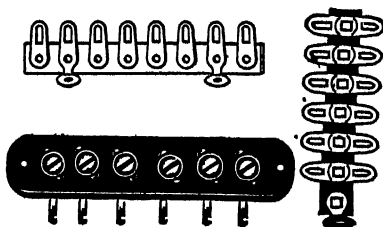

Terminal strips.



Terminal lug sequence for electrolytic capacitors. The blank ear used for reference is always between lugs 1 and 2, and has no hole in it. Numbering is clockwise looking at the base, the same as for tubes. Unwanted terminals are omitted, leaving a blank hole in the cover plate. All 1-inch diameter containers have the following marks to identify the voltage ratings of the various sections or, when voltage ratings are identical, to identify the capacitances of the sections:

- | | | |
|---------|---|-----------------------------|
| Singles | — | lug (No. 3) (— = Blank) |
| Duals | □ | lug (No. 1) highest voltage |
| | △ | lug (No. 2) lowest voltage |
| Triples | □ | lug (No. 1) highest voltage |
| | △ | lug (No. 2) medium voltage |
| | — | lug (No. 3) lowest voltage |

For 1 3/8-inch-diameter containers the following terminal lug sequence is used for highest voltage rating or highest capacitance:

- | | | |
|---------|---|-------------------------------|
| Singles | — | lug (No. 4) (— = Blank) |
| Duals | □ | lug (No. 1) highest voltage |
| | △ | lug (No. 3) lowest voltage |
| Triples | □ | lug (No. 1) highest voltage |
| | □ | lug (No. 2) medium voltage |
| | □ | lug (No. 3) lowest voltage |
| Quads | □ | lug (No. 1) highest voltage |
| | □ | lug (No. 2) next high voltage |
| | △ | lug (No. 3) next high voltage |
| | — | lug (No. 4) lowest voltage |

characteristic impedance of the line, so there is no reflection and no standing waves.

termination The load connected to the output end of a transmission line.

terrestrial magnetism Magnetism observable everywhere due to the fact that the earth itself is a permanent magnet, having its magnetic poles near the geographical poles.

tertiary winding A winding added to a transformer in addition to the conventional primary and secondary windings, such as for suppressing third harmonics or for making connections to a power-factor correcting device.

Tesla coil An air-core transformer having a few turns of heavy wire as primary and many turns of fine wire as secondary. The oscillatory discharge across a spark gap is applied to the primary, and the resulting extremely high value of high-frequency voltage across the secondary is capable of

TESLA CURRENT

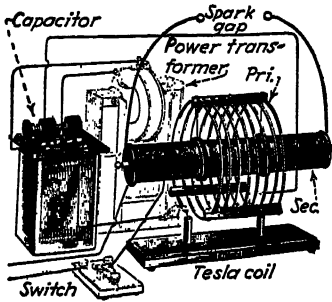

Tesla coil with associated apparatus.

producing a brush discharge between widely separated electrodes in air.

Tesla current A high-frequency current produced by a voltage that is fairly high but is intermediate between that for Oudin and D'Arsonval currents. Used in electrobiology.

Tesla transformer A Tesla coil.

test board A board or panel provided with the instruments, terminals, and equipment needed for testing a particular apparatus.

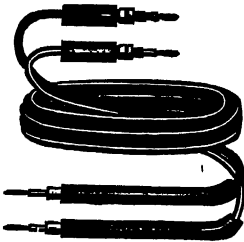

Test leads.

test lead A flexible insulated lead, usually with a test prod at one end, used for making tests, connecting instruments to a circuit temporarily, or making other temporary connections.

test oscillator A test instrument that can be set to generate an unmodulated or tone-modulated radio-frequency signal at any frequency needed for aligning or servicing radio receivers and amplifiers. Also called an *all-wave oscillator*, *all-wave signal generator*, *oscillator*, or *signal generator*.

test prod A metal point attached to an insulating handle and connected to a

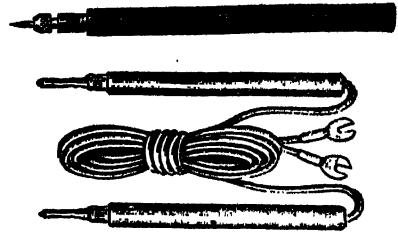

Test prod with phonograph needle tip, and conventional test prods with leads.

test lead for convenience in making a temporary connection to a terminal during tests.

test set A combination of instruments needed for making a particular combination of tests or for servicing a particular type of electrical equipment.

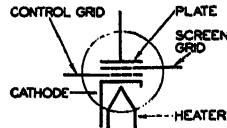

Tetrode symbol.

tetrode A four-electrode vacuum tube containing an anode, a cathode, a control electrode, and one additional electrode ordinarily in the nature of a grid.

TE wave A transverse electric wave, one of the two classes of waves that can be sent through wave guides. A *TE* wave possesses longitudinal magnetic force, with the electric vector everywhere perpendicular to the direction of wave propagation. The first subscript numeral following the letters gives the order of the wave, corresponding to the number of vibrations or half-period variations of the field along diameters of a circular wave guide or along the x coordinate of a rectangular guide. The second subscript numeral gives the mode of the wave, corresponding to the number of vibrations or half-period variations of the field in a radial direction between the center and the walls, counting the outermost (the wall or sheath) as one, or the number of vibrations along the y coordinate of a rectangular wave guide. *TE* waves are also called *H* waves, with the subscripts having the same signif-

icance. Thus, $TE_{0.1}$ and $H_{0.1}$ waves are identical.

Th Chemical symbol for thorium.

thalofide A composition of thallium, oxygen, and sulphur possessing photoconductive properties.

thalofide cell A photoconductive type of photoelectric cell in which the active light-sensitive material is thallium sulphide in a vacuum. It has maximum response at the red end of the visible spectrum.

theme The characteristic musical selection, sound, or message used to open and identify some radio programs.

thermal agitation Random movements of the free electrons in a material. In a conductor, they produce minute pulses of current. When these occur in the conductors of a resonant circuit at the input of a high-gain amplifier, the fluctuations are amplified together with signal currents and heard as noise.

thermal-agitation voltage The potential difference produced in circuits due to the agitation of the electrons in the conductors.

thermal ammeter An instrument in which current is measured by sending it through a fine wire, which is thereby heated. The resulting expansion or sag of the wire is used to deflect the meter pointer. It will measure either alternating current or direct current since both have the same heating effect. Also called *hot-wire ammeter*.

thermal cutout A protective device that automatically opens the circuit of an electric motor or other device when the operating temperature exceeds a safe value.

thermal detector A detector utilizing the heating effect of radio-frequency signals to cause detection, as in the barretter.

thermal flasher An electric device that opens and closes a circuit automatically at regular intervals owing to alternate heating and cooling of a bimetallic strip that is heated by a resistance

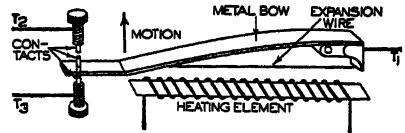

Thermal time-delay relay.

element in series with the circuit being controlled.

thermal instrument Any instrument that depends on the heating effect of an electric current, such as thermocouple instruments and hot-wire instruments.

thermal ionization Ionization due to high temperature, as in the electrically conducting gases of a Bunsen-burner flame.

thermal microphone A microphone depending for its action on the variation in the resistance of an electrically heated conductor that is being alternately increased and decreased in temperature by sound waves.

thermal radiation Radiation produced by the action of heat on molecules or atoms. Its frequency extends between the extremes of infrared and ultraviolet. Commonly known as *heat*.

thermal telephone receiver An electroacoustic transducer, such as a headphone or loudspeaker, in which the temperature of a conductor is caused to vary in response to the current input, producing sound waves as a result of the expansion and contraction of the adjacent air. Also called *thermophone*.

thermostat An electronic temperature-controlling system.

thermel A general term sometimes used to cover all forms of thermoelectric thermometers, including series of couples, thermopiles, and single thermocouples.

thermic Pertaining to heat.

thermion An electron or positive ion emitted from a heated body, as from the hot cathode of a thermionic vacuum tube.

thermionic Pertaining to emission of electrons by heat.

THERMIONIC AMPLIFIER

thermionic amplifier A circuit in which thermionic vacuum tubes are utilized to convert small voltage variations applied between the cathode and grid into large current variations in the plate circuit. It may have several successive stages of amplification, each with its own vacuum tube.

thermionic current Any current due to directed movements of thermions, such as the flow of emitted electrons from the cathode to the plate in a thermionic vacuum tube.

thermionic detector A detector circuit utilizing a thermionic vacuum tube to deliver an audio-frequency signal when fed with a modulated radio-frequency signal.

thermionic emission The emission of electrons from hot bodies. The rate of emission increases rapidly with temperature. Also known as *Edison effect* or *Richardson effect*.

thermionic instrument Any instrument utilizing the amplifying effect of one or more thermionic vacuum tubes.

thermionic rectifier A rectifier utilizing a thermionic vacuum tube to convert alternating current into unidirectional current.

thermionics That branch of physics dealing with phenomena due to emission of electrons by heat.

thermionic tube A vacuum tube in which one of the electrodes, invariably the cathode, is electrically heated, usually to incandescence, for the purpose of causing electron or ion emission from that electrode. Sometimes called *hot-cathode tube*.

thermionic valve British term for thermionic vacuum tube.

thermionic voltmeter A vacuum-tube voltmeter in which the voltage to be measured is applied between the grid and cathode of a vacuum tube and the resulting change in plate current is interpreted in terms of voltage.

thermionic work function The energy required to transfer electrons from a given metal to a vacuum or other

adjacent medium during thermionic emission.

thermistor A resistor whose value varies with temperature in a definite desired manner, used in circuits to compensate for temperature variations in other parts. It may have either a negative or a positive temperature coefficient. One type is made from a semiconducting material such as uranium oxide or silver sulphide, having a relatively large negative temperature coefficient of resistance. The name is a contraction of thermal resistor.

thermoammeter

An ammeter that is actuated by the voltage generated in a thermocouple through which is sent the current to be measured. Used chiefly for measuring radio-frequency currents.

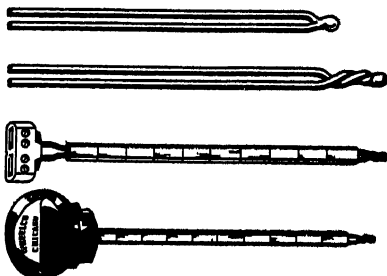
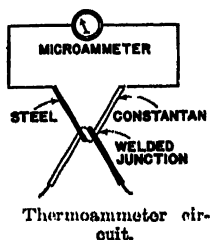

Examples of thermocouples.



Thermocouple tube.

thermocouple A pair of dissimilar metals in contact forming a thermojunction at which a voltage is developed when the junction is heated. Used for measuring temperature differences, because the thermoelectromotive force (voltage due to heat) is proportional to the difference in temperature between the thermojunction and the rest of the circuit.

thermocouple ammeter A thermoammeter.

thermocouple instrument A meter in which one or more thermojunctions are heated directly or indirectly by an electric current, thereby generating a direct current that is measured by a suitable direct-current mechanism.

thermoelectric effect Development of a voltage due to differences in temperature between two junctions of dissimilar metals in the same circuit. Discovered by J. T. Seebeck, German physicist, in 1821. Also called *Seebeck effect*.

thermoelectricity Electricity produced by direct action of heat, as by unequal heating of the two junctions in a circuit composed of two dissimilar metals.

thermoelectric generator A device for converting heat energy into electric energy by heating thermojunctions.

thermoelectric inversion When the temperature difference of a thermocouple is increased beyond a certain neutral point, the voltage decreases rather than increases and eventually reverses in polarity so as to cause reversal in the direction of the current.

thermoelectric junction A thermojunction, such as that in a thermocouple.

thermoelectric manometer A manometer (pressure-measuring instrument) that depends on the variation of thermoelectromotive force (voltage due to heat) with pressure.

thermoelectric power A term used to denote the voltage produced by a metal in contact with a standard metal, such as lead, for a difference in temperature of 1° centigrade between the junction and the rest of the circuit.

thermoelectric series A series of metals arranged in the order of their thermoelectric powers.

thermoelectromotive force The voltage developed due to differences in temperature between parts of a circuit containing two or more different metals. This voltage is produced by the Seebeck effect.

thermoelectron An electron emitted from a heated body. Sometimes called *thermion*.

thermoelement A thermocouple combined with a heating filament, used for measuring small currents.

thermogalvanometer An instrument for measuring small high-frequency currents by their heating effect, generally consisting of a direct-current galvanometer connected to a thermocouple that is heated by a filament carrying the current to be measured.

thermojunction The contact surface between two different metals in an electric circuit. When maintained at a different temperature from other parts of the circuit (from the other thermojunction formed by opposite ends of the different metals), the junction produces a voltage that is proportional to the difference in temperature, and this voltage can send current through the circuit. A thermojunction thus converts heat energy directly into electrical energy. Also called *thermoelectric junction*, and used in thermocouples.

thermomagnetic Pertaining to the effect of temperature on the magnetic properties of a substance, or to the effect of a magnetic field on the temperature distribution in a conductor.

thermometer An instrument for measuring temperature. Electrical versions depend on the change in resistance of a material with temperature, on the voltage produced in a thermocouple, and on various other effects of temperature.

thermophone An electroacoustic transducer, such as a telephone receiver, headphone, or loudspeaker, in which the temperature of a conductor is caused to vary in response to the current input, producing sound waves as a result of the expansion and contraction of the adjacent air. Also called *thermal telephone receiver*.

thermopile An apparatus for converting heat directly into electrical energy. It consists of a number of thermojunctions in series, with alternate junctions kept hot and cold, respectively. Experimental units utilizing a gas flame have generated sufficient power to operate a radio receiver.

THERMOPLASTIC MATERIAL

- thermoplastic material** A plastic material that can be softened by heat and rehardened into a solid state by cooling. It may be remelted and remolded many times. Examples are polystyrene, cellulose nitrate, cellulose acetate, vinyl copolymers, methyl-methacrylate, etc.
- thermorelay** A device for amplifying small galvanometer deflections. The galvanometer mirror reflects an intense beam of light on a sensitive thermocouple in such a way that slight deflections of the beam cause relatively large changes in temperature at the thermojunction. A second galvanometer connected across the thermocouple shows deflections many times greater than those of the first galvanometer.
- thermosetting material** A plastic material that under application of heat and pressure will polymerize into a hard, infusible product. It will not soften to any extent on reheating and cannot be remelted or remolded. Examples are urea aldehydes, phenol aldehydes, cresol aldehydes, etc.
- thermostat** An automatic device for maintaining essentially constant temperature or detecting changes in temperature. It may utilize a bimetallic strip, liquid or gas-filled bellows, or any other temperature-sensitive arrangement to close contacts and produce the required correction or action.
- thermostat relay** A type of temperature relay that receives its operating energy in the form of heat conducted from the device being protected. It functions when temperature reaches a predetermined value.
- Thévenin's electrical theorem** If an impedance Z' is connected between any two points in a circuit at which there exists a voltage e and an impedance Z initially between the points, the current through the added impedance Z' will be equal to the voltage e divided by the sum of Z and Z' .
- thickness vibration** Vibration of a piezoelectric crystal in the direction of its thickness.
- third harmonic** A sine-wave component having three times the fundamental frequency of a complex wave.
- Thomas precession** The precession of the spin axis of an electron due to the acceleration given to the electron by the electric field of the nucleus.
- Thomson balance** Kelvin balance. William Thomson later became Lord Kelvin; hence his developments are known by either name.
- Thomson coefficient** The ratio of the voltage existing between two points on a metallic conductor to the difference in temperature of those points.
- Thomson effect** When a current flows from a warm to a cooler portion of a conductor, or vice versa, heat is liberated or absorbed depending on the material of which the conductor is made.
- Thomson electromotive force** The voltage that exists between two points that are at different temperatures in a conductor. Studied by William Thomson (Lord Kelvin), British scientist.
- Thomson-Whiddington-Bohr law** The depth to which cathode electrons penetrate the target of an X-ray tube is V^2/b , in which V is the target-cathode voltage and b is a constant dependent on the target material and other factors.
- thoriated emitter** A thoriated filament.
- thoriated filament** A vacuum-tube filament consisting of tungsten mixed with a small quantity of thorium to give improved electron emission.
- thorium** A metal that emits electrons liberally when heated. Sometimes incorporated in tungsten filaments of vacuum tubes to form an emitting layer of thorium at the surface of the filament.
- thorium series** One of the principal radioactive series beginning with thorium.
- thorn needle** A type of soft playback point or phonograph needle similar to a cactus or fiber needle.
- thoron** The gaseous radioactive product formed by the expulsion of an alpha particle from thorium X.

thread The material removed from a phonograph disk by the recording stylus during sound recording. Also called *chip*.

three-phase current Current delivered through three wires, with each wire serving as the return for the other two and with the three current components differing in phase successively by one-third cycle or 120 electrical degrees.

three-phase four-wire system An alternating-current supply system comprising three conductors connected as in a three-phase three-wire system, and a fourth conductor connected to the neutral point of the supply, which may be grounded.

three-phase three-wire system An alternating-current supply system comprising three conductors. The alternating voltages of successive pairs of conductors differ in phase by 120 electrical degrees.

three-pole switch An arrangement of three single-pole switches coupled together to open three circuits simultaneously.

three-wire system A direct-current or single-phase alternating-current system comprising three conductors, one of which (the neutral wire) is maintained at a potential midway between the potential of the other two. Part of the load may be connected between the outer conductors, the remainder being divided as evenly as possible into two parts, each of which is connected between the neutral and an outer conductor. Two voltages are available, one being twice the other.

threshold The point at which an effect is first produced, observable, or otherwise indicated.

threshold frequency The frequency at which the quantum energy is just sufficient to release photoelectrons from a given surface. Also called *critical frequency*.

threshold of audibility The loudness level at which sound at a particular frequency can barely be heard. Also called *threshold of hearing*.

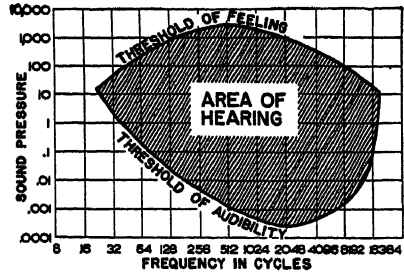

Threshold of audibility for average human ear. Shaded region is area of hearing.

threshold of feeling The loudness level at which sound at a particular frequency can barely be felt.

threshold of hearing The threshold of audibility.

throat That end of a horn having the smaller cross-sectional area.



Throat microphones in use by aviator.

throat microphone A contact microphone that is strapped to the throat of a speaker and reacts to throat vibrations directly rather than to the sound waves they produce.

throwing power A measure of the adaptability of an electrolytic solution to deposit metals uniformly on a cathode of irregular shape during electroplating.

throw-out spiral A blank spiral groove of large pitch at the end of a phonograph record, provided to actuate the

THUMP

record-changing mechanism of an automatic record changer.

thump The noise heard in a receiver connected to a telephone circuit on which a direct-current telegraph channel is superposed, caused by the telegraph currents.

Thury regulator An automatic voltage regulator in which the controlling shaft of the field rheostat is rotated in either direction by a pair of solenoids operating pawls acting on a ratchet wheel mounted on the shaft. The solenoids are so actuated by the generator output voltage that this voltage is maintained essentially constant despite variations in load.

thyatron A hot-cathode gas-discharge tube in which one or more electrodes are employed to control electrostatically (with grids) the starting of the unidirectional current flow. Used as controlled rectifiers to supply variable direct voltage or current from an alternating-current source, as inverters to supply alternating-current power from a direct-current supply, as frequency changers, and as contractors for electronic switches that close a circuit for a definite number of cycles in welding.

thyatron inverter An inverter circuit employing thyatron tubes to convert direct-current power to alternating-current power.

thyatron stroboscope A special thyatron tube used to provide intense flashes of light suddenly and periodically by discharging a capacitor across the tube at intervals controlled by the grid voltage. Used as a stroboscope for study of moving objects and measurement of their frequency or speed.

Thyrite A silicon-carbide ceramic material having nonlinear resistance characteristics. Above a critical voltage, the resistance falls considerably. Used in lightning arresters, for protective and stabilizing purposes in electronic circuits, for control purposes, and for voltage dividers in which division of voltage is to be independent of load current.

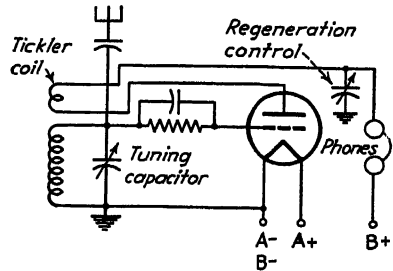

Tickler coil in regenerative detector used as high-frequency receiver.

tickler A small coil connected in series with the plate circuit of a vacuum tube and inductively coupled to a grid-circuit coil for the purpose of providing feedback. Used chiefly in regenerative detector circuits.

tie-down point One of the frequencies at which a radio receiver is aligned. For the broadcast band, the tie-down points are usually 600 and 1,400 kilocycles.

tie point An insulated terminal to which two or more wires may be anchored for support.

tier array An array of antenna elements, one above the other.

tie wire A wire used to connect a number of terminals.

tight coupling Closest possible coupling between two radio-frequency circuits under given conditions, permitting minimum magnetic leakage.

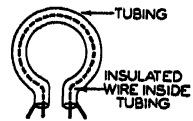
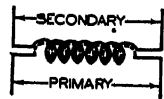

tilting 1. The forward inclination of the wave front of radio waves traveling along the ground. Its value depends on the electrical constants of the

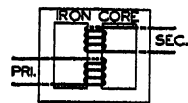

Examples of tight-coupling methods.

2. Changing the angle of a television camera to follow a moving object being televised.

time constant The time required for an exponential quantity to change by an amount equal to 0.632 times the total change that will occur. In a capacitor-resistor circuit, it is the number of seconds required for the capacitor to reach 63.2 per cent of its full charge after a voltage is applied. In an inductor-resistor circuit, it is the number of seconds required for the current to reach 63.2 per cent of its final value. The time constant of an inductor having an inductance L in henrys and resistance R in ohms is L/R . The time constant of a capacitor having a capacitance C in farads in series with a resistance R in ohms is RC .

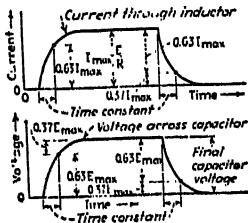

Time constant curves for an inductor (above) and a capacitor (below).

time-delay circuit A circuit that delays the transmission of an impulse a definite desired period of time.

time-delay relay A relay in which there is an appreciable interval of time between energizing of the coil and movement of the armature or between deenergizing of the coil and movement of the armature. Examples are quick-acting relays, slow-acting relays, and slow-release relays.

time lag The interval of time between application of any force and full attainment of the resultant effect.

time phase Reaching corresponding peak values at the same instants of time, though not necessarily at the same points in space.

time quadrature Differing by a time interval corresponding to one-fourth the time of one cycle of the frequency in question.

timer A special clock mechanism or motor-operated device used to perform switching operations at predetermined intervals of time.

time signals Time-controlled radio signals broadcast at regular intervals each day on a number of different frequencies by government-operated radio stations.

time switch A clock-controlled switch used to open or close a circuit at one or more predetermined times.

timing axis oscillator An oscillator circuit that generates a saw-tooth voltage for the horizontal deflecting plates or horizontal deflecting coils of a cathode-ray tube, an oscilloscope, or other instrument. It makes the spot on the screen retrace its path many times per second so as to produce a stationary image.

tinned wire Copper wire that has been coated during manufacture with a layer of tin or solder to prevent corrosion and simplify soldering of connections.

tinsel cord A highly flexible cord used for headphone leads, test leads, etc., in which the conductors are strips of thin metal, foil, or tinsel wound around a strong but flexible central cord.

tip The contacting part at the end of a telephone-type plug.

tip jack A small single-hole jack into which fits a single-pin contact plug. Also called *pup jack*.

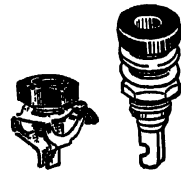

Tip jacks.

Tirrell regulator An automatic voltage regulator in which a vibrating-contact device short-circuits the shunt rheostat of a generator intermittently in accordance with the actions of relays responsive to the voltage being regulated, so as to maintain constant output voltage during load variations. In effect, it varies the average value of field resistance by varying the interval of time that this resistance is short-circuited.

T-M

t-m Abbreviation for time modulation (pulse-time modulation). Same abbreviation used for noun and adjective.

TM wave A transverse magnetic wave, one of the two classes of waves that can be sent through wave guides. A *TM* wave possesses longitudinal electric force, with the magnetic vector everywhere perpendicular to the direction of wave propagation. Subscript numerals have the same significance as for *TE* waves. *TM* waves are also called *E* waves. Thus, *TM*_{0,1} and *E*_{0,1} waves are identical.

T network A network composed of three impedance branches connected in star, so that one end of each branch is connected to a common point, while the three remaining ends are connected to an input terminal, an output terminal, and a common input and output terminal, respectively.

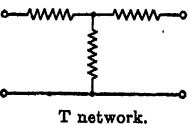

Toepler-Holtz machine A type of static machine used for charging Leyden jars and producing sparks, consisting of fixed and rotating glass disks bearing pieces of tin foil. There are two sets of brushes and the usual collector.

toggle switch Any small switch that is operated by manipulation of a projecting lever.

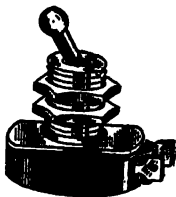

Toggle switch.

toll line A telephone line or channel between two central offices in different exchanges.

tone 1. A musical sound. 2. An audible note produced by the flow of single-frequency alternating current through headphones or a loudspeaker. 3. The quality or general character of a reproduced radio program as it affects the human ear.

tone control A control sometimes provided in a radio receiver and audio-frequency apparatus to permit changing the frequency response so as to

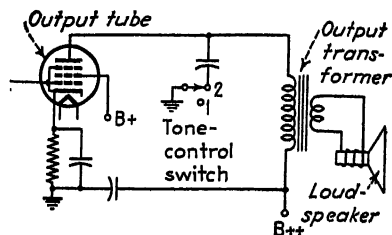

Simple tone-control switch as used in the output stage of a radio receiver.

secure a proportion of bass to treble that is pleasing to a particular listener. In effect, a tone control attenuates either low or high audio frequencies a controllable amount to change the over-all frequency response.

tone generator Any device for providing an audio-frequency current suitable for signaling purposes or for testing audio-frequency equipment.

tone-modulated waves Waves obtained by modulating continuous waves at a single audio frequency in a substantially periodic manner.

tone wheel A rotating apparatus used in radiotelegraphy for converting incoming continuous waves to audio-frequency beats that can be reproduced as audible sounds. A high-speed interrupter, consisting of a contact brush pressing against a wheel having many fine teeth separated by insulating material, is driven at such speed that the frequency of the interruptions differs slightly from that of the incoming radio waves, producing the required beat frequency.

top cap A vacuum-tube terminal in the form of a metal cap positioned at the top of the tube and connected to one of the electrodes, usually the control grid.

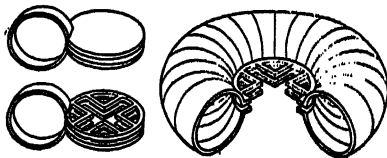

Development of toroid cavity resonator, by cutting holes in a two-plate capacitor and placing single-turn coils around the edges.

toroid A doughnut-shaped coil, such as that formed by bringing together the ends of a coil spring.

torsiometer An instrument for measuring the amount of power being transmitted by a rotating shaft. Electrical versions depend on observation of the very small twisting of the shaft, proportional to the load on the shaft, or on twisting of components of a coupling device inserted between sections of the shaft.

torsion galvanometer A galvanometer in which the force between the fixed and moving systems is measured by the angle through which the supporting head of the moving system must be rotated to bring the moving system back to its zero position.

torsion pendulum A pendulum weight suspended by a wire. The wire and pendulum rotate due to torsion (twisting) of the wire.

torsion-string galvanometer A sensitive galvanometer in which the moving system is suspended by two parallel fibers that tend to twist around each other.

total luminous flux The total light emitted by a light source in all directions.

tourmaline A strongly piezoelectric natural crystal.

tower A tall metal structure used as a transmitting antenna, or used with another such structure to support a transmitting antenna wire.

tower radiator A tall metal structure used as a transmitting antenna.

Townsend characteristic The current-voltage characteristic curve for a phototube at constant illumination and at voltages below the glow potential.

Townsend discharge An electrical discharge in a gas at moderate pressure (above about 0.1 millimeter of mercury). It is free of space charges. Sometimes called *corona discharge*.

T pad A pad made up of resistance elements arranged as a T network (two resistors inserted in one line, with a

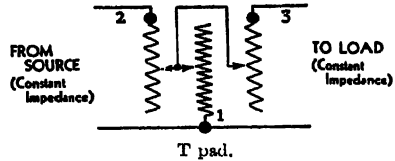

third between their junction and the other line).

tracer A thread of contrasting color woven into the insulation of a wire for identification purposes.

tracking 1. The condition in which all tuned circuits in a receiver accurately follow the frequency indicated by the tuning dial over the entire tuning range. 2. The condition in which phonograph pickup stylus follows the record grooves without jumping out into adjacent grooves.

traffic Messages handled by communication stations or by amateur stations.

transadmittance The alternating component of the current at one electrode divided by the alternating component of the voltage at another electrode, all other electrode voltages being maintained constant.

transceiver A combination of radio transmitting and receiving equipment in a single housing, generally for portable or mobile applications. Some or all of the vacuum-tube stages and other circuit components are used for both transmitting and receiving, by employment of suitable switching arrangements.

transconductance The amplification factor of a vacuum tube divided by the alternating-current plate resistance. More generally, it is the inphase component of the alternating current of one electrode divided by the alternating voltage of another electrode, all other electrode voltages being maintained constant. The control grid-plate transconductance is ordinarily the most important, and is commonly understood to be intended when either of these terms is used. Also called *mutual conductance*.

transcribe To record, as to record a radio program by means of electrical transcription for future rebroadcasting.

TRANSCRIPTION

transcription An electrical transcription, such as a high-fidelity 33½ revolution-per-minute record containing part or all of a radio program. It may be either an instantaneous recording disk or a pressing.

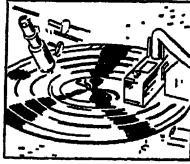

Transcription turntable using vertical recording system.

transducer A device by means of which energy may flow from one or more transmission systems to one or more other transmission systems. The energy may be of any form, such as electrical, mechanical, or acoustical. A passive transducer contains no source of power, while an active transducer contains one or more sources of power. A loudspeaker is a transducer that changes electrical energy into acoustical energy. A phonograph pickup is a transducer that changes mechanical energy into electrical energy.

transducing piezoid A piezoid (finished crystal blank) used as a transducer rather than as a resonator or oscillator.

transfer admittance The complex ratio, with respect to two pairs of terminals of an electrical transducer at a specified frequency, of the current at the second pair of terminals to the electromotive force applied between the first pair of terminals, all pairs of terminals being terminated in any specified manner.

transfer characteristic The relation between the voltage of one electrode and the current to another electrode, all other voltages being maintained constant. Usually shown by a graph.

transfer constant For an electric transducer (energy-transferring device), the arithmetic mean of the natural logarithm of the ratio of input to output voltages and the natural logarithm of the ratio of input to output currents when the transducer is terminated in its image impedances. For a symmetrical transducer, the transfer constant is the same as the propagation constant. The real part of the transfer constant is the image attenuation con-

stant, and the imaginary part is the image phase constant.

transfer factor The transfer ratio.

transfer impedance In connection with any two pairs of terminals of a network, the ratio of the voltage applied at one pair of terminals to the resultant current at the other pair of terminals, when all terminals are terminated in any specified manner.

transfer ratio The ratio, with respect to two points in a wave, of the displacement at the second point to that at the first point. It is expressed as a vector involving both amplitude and phase angle. The magnitude of this vector is called the attenuation ratio. Also called *propagation factor*, *propagation ratio*, or *transfer factor*.

transformation period The time required for the activity of a radioactive substance to decay to half its value.

transformer An electric device, without continuously moving parts, that transfers electric energy from one or more circuits to one or more circuits by electromagnetic induction without change in frequency but usually with changed values of voltage and current.

transformer oil A high-quality insulating oil in which windings of large power transformers are sometimes immersed to provide high dielectric strength, high insulation resistance, high flash point, freedom from moisture, and freedom from oxidization.

transformer kiosk A small aboveground chamber used for large transformers in power systems.

transient A temporary component of current existing when a circuit is adjusting itself to a new load or new source voltage.

transient oscillation A momentary oscillation occurring in a circuit during switching.

transient phenomena Rapidly changing actions occurring in a circuit during the interval between closing of a switch and settling to steady-state conditions,

or any other temporary actions occurring after some change in a circuit.

transition factor The ratio of the load current that would be delivered by a particular generator to a particular load without matching to the load current obtained when generator and load impedances are matched. Also called *mismatching factor* or *reflection factor*.

transition frequency In sound recording, the frequency at which a change-over occurs from constant-amplitude recording (at higher audio frequencies) to constant-velocity recording (at lower audio frequencies).

transition point A point at which the constants of a circuit change in such a way as to cause reflection of a wave being propagated along the circuit.

transitron oscillator A vacuum-tube oscillator using a resistor and capacitor in its feedback circuit, and capable of generating audio frequencies or serving as a frequency-selective amplifier.

transit time The time required for an electron to travel from one electrode to another in a vacuum tube.

translucent Partly transparent, permitting some passage of light yet not providing clear visibility.

transmission 1. The transfer of electric power from one location to another over conductors. 2. Dispatching of a signal, message, or other form of intelligence by means of wire or radio-telegraphy, telephony, or facsimile.

transmission gain A general term used to indicate an increase in the power of a signal during transmission from one point to another. Transmission gain is generally obtained with vacuum-tube amplifiers and is usually expressed in decibels.

transmission level The ratio of the signal power at any point in a transmission system to the signal power at some point in the system chosen as a reference point, usually expressed in decibels.



Twisted-pair transmission line.

transmission line A set of conductors used to transfer signal energy from one location to another, or to transmit current over long distances for power purposes.

transmission loss A general term, frequently abbreviated as simply loss, used to denote a decrease in power during transmission from one point to another. It is usually expressed in decibels. Transmission loss may be used as a synonym for insertion loss when the terminating impedance is specified.

transmission plane The plane of vibration of polarized light that will pass through a Nicol prism or other polarizer.

transmission unit An early signal level unit now known as the decibel.

transmittance The fraction of radiant energy entering a layer of a medium which reaches its further boundary.

transmitter 1. The equipment used for generating and amplifying a radio-frequency signal, modulating this carrier signal with intelligence, and radiating the modulated radio-frequency carrier into space as radio waves. 2. In telephony, the carbon microphone that converts sound waves into audio-frequency signals. 3. The generator unit of a synchro system. It is a larger and higher wattage unit than the indicator, and its rotor is geared to or otherwise linked with some sort of mechanical equipment. Also called *helixyn generator* or *synchro-generator*.

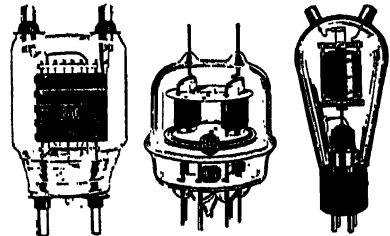

Transmitting tubes.

TRANSMITTING STATION

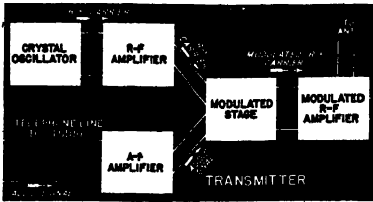

Main sections of a broadcast transmitter.

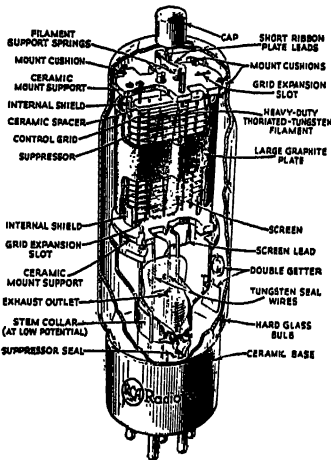

Transmitting pentode tube (type 803).

transmitting station The location at which the transmitter, transmitting antenna, and associated transmitting equipment of a radio system are grouped.

transmutation Changing one chemical element into another.

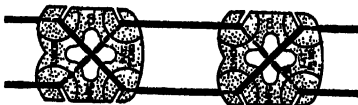

Transposition blocks.

transposition Interchanging the relative positions of wires to neutralize the effects of induction to or from other circuits or, in two-wire parallel leadins for an antenna, to minimize radiation from the leadin during transmission and to minimize interference pickup by the leadin during reception.

transrectification Rectification that occurs in one circuit when an alter-

nating voltage is applied to another circuit.

transrectification characteristic A graph obtained by plotting the direct voltage values for one electrode of a vacuum tube as abscissus against the average current values in the circuit of that electrode as ordinates, for various values of alternating voltage applied to another electrode as a parameter. The alternating voltage is held constant for each curve.

transrectification factor The change in the average current of an electrode divided by the change in the amplitude of the alternating sinusoidal voltage applied to another electrode. The direct voltages of these and other electrodes are maintained constant.

transrectifier A device, ordinarily a vacuum tube, in which rectification occurs in one electrode circuit when an alternating voltage is applied to another electrode.

transverse electric wave Any wave with the electric vector everywhere perpendicular to the direction of wave propagation. Abbreviated *TE* wave.

transverse electromagnetic wave An electromagnetic wave in which both electric and magnetic displacements are transverse to the direction of propagation.

transverse launching device A device for launching *H* waves from a coaxial cable into a circular wave guide. For

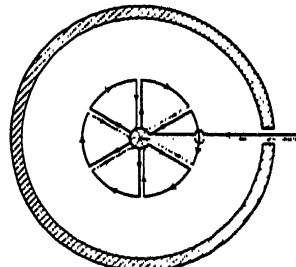

Transverse device for launching an H_{01} wave in a circular wave guide. Six wires bent into sector-shaped loop antennas radiate a field characteristic of this wave. The lines indicating the loops are drawn in varying thicknesses.

$H_{0,1}$ waves It consists of a number of wires bent into sector shape to form loop antennas connected in parallel. These are mounted in the center of the guide, with the transmission line running to them through a hole in the wall of the guide.

transverse magnetic wave Any wave with the magnetic vector everywhere perpendicular to the direction of wave propagation. Abbreviated *TM* wave.

transverse plate A plate of metal or highly resistant material, used to close the end of a wave guide or used as an adjustable piston inside the guide. When of metal, a transverse plate is an almost perfect reflector of electromagnetic waves. When of carbon or of glass with a sputtering of metal on one side, it gives partial reflection.

transverse wave A wave in which the direction of displacement at each point of the medium is perpendicular to the direction of propagation. When the displacement makes an acute angle with the direction of propagation, the wave is considered to have both longitudinal and transverse components.

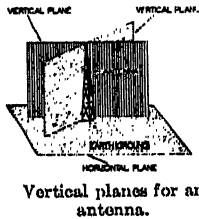

trautonium An electronic musical instrument in which audio-frequency currents are generated in an oscillator circuit employing a neon tube controlled by a variable resistance.

traveling wave A wave traveling in one direction.

treble The higher audio frequencies.

trf Abbreviation for tuned radio frequency.

triangulation Determination of the position of a ship or aircraft by obtaining bearings of the moving object with reference to two fixed radio stations a known distance apart. This gives the values of one side and all angles of a triangle, from which the position can be computed.

triboelectric Pertaining to electricity generated by friction.

trickle charge A continuous charge of a storage battery at a low rate approximately equal to the internal losses and suitable for maintaining the battery in a fully charged condition. This term is also applied to very low rates of charge capable of restoring intermittent discharges of small amount in addition to compensating for internal losses.

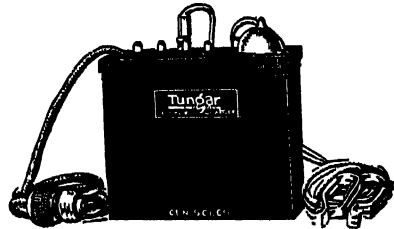

Trickle charger using a Tungar rectifier tube. The cord at the left goes to an a-c power line, and the clips at the right are placed on the terminals of the storage battery to be charged.

trickle charger A device designed to charge a storage battery at a low rate continuously to keep it fully charged.

triclinic A crystal structure having three unequal axes intersecting at angles, not more than two of which are equal and not more than one of which is 90 degrees.

trigger action Initiation of main current flow instantaneously by a weak controlling impulse in a device.

trigger circuit 1. A circuit in which one or more currents or voltages change abruptly from one stable value to another at a critical value of some voltage or resistance in the circuit and change abruptly back to the original values at a different critical value of the controlling voltage or resistance. 2. A vacuum-tube circuit consisting of one or more scaling couples, each of which produces one output pulse for each two input pulses. The tubes are fired alternately by the input pulses. Used in scaling circuits for counting pulse rates higher than can be handled by mechanical recorders.

TRIMMER CAPACITOR

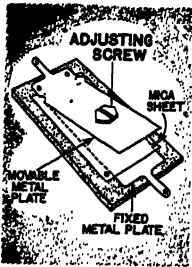

Trimmer capacitor.

trimmer capacitor A small variable capacitor used in tuning circuits of radio receivers and other equipment to adjust capacitance values during alignment so that all circuits can be tuned accurately by a single control.

triode A three-electrode vacuum tube containing an anode, a cathode, and a control electrode.

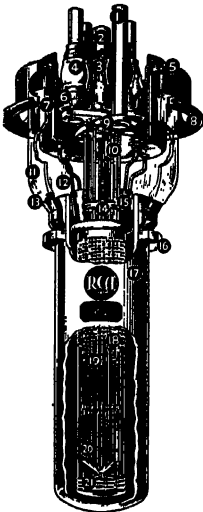

High-power triode, used as power output tube in 50-kilowatt and larger transmitters. Numbered parts are: 1. Filament posts; 2. Exhaust-tube protective cap; 3. Metal exhaust tube; 4. Filament lead seal (metal-to-glass); 5. Grid terminal; 6. Entrant metal header; 7. Grid seal (metal-to-glass); 8. Corona ring; 9. Filament terminal blocks; 10. Filament support rods; 11. Hard-glass bulb; 12. Grid support rods; 13. Anode seal (metal-to-glass); 14. Filament heat shield; 15. Electrostatic shield; 16. Anode flange; 17. Anode ($\frac{1}{4}$ -inch thick copper); 18. Grid welded to supports; 19. Tie wires for self-supporting filament assembly; 20. Filament strands; 21. Filament tie.

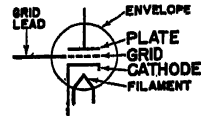

Triode tube.

triode-pentode A vacuum tube having a triode and a pentode in the same envelope.

trip coil An electromagnet having a moving armature arranged to trip a circuit breaker or other protective device and thereby open a circuit under abnormal conditions.

triplex system A telegraph system in which two messages in one direction and one message in the other direction can be sent simultaneously over a single circuit.

tripping device Any mechanical or electromagnetic device used to bring a circuit breaker or starter to its off or open position either when certain abnormal electrical conditions occur or when a catch is actuated manually.

tristimulus colorimeter An instrument that measures a color stimulus in terms of three selected stimuli called primaries. The ideal source-filter-photoelectric cell combination for a photoelectric tristimulus colorimeter is spectrally equivalent to the 1931 CIE standard observer for colorimetry, in combination with an appropriate light source.

tristimulus colorimetry Measurement and comparison of colors by means of three or more filter combinations of such spectral character that they duplicate the standard CIE observer for colorimetry. The filters transmit bands having a wide wavelength range. The application of photoelectric cells to the method now permits direct and rapid measurements.

tristimulus designation Specification of the amounts of the three primary stimuli required to produce a color match for an unknown color.

tri-tet oscillator A crystal-controlled vacuum-tube oscillator circuit in which the crystal circuit is isolated from the output circuit through use of the screen

grid electrode as the oscillator anode. Used for multiband operation because it generates strong harmonics of the crystal frequency.

tritium The hydrogen isotope having an atomic weight or mass of 3. It is one type of heavy hydrogen.

troposphere That part of the earth's atmosphere occupying a space above the surface of the earth up to a height of about 6 miles (10 kilometers) in which temperature generally decreases with altitude, clouds form, and convection is active.

tropospheric wave A radio wave that is propagated by reflection from a region of abrupt change in dielectric constant in the troposphere.

true bearing A bearing given in relation to true geographic north. A magnetic bearing is given in relation to the magnetic north, while a relative bearing is given in relation to the lubber line or other axis of an aircraft or vessel.

true ohm The actual value of the practical unit of resistance. It is equal to 10^9 absolute electromagnetic units. The international ohm is equal to about 1.00052 true ohms, because standards of resistance can be made only approximately equal to the true value.

true power The average value of power consumed by a circuit during one complete cycle of alternating current. Also called *active power*, *actual power*, or simply *power*, and measured in watts.

trunk A telephone line or channel between two central offices or switching devices, used to provide telephone connections between subscribers generally.

trunk hunting The automatic movement of a contact arm in a selector until it reaches a contact of an idle telephone line or circuit.

trunnion A cylindrical support for a bearing, used in some crystal phonograph pickups.

tube 1. A vacuum tube, so named because of its oftentimes tube-shaped

TUBE OF MAGNETIC INDUCTION

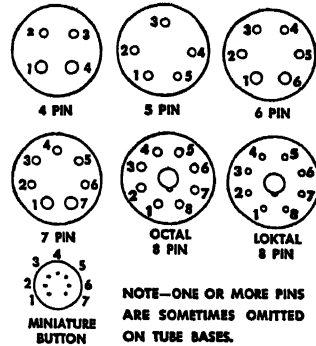

Standard tube base-pin numbering arrangement.

glass or metal envelope. 2. A hollow cylindrical piece of porcelain, usually unglazed, having a head or shoulder at one end. It is inserted in a hole drilled through a wall, floor, ceiling, joist, stud, etc., and electric wires are run through the tube.

tube coefficients The constants that describe the characteristics of a thermionic vacuum tube, such as amplification factor, mutual conductance, and alternating-current plate resistance.

tube counter A tubular form of ion counter.

tube electrometer A thermionic vacuum tube adapted for use as an electrometer for measuring electrostatic charges.

tube heating time In a mercury-vapor tube, the time required for the coolest portion of the tube to reach operating temperature.

tube noise Noise originating in a vacuum tube, such as that due to shot effect and thermal agitation.

tube of magnetic induction A magnetic circuit of tubular form having the same magnetic flux through all cross-sections.

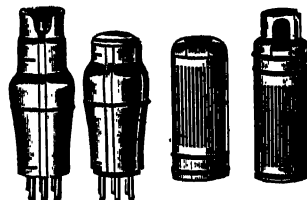

Tube shields.

TUBE TESTER

tube tester A test instrument designed to indicate the condition of vacuum tubes used in electronic equipment.

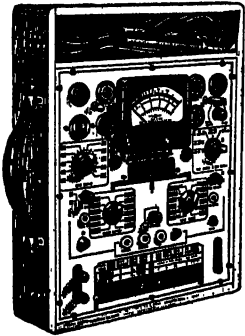

Combination emission-type tube tester and set tester.

tube voltage drop In a vacuum tube, the potential difference between anode and cathode.

tube voltmeter A voltage-measuring instrument utilizing the characteristics of a vacuum tube for measuring voltages with minimum effect on the circuit to which the instrument is connected. Also called *vacuum-tube voltmeter*.

tubular capacitor A paper or electrolytic capacitor having the form of a cylinder, with leads usually projecting axially from the ends. The capacitor plates are long strips of metal foil separated by insulating strips, all rolled together into a compact tubular shape.

tuned antenna An antenna designed to provide resonance at the desired operating frequency by means of its own inductance and capacitance.

tuned circuit A coil-capacitor circuit that can be preset or adjusted to resonance at a desired frequency.

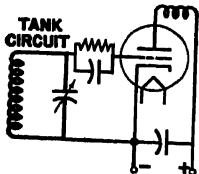

Tuned circuit serving as the tank circuit in a tuned grid-inductive plate oscillator.

tuned filter A parallel resonant circuit, a series resonant circuit, or any other arrangement used either to attenuate or to pass signals at the resonant frequency.

tuned-filter oscillator A vacuum-tube oscillator employing a tuned filter.

tuned grid-tuned plate oscillator A vacuum-tube oscillator having parallel resonant circuits in both grid and plate circuits, with both circuits tuned to the radio frequency it is desired to generate. The feedback essential for maintenance of oscillation is obtained by the plate-grid interelectrode capacitance of the tube.

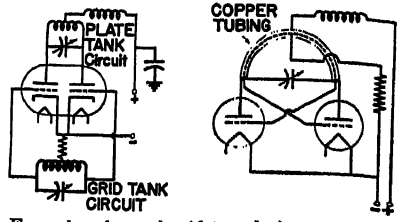

Examples of tuned grid-tuned plate-oscillator circuits.

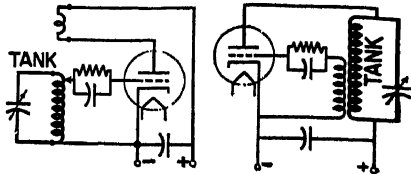

Tuned-grid oscillator circuit (left) and tuned plate oscillator circuit (right).

tuned radio-frequency amplifier An amplifier employing vacuum tubes and tuned circuits for the purposes of amplifying radio-frequency energy.

tuned radio-frequency receiver A radio receiver consisting of a number of vacuum-tube amplifier stages that are tuned to resonance at the carrier frequency of the desired signal by a gang variable tuning capacitor. The amplified signals at the original carrier frequency are fed directly into the detector for demodulation, and the resulting audio-frequency signals are amplified by an audio-frequency amplifier and reproduced by a loudspeaker.

tuned radio-frequency transformer A transformer used for coupling two radio-frequency amplifier stages.

tuned reed frequency meter A vibrating-reed instrument for measuring the frequency of an alternating current.

TUNGSTEN FILAMENT

tuned relay A relay having mechanical or other resonating arrangements that limit response to currents at one particular frequency.

tuned resonating cavity A resonating cavity half a wavelength long or some multiple of a half wavelength, used in connection with a wave guide to produce a resultant wave whose amplitude in the cavity greatly exceeds that of the wave in the guide. For reception of waves, a detecting grating can be placed at the point of maximum amplitude in the cavity, to convert the energy to a form suitable for amplification in a telephone or television circuit. A tuned cavity is a non-reflecting termination for a guide.

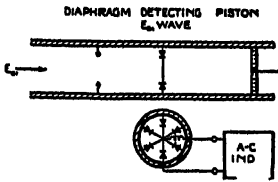

Tuned resonating cavity used as nonreflecting termination for cylindrical wave guide. Crystal detectors in the detecting grating convert the energy of the cavity into useful form. A cross-section view of the grating is shown below.

tuned transformer A transformer whose associated circuit elements are adjusted to be resonant at the frequency of the alternating current supplied to the primary, thereby causing the secondary voltage to build up to higher values than would otherwise be obtained.

tuner 1. A unit containing only the radio-frequency amplifier and detector stages of a receiver, used chiefly for feeding radio programs into the audio-frequency amplifier of a public-address or other sound system. 2. That portion of a receiver which contains the circuits that are tuned to resonance at the received signal frequency. 3. Any device for adjusting a resonant circuit to a particular frequency.

Tungar rectifier A vacuum-tube rectifier circuit employing a Tungar tube.

Tungar tube A phanotron (hot-cathode gas-discharge rectifier tube) having a

heated filament serving as cathode and a graphite disk serving as anode in an argon-filled bulb at a low pressure. Used chiefly in battery chargers.

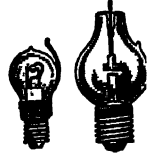

Tungar tubes.

tungsten A pure metal used for filaments and other electrodes of vacuum tubes, for the target in X-ray tubes, for electrodes of spark gaps, and for contacts of relays.

tungsten filament A filament used in incandescent lamps and in thermionic vacuum tubes and other tubes requiring an incandescent cathode. It is generally made by drawing tungsten metal into wire with dies. The fusing point of the tungsten is about 1700° centigrade. Smaller tungsten filaments are operated in a vacuum, while those for larger lamps are used in an inert gas at about ordinary atmospheric pressure.

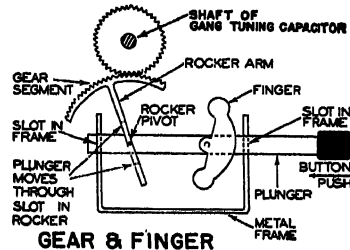

GEAR & FINGER

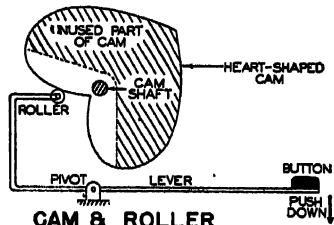

CAM & ROLLER

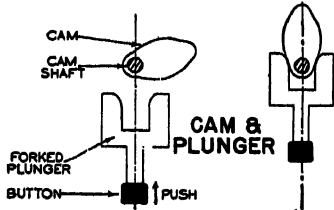

CAM & PLUNGER

Examples of mechanical automatic tuning systems.

TUNING

tuning 1. Adjusting the inductance or capacitance in a coil-capacitor circuit to obtain resonance at a desired frequency. 2. Adjusting all tuning circuits in a radio receiver or transmitter simultaneously for optimum performance at a desired frequency.

tuning capacitor A variable capacitor used to adjust the natural frequency of an oscillatory or resonant circuit.

tuning circuit A circuit containing inductance and capacitance, either or both of which may be adjusted to make the circuit responsive to a particular frequency.

tuning coil A variable inductor used to adjust the natural frequency of an oscillatory or resonant circuit.

tuning control The control knob that adjusts all tuned circuits of a receiver simultaneously for reception of a desired sound or television program.

tuning eye Popular name for a cathode-ray tuning indicator.



Tuning fork with electrical driving coil.

tuning fork A two-pronged hard steel device that vibrates at a definite natural frequency when struck or when set in motion by electromagnetic means. Used in some electronic equipment as an accurately controllable source of signals because its vibrations can be transformed readily into audio-frequency signals by means of pickup coils.

tuning-fork drive Control of a vacuum-tube oscillator by continuous vibrations of a tuning fork. A high harmonic of the oscillating signal obtained from the fork is selected by filter circuits and strongly amplified to determine the frequency of the main oscillator in a radio transmitter.

tuning in Adjusting the tuning controls of a radio receiver to obtain maximum response to the signals of the station it is desired to receive.

tuning indicator

Any device that indicates when a radio receiver is tuned accurately to a radio station. It is connected to some circuit in which current or voltage is a maximum or minimum when the receiver is accurately tuned to give maximum output signal strength.



Meter-type tuning indicator.

tuning inductor

A variable inductor used for tuning purposes. In ultrahigh-frequency circuits, it may consist of one or more turns in series or in parallel, arranged near rotor plates that can be rotated between the turns to reduce the inductance by introducing short-circuited turns.

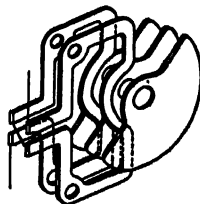

Tuning inductor for 260- to 350-megacycle circuit.

tuning meter An ordinary direct-current meter connected to a radio-receiver circuit for use in determining when the receiver is accurately tuned to a station. Now largely replaced by the cathode-ray tuning indicator.

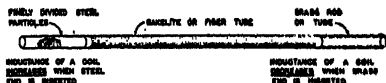

Construction of a tuning wand.

tuning wand A rod of insulating material having a brass plug at one end and a powdered iron core at the other end. Generally used for checking receiver alignment.

turbidimeter An instrument for measuring the turbidity of a liquid. A photoelectric turbidimeter does this by measuring the amount of light that passes through the liquid. Also called *opacimeter*.

turn One complete loop of wire.

turns ratio The ratio of the number of turns in a secondary winding of a transformer to the number of turns in the primary winding.

TWO-WIRE REPEATER

turnstile antenna

An ultrahigh-frequency antenna consisting of two halfwave dipoles at right angles to each other and crossing at their centers, fed with currents that are 90 degrees out of phase. Maximum energy is radiated perpendicular to the plane of the dipoles, but this up-and-down radiation for a horizontal turnstile can be overcome by stacking another turnstile one half-wavelength above the first so as to cancel vertical radiation and reinforce horizontal radiation. The resulting turnstile array provides almost uniform horizontal radiation in all directions.

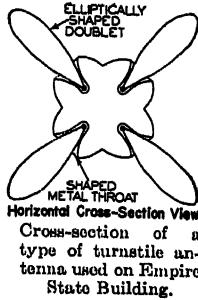

having their electrical axes oppositely poled.

twin-triode Two triode vacuum tubes in a single envelope.

twin wire A cable composed of two insulated conductors having a common covering.



Twisted pair of rubber-covered wires.

twisted pair A cable composed of two insulated conductors twisted together without a common covering.

twister A piezoelectric crystal that generates a voltage when twisted.

two-phase current Current delivered through two pairs of wires or a three-wire system to a single load, with a phase difference of one-quarter cycle or 90 degrees between the currents in the two pairs.

two-wattmeter method A method of measuring total power in a balanced or unbalanced three-phase system by adding the readings of two wattmeters. Each has its current coil in one phase and its voltage coil connected between that phase and the third phase.

two-way communication Communication between radio stations each having both transmitting and receiving equipment.

two-way repeater A vacuum-tube repeater used in a telephone line to amplify signals coming from either direction.

two-way switch A switch used for controlling lights or other electrical equipment from either of two positions.

two-wire line An electrical circuit formed by two conductors insulated from each other.

two-wire repeater A telephone repeater that provides for transmission in both directions over a two-wire telephone circuit. It may be either a 21 type or 22 type repeater. In the 21 type repeater, one amplifier serves to amplify the telephone currents in both

turntable The electric or spring motor-driven disk on which the record is placed in an electric phonograph, record player, or sound recorder.

turret A revolving plate sometimes mounted at the front of a television camera and carrying two or more lenses of different types, used to permit rapid interchange of lenses.

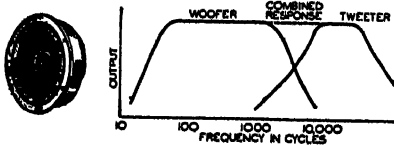

Tweeter loudspeaker—example and response curve.

tweeter A loudspeaker designed to handle only the higher audio frequencies (usually the range from about 6,000 to 15,000 cycles).

twinning One of two types of non-physical defects occurring in quartz crystals, resulting from structural misgrowth of otherwise perfect crystals yet giving no evidence of their presence in ordinary light. Optical twinning is the presence of both right-quartz and left-quartz in the same crystal. Electrical twinning is the presence of adjacent regions of quartz

TYNDALL EFFECT

directions, the circuit being arranged so that the input and output terminals of the amplifier are in one pair of conjugate branches, while the lines in the two directions are in another pair of conjugate branches. In the 22 type repeater, there are two amplifiers, one for each direction of the telephone currents.

Tyndall effect The scattering of light by very small suspended particles. The smaller the particles, the greater is the polarization of the scattered light. Polarization is complete for particle diameters less than 0.1 micron (0.001 millimeter). Suspension-type light valves utilize this effect.

type A facsimile A system of facsimile communication in which images are built up of lines or dots of constant intensity.

type A waves Continuous waves.

type A1 waves Unmodulated keyed continuous waves.

type A2 waves Modulated keyed continuous waves.

type A3 waves Continuous waves modulated by music, speech, or other sounds.

type A4 waves Super-audio-frequency modulated continuous waves, as used in facsimile systems.

type A5 waves Super-audio-frequency modulated continuous waves as used in television.

type B facsimile A system of facsimile communication in which images are built up of lines or dots of varying intensity, as in telephotography and photoradio.

type B waves Keyed damped waves.

type-printing telegraphy Telegraphy in which the message is automatically printed at the receiving station.

U Chemical symbol for uranium.

uhf Abbreviation for ultrahigh-frequency, a Federal Communications Commission designation for the band from 300 to 3,000 megacycles in the radio spectrum. Same abbreviation used for noun as for adjective.



Transmitting tube used in uhf applications.

ultradyn e reception A form of superheterodyne reception in which the intermediate-frequency signal is obtained from auxiliary oscillations superposed on the plate circuit of the first vacuum tube.

ultrahigh frequency A frequency in the band extending from 300 to 3,000 megacycles in the radio spectrum. Federal Communications Commission designations for the entire radio spectrum are:

vlf	10 to 30 kilocycles
l-f	30 to 300 kilocycles
m-f	300 to 3,000 kilocycles
h-f	3 to 30 megacycles
vhf	30 to 300 megacycles
uhf	300 to 3,000 megacycles
shf	3,000 to 30,000 megacycles

ultrahigh-frequency generator A device for generating extremely high-frequency alternating currents. The four main types are: (1) conventional negative-grid generators, (2) positive-grid or Barkhausen generators, (3) magnetrons, (4) velocity-modulation or electron-beam generators such as the klystron.

ultrahigh-frequency loop A loop antenna, generally having a single turn, used to secure a nondirectional radiation pattern in the plane of the loop in ultrahigh-frequency work. The pattern is doughnut-shaped in the perpendicular plane of the loop.

ultramicrometer An instrument for measuring very small displacements by electrical means, such as by the variation in capacitance resulting from the movement being measured.

ultrashort waves A general term applying to radio waves shorter than 10 meters in wavelength (above 30 megacycles in frequency). Waves shorter than 1 meter are usually called microwaves.

ultrasonic Having a frequency above that of audible sound. Also called *supersonic*.

ultraudion A name applied to any of several special vacuum-tube circuits employing regeneration.

ultraudion circuit A regenerative detector circuit in which a parallel resonant circuit is connected between the grid and the plate of a vacuum tube and a variable capacitor is connected between the plate and cathode to control the amount of regeneration.

ultraudion oscillator
A variation of the Colpitts oscillator circuit.

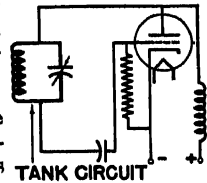

TANK CIRCUIT
Ultraudion oscillator.

ultraviolet A range of invisible radiation frequencies outside the visible spectrum at the violet end, and extending into the region of low-frequency X rays. Ultraviolet wavelengths range from about 136 to 4,000 angstrom units, with the range from 2,900 to 3,200 having the greatest physiological effect and the wavelengths shorter than 3,200 having the greatest photographic effect.

ultraviolet lamp A lamp providing a high proportion of ultraviolet radiation, such as various forms of arc lamps, mercury-vapor lamps, or incandescent

ULTRAVIOLET RAYS

lamps in bulbs of special glass transparent to ultraviolet rays.

ultraviolet rays Rays of ultraviolet radiation. They have powerful actinic effects, can cause ionization, and can produce phosphorescent and photoelectric effects. Used extensively in medicine for curative purposes as artificial sunlight, and to stimulate plant growth. Not appreciably transmitted by ordinary glass.

ultra-X rays Highly penetrating rays having even shorter wavelengths than gamma rays.

umbrella antenna An antenna in which the wires are guyed downward in all directions from a central pole or tower to the ground, somewhat like the ribs of an open umbrella.

uncertainty principle A feature of the quantum mechanics of Heisenberg, which postulates that it is impossible to specify complete information about electron processes in terms of the usual geometrical coordinates and of time. Thus, the position and velocity of an electron cannot be simultaneously expressed.

uncharged Having a normal number of electrons, and hence having no electrical charge.

undamped oscillations Oscillations that have constant amplitude for their duration.

undamped wave A continuous wave, produced by oscillations having constant amplitude.

underbunching The condition existing when the buncher voltage of a velocity-modulation tube is less than the value required for optimum bunching of electrons.

undercompounded A generator designed so that the output voltage drops as the load is increased.

undercutting Cutting too shallow a groove or cutting with insufficient lateral movement of the stylus during sound recording.

underdamping That condition of a system in which the amount of damping

is sufficiently small that one or more oscillations are executed when the system is subjected to a single disturbance.

underlap In facsimile, the amount by which the effective height of the scanning spot falls short of the nominal width of the scanning line. Excessive underlap leaves horizontal streaks in the reproduced copy.

underload relay A relay that operates when the load in a circuit drops below a certain value.

undermodulation Incomplete modulation at a transmitter due to electrical limitations of the modulator.

underthrow distortion In facsimile, the distortion resulting when the maximum amplitude of the signal wave front is less than the steady-state amplitude that would be obtained by a prolonged signal wave.

undistorted wave A periodic wave in which both the attenuation and velocity of propagation are the same for all sinusoidal components. No sinusoidal component is present at one point that is not present at all points.

undulatory Pertaining to wave motion.

unidirectional Flowing in only one direction, such as direct current.

unidirectional antenna An antenna designed to radiate with maximum strength in a particular direction and with minimum radiation in the opposite direction.

unidirectional current A current that flows in the same direction at all times. If it has essentially constant magnitude, it is called a direct current.

undyne reception Radio reception employing a circuit in which the same battery serves for filament and plate voltages, with an additional electrode being used to prevent excessive space charge in the tube.

unified field theory A mathematical theory developed by Einstein, involving Maxwell's electromagnetic theory and Einstein's mathematical theory of

UNLOADED ANTENNA

gravitation as special cases applying to all types of fields.

unifilar Having or using only one fiber, wire, or thread.

unifilar suspension Suspension of the moving system of a galvanometer or other instrument by a single fiber, wire, or thread whose torsion provides part or all of the restoring force.

uniform line A transmission line that has identical electrical properties throughout its length.

uniform plane wave A plane wave in which the displacement is uniform over the wave front.

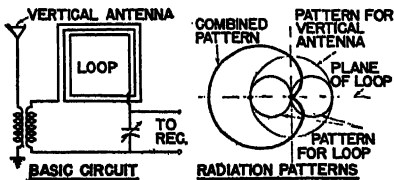

Unilateral direction finder and its radiation pattern.

unilateral bearing A bearing obtained with a radio direction finder having unilateral response, eliminating the chance of a 180-degree error.

unilateral conductivity Conductivity in only one direction, as in a perfect rectifier.

unipotential cathode A cathode to which heat is supplied by an independent heater element in a thermionic tube. Also called *equipotential cathode* or *indirectly heated cathode*.

unit 1. A distinct part, section, or component that can be regarded as an individual member of a related group. 2. The smallest whole number, hence one. 3. A determinate amount or quantity adopted as a standard of measurement for other amounts or quantities of the same kind.

unit charge That electrical charge which will exert a repelling force of one dyne on an equal and like charge one centimeter away in a vacuum, assuming that each charge is concentrated at a point.

unit magnetic pole A magnetic pole that will repel an equal magnetic pole of the same sign with a force of one dyne if the two poles are placed one centimeter apart in a vacuum.

unity coupling Perfect magnetic coupling between two coils, so that all the magnetic flux produced by the primary winding passes through the entire secondary winding.

unity power factor A power factor of 1.0, obtained when current and voltage are in phase, as in a circuit containing only resistance or in a reactive circuit at resonance.

universal motor A series-wound motor that may be operated at approximately the same speed and output on either direct current or single-phase alternating current.

universal output transformer An output transformer having a number of taps on its winding to permit its use between the audio-frequency output stage and the loudspeaker of practically any radio receiver by proper choice of connections.

universal receiver A radio receiver capable of operating either from alternating-current or direct-current power lines without changes in internal connections. It has no power transformer.

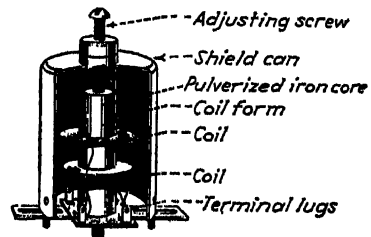

Universal replacement radio-frequency coil.

universal shunt A type of shunt devised by Ayrton to increase the range of a galvanometer without changing the damping. Also called *Ayrton shunt*.

unloaded antenna An antenna having no added inductance or capacitance.

UNMODULATED

unmodulated A carrier signal having no modulation, such as that transmitted during moments of silence in radio programs.

unmodulated groove A silent groove on a recording, cut without sound.

unmodulated keyed continuous waves Continuous waves that are broken up for telegraph signaling purposes by definite changes in either amplitude or frequency. Also called *type A1 wave*.

untuned Not resonant at any of the frequencies being handled.

uranium A radioactive element (symbol U) having an atomic number of 92 and an atomic weight of 238.07.

uranium series A radioactive series beginning with uranium and including radium.

urea plastic material A thermosetting plastic material that has good dielectric qualities, good strength, and can be produced in a wide assortment of colors including delicate pastel shades. Urea moldings are used for radio receiver cabinets, instrument housings, etc. Urea adhesives are used as bonding materials in the plywood industry. Urea plastics are available in a number of different types.

uvioi lamp A mercury-vapor lamp having a special glass envelope that is almost as transparent to ultraviolet rays as quartz.

v Letter symbol for voltage.

V 1. Letter used on diagrams to designate a voltmeter or a vacuum tube.
2. Roman numeral 5.

v Abbreviation for volt.

va Abbreviation for volt-ampere.

vacuum An enclosed space from which practically all air has been removed. Since an absolute vacuum (a space entirely free of matter) is impossible to obtain, the term vacuum is usually applied to the highest degree of exhaustion ordinarily attainable. A space well below atmospheric pressure but not completely evacuated is sometimes called a partial vacuum.

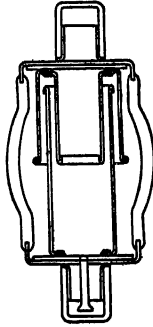

Cross-section view of typical vacuum capacitor having glass side walls.

vacuum gage A device that indicates the absolute gas pressure in a vacuum system, such as in the evacuated parts of a mercury-arc rectifier. The absolute gas pressure is expressed in microns, 1 micron being the pressure that will support a column of mercury 1/1,000 millimeter high. The two types of vacuum gages in common use

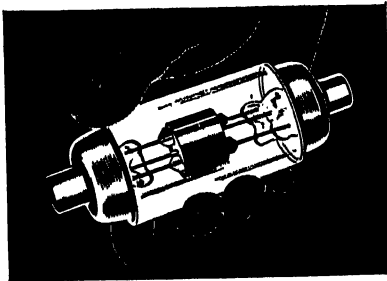

Vacuum capacitor used in radio transmitters.

are the McLeod gage and the hot-wire gage.

vacuum phototube A phototube evacuated to such a high degree that ionization cannot occur.

vacuum seal The airtight junction between component parts of the vacuum chamber of a mercury-arc rectifier, electron microscope, cathode-ray oscilloscope, or other apparatus.

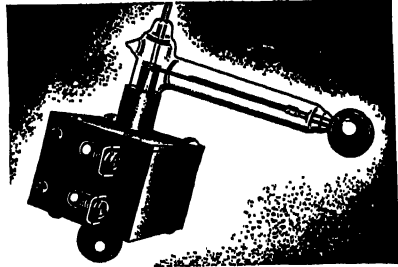

Vacuum relay capable of handling 20,000 volts at radio frequencies without flashover.

vacuum switch A switch having its contacts in an evacuated bulb to minimize sparking. The switch may be operated electromagnetically, operated by applying pressure to a flexible bellows-like portion of the glass envelope, operated by expansion due to a heating element through which current is sent inside the tube, or actuated externally by other means.

vacuum tank The airtight metal chamber that contains the electrodes of a mercury-arc rectifier or similar tube and in which the rectifying action takes place.

vacuum tube A device consisting of an evacuated enclosure containing a number of electrodes between any two or more of which conduction of electricity through the vacuum or contained gas may take place. Vacuum tube is therefore a general term covering all

VACUUM-TUBE AMPLIFIER

tubes—phototubes, cathode-ray tubes, mercury-vapor tubes, gas tubes, thermionic tubes, high-vacuum tubes, glow tubes, X-ray tubes, etc.

vacuum-tube amplifier An amplifier using vacuum tubes to control the power obtained from a local source.

vacuum-tube keying A code-transmitter keying system in which a vacuum tube is connected in series with the plate supply lead going to the center tap of the winding in the plate circuit of the final stage, with the grid of the tube connected to its filament through the transmitting key. When the key is open, the tube blocks, interrupting the plate supply to the output stage. Closing the key allows plate current to flow through the keying tube and the output tubes.

vacuum-tube modulator A modulator employing a vacuum tube as a modulating element for impressing an intelligence signal on a carrier.

vacuum-tube oscillator A circuit utilizing a vacuum tube to convert direct-current power into alternating-current power at a desired frequency.

vacuum-tube rectifier A rectifier in which rectification is accomplished by the unidirectional passage of electrons from a heated electrode to one or more other electrodes within an evacuated space.

vacuum-tube transmitter A radio transmitter in which vacuum tubes are utilized to convert the applied electric power into radio-frequency power.

vacuum-tube voltmeter A voltage-measuring instrument utilizing the characteristics of a vacuum tube for measuring voltages with minimum effect on the circuit to which the instrument is connected.

valence A measure of the extent to which an atom is able to combine directly with other atoms. It is believed to depend on the number and arrangement of the electrons in the outermost shell of the atom.

valence electron One of the outer electrons of an atom, believed to be respon-

sible for chemical combination, visible light, and thermal radiation. Also called *peripheral electron*.

valve 1. British term for a vacuum tube.
2. A device permitting current flow in one direction only, such as a rectifier.

valve tube An electric valve consisting of a vacuum tube having a hot filament and one electrode. This term is used in radiology and corresponds to a thermionic rectifier.

van de Graaff generator An electrostatic generator utilizing an endless moving belt of insulating material to collect electric charges by induction and discharge them inside a large hollow spherical terminal to produce a high direct voltage.

van der Bijl equation In a triode tube having an amplification factor μ , a plate voltage V_P and a grid voltage V_G , the plate current is $I_P = a(V_P + \mu V_G + c)$, in which a and c are constants.

vane-type instrument A measuring instrument utilizing the force of repulsion between fixed and movable magnetized iron vanes, or the force existing between a coil and a pivoted vane-shaped piece of soft iron, to move the indicating pointer.

V antenna A long linear radiator partially folded on itself in the form of a V, used singly or as an element of a directional array.

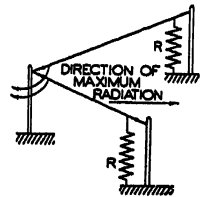

V antenna.

vapor pressure The pressure of the vapor of a liquid that is kept in confinement so that the vapor can accumulate above it, as in a mercury-vapor rectifier tube.

var The unit of reactive power. One var is one reactive volt-ampere. This name was adopted by the International Electrotechnical Commission in 1930.

var-hour meter An electricity meter for measuring and registering reactive volt-ampere-hours. Also called *reactive volt-ampere-hour meter*.

variable-area recording The RCA system of recording sound on motion-picture film, in which the width or area of the solid black sound track on the film varies constantly in accordance with audio-frequency signal variations.

variable capacitor

An air-dielectric capacitor whose capacitance can be varied by adjusting the amount of meshing between a fixed set of plates (the stator) and a rotating set of plates (the rotor), or sometimes by varying the spacing between fixed plates as in a trimmer capacitor.

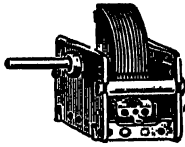

Variable capacitor.

variable coupling Inductive coupling that can be varied by moving windings with relation to others.

variable-density recording The Western Electric system of recording sound on motion-picture film, in which the sound track is of uniform width but changes in density in accordance with audio-frequency signal variations.

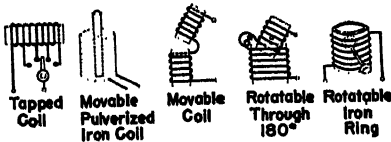

Variable inductances.

variable inductance A coil (inductor) whose inductance value can be varied.

variable- μ tube

A type of thermionic vacuum tube having a grid so designed that the amplification factor and the mutual conductance can be varied by adjusting the grid-bias-voltage value.

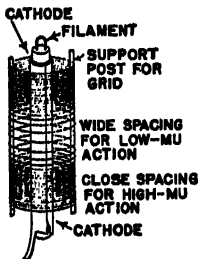

Spacing of grid wires in variable- μ tube.

variable resistance

A resistor whose value can be changed at will while in use.

variable-speed motor A motor whose speed can be adjusted within certain limitations, regardless of load.

variable-speed scanning A scanning method whereby the speed of deflection of the scanning beam in the cathode-ray tube of a television camera is governed by the optical density of the film being scanned. The beam in the receiving cathode-ray tube has constant intensity but moves in synchronism with the transmitting beam through interconnection of deflecting circuits. This reproduces the original picture since the apparent illumination of the screen depends on the speed of the beam.

variable transformer An iron-core transformer having provisions for varying its output voltage over a limited range or continuously from zero to maximum output voltage, generally by means of a contact arm moving along exposed turns of the secondary winding.

Variac Trade name for one type of variable transformer.

variocoupler A radio-frequency transformer having provisions for varying the coupling between the two windings. Its construction is like that of a variometer, but its coils are not connected together.

variometer A variable inductance having two coils in series, one mounted inside the other, with provisions for rotating the inner coil in order to vary the total inductance of the unit over a wide range.

Varley loop test A method of using a Wheatstone bridge to determine the distance from the test point to a fault in a telephone or telegraph line or cable.

var meter An instrument for measuring reactive volt-amperes. Also called *reactive volt-ampere meter*.

varnished cambric Linen or cotton fabric that has been impregnated with varnish or insulating oil and baked. Used for insulating purposes in the construction of coils and other radio parts.

VECTOR ADMITTANCE

vector admittance The ratio, for a simple sinusoidal current and potential difference in a portion of a circuit, of the corresponding complex harmonic current to the corresponding complex potential difference.

vector diagram An arrangement of vectors showing the relations between alternating quantities having the same frequency.

vector impedance The ratio, for a simple sinusoidal current and potential difference in a portion of a circuit, of the corresponding complex harmonic potential difference to the corresponding complex current.

vector power A vector quantity equal in magnitude to the square root of the sum of the squares of the active power and the reactive power. The unit is the vector volt-ampere.

vector power factor The ratio of the active power to the vector power. It is the same as power factor in the case of sinusoidal quantities.

vector quantity A quantity having both magnitude and direction, such as magnetic intensity.

vee antenna A long linear radiator partially folded on itself in the form of a V, used singly or as an element of a directional array.

velocity A vector quantity denoting both the direction and the speed of a linear motion, or denoting the direction of rotation and the angular speed in the case of rotation.

velocity microphone A microphone in which the electrical response corresponds to the particle velocity resulting

from the propagation of a sound wave through an acoustic medium. Examples are hot-wire and ribbon microphones. In the ribbon microphone, a single thin lightweight corrugated metal ribbon mounted between the poles of permanent magnets is moved back and forth in the magnetic field by sound waves, and the audio-frequency output voltage is thus induced in the ribbon.

velocity-modulated tube An inductive-output tube in which the electron stream is modulated in velocity and, in the course of subsequent passage through the output electrodes, may induce oscillatory energy into the output circuit.

velocity modulation Modification of the velocity of the electrons in a beam. The term usually implies that the variations of electron velocity are utilized to convert direct-current beam energy into radio-frequency energy.

velocity-modulation generator An ultrahigh-frequency vacuum tube in which an originally continuous stream of electrons of uniform velocity is transformed at a certain point, by application of a radio-frequency voltage, into successive bunches or waves of electrons. The tube contains an electron gun that projects a narrow beam of electrons which have been accelerated by a voltage of several hundred or even thousands of volts. These electrons pass through a narrow gap between two grids, where they are subjected to an alternating voltage supplied by an oscillating circuit. Some of the electrons emerging from the gap have slightly greater and others slightly smaller than average velocities, with the result that faster electrons catch up with slower electrons and cause bunching of electrons. As a result, ultrahigh frequencies are generated.

velocity of propagation The velocity at which a disturbance is radiated as a wave through a medium. For light, this velocity is approximately 186,000 miles per second, or approximately 3×10^{10} centimeters per second, with

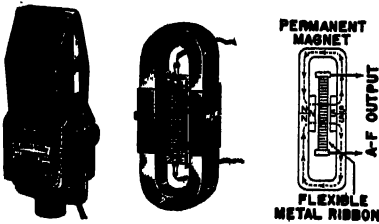

Velocity microphone—example and construction.

the velocity of radio waves being essentially the same.

velocity resonance Resonance in which the angular phase difference between the fundamental components of the oscillation and the applied agency is 90 degrees. More often called *phase resonance* or simply *resonance*.

velocity spectrograph An apparatus for separating an emission of electrically charged particles into distinct streams in accordance with their speed by means of magnetic or electric deflection.

Verdet's constant The coefficient that determines the angle of rotation of the plane of polarization in a beam of plane-polarized light passing through certain materials in a magnetic field.

vernier Any device, control, or scale used to obtain fine adjustment for more accurate measurement, such as a vernier control, vernier capacitor, or vernier scale.

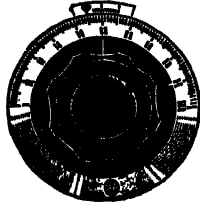

Vernier reading dial.

vernier capacitor A small variable capacitor placed in parallel with a larger tuning capacitor to provide a finer adjustment after a larger unit has been set approximately to the desired position.

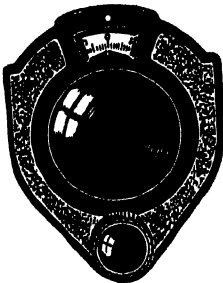

Vernier tuning dial.

vernier dial A type of tuning dial in which each complete rotation of the control knob causes only a fraction of a revolution of the main shaft, permitting fine and accurate adjustment. Used chiefly for tuning radio equipment.

VERTICALLY POLARIZED WAVE

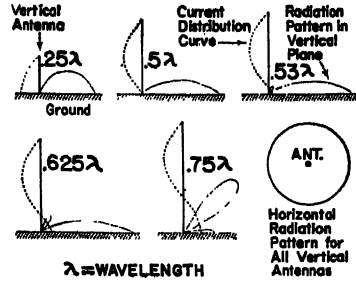

Vertical radiation patterns for vertical antennas of various heights. All have the same circular horizontal radiation pattern.

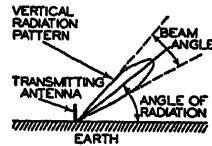

Vertical radiation pattern of a beam-antenna system.

vertical antenna A vertical steel tower, metal rod, or suspended wire used as an antenna.

vertical centering control A control provided in a television receiver or cathode-ray oscilloscope to shift the position of the entire image vertically in either direction on the screen.

vertical deflecting electrodes The pair of electrodes that serves to move the electron beam up and down on the fluorescent screen of a cathode-ray tube employing electrostatic deflection.

vertical hold control The hold control that changes the frequency of the vertical sweep oscillator in a television receiver.

vertical-incidence transmission The transmission of a radio wave vertically to the ionosphere and back. The transmission is practically the same for slight departures from the vertical, such as when the transmitter and receiver are a few miles apart.

vertically polarized wave A linearly polarized wave whose direction of polarization is vertical.

VERTICAL POLARIZATION

vertical polarization The condition in which radio waves are transmitted with their plane of polarization initially perpendicular to the surface of the earth.

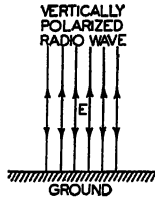

vertical radiator A Vertical polarization antenna. The two types are the insulated series-excited vertical radiator and the grounded shunt-excited vertical radiator.

vertical recording A type of phonograph recording in which the cutting stylus of the sound recorder moves up and down rather than from side to side during recording. Also called *hill-and-dale recording*.

vertical sweep The downward movement of the scanning beam from top to bottom of the picture being televised.

very high frequency A frequency in the band extending from 30 to 300 megacycles in the radio spectrum. Federal Communications Commission designations for the entire radio spectrum are:

vlf	10 to 30 kilocycles
l-f	30 to 300 kilocycles
m-f	300 to 3,000 kilocycles
h-f	3 to 30 megacycles
vhf	30 to 300 megacycles
uhf	300 to 3,000 megacycles
shf	3,000 to 30,000 megacycles

very low frequency A frequency in the band extending from 10 to 30 kilocycles in the radio spectrum. Supersonic frequencies are in this frequency range but are not in the radio spectrum because they are not electromagnetic waves.

vestigial Pertaining to a remnant or remaining part.

vestigial sideband The transmitted portion of an amplitude-modulated wave after a sideband has been largely suppressed by a transducer (filter) having a gradual cutoff in the neighborhood of the carrier frequency. The other sideband is transmitted without substantial suppression.

vestigial-sideband transmission That method of signal transmission, for amplitude modulation, in which one normal complete sideband and the corresponding vestigial sideband are utilized.

vestigial-sideband transmitter An amplitude-modulated radio transmitter in which one complete sideband and a portion of the other sideband are intentionally transmitted.

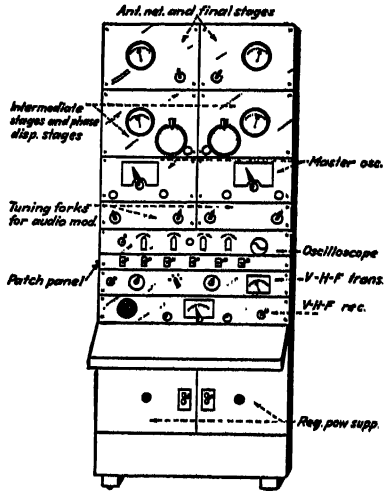

Range and communication bay for vhf ground station providing navigational facilities for aircraft.

vhf Abbreviation for very high frequency, a Federal Communications Commission designation for the band from 30 to 300 megacycles in the radio spectrum. Same abbreviation used for noun as for adjective.

vibrating-reed instrument A frequency meter consisting of a row of steel reeds, each having a different natural frequency. All are excited by an electromagnet that is fed with the alternating current whose frequency is to be measured. The reed whose frequency corresponds most nearly with that of the current vibrates. The frequency value is read on a scale beside the row of reeds.

vibrating-reed rectifier An electromagnetic device for rectifying an alternating current by reversing the connections

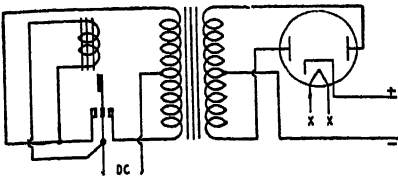

Diagram of representative vibrating-reed rectifier in a power-pack circuit.

between the power line and load each time the alternating current reverses in direction. The reversing contacts are on a vibrating reed of magnetic material that is acted on by a coil carrying the alternating current, so that the reed moves in synchronism with the current.

vibration A periodic motion of an elastic body or medium in alternately opposite directions from the position of equilibrium, so that some value is continually changing in such a manner that it passes through maxima and minima.

vibration galvanometer A type of alternating-current galvanometer in which the natural oscillation frequency of the moving element is equal to the frequency of the current being measured.

vibration meter An instrument used to measure the displacement, velocity, and acceleration associated with mechanical vibration. In one form it consists of a piezoelectric vibration pickup having uniform response from 2 to 1,000 cycles, feeding an amplifier having an indicating meter at its output.

vibration pickup A form of microphone designed to respond to mechanical vibrations rather than to sound waves. One type employs a piezoelectric unit, in which twisting or bending of a Rochelle salt crystal generates a voltage that varies in accordance with the vibration being analyzed.

vibrator An electromagnetic device for converting a direct voltage into an alternating voltage. It contains a vibrating armature that reverses the direction of current flow during each vibration. Used extensively in the power packs of auto radios and other

portable equipment to convert the voltage of a storage battery into a low alternating voltage that can be stepped up by a power transformer and then rectified either in a conventional rectifier tube circuit or by an additional set of contacts on the vibrator itself.

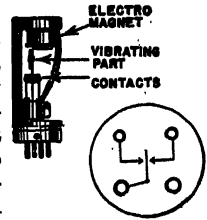

Vibrator construction and symbol.

vibrograph An apparatus for recording mechanical vibrations.

vibroscope An apparatus consisting of tuning forks vibrating at right angles, used by Lissajous for studying harmonic motions.

video Pertaining to the picture signals or sections in a television system.

video frequencies Frequencies existing in the output of a television camera as a result of scanning the image being transmitted. They may have any value from almost zero to well over 4 million cycles. Also called *visual frequencies*.

video-frequency amplifier An arrangement of one or more vacuum-tube stages designed to handle the entire range of video frequencies and amplify them after demodulation in a television receiver. Used also in television stations to amplify the output of the television camera.

video signal The picture signal in a television system. This term is generally applied to the signal as it exists at the output of a television camera, before the addition of the synchronizing pulses.

viewing screen The medium that converts the useful energy of the electrons in the beam of a cathode-ray tube into visible radiation. The screen generally consists of a coating of fluorescent material on the inside surface of the large end of the cathode-ray tube.

Villari effect The phenomenon in which a change in magnetic induction occurs

VINYL RESIN

when a mechanical stress is applied along a specified direction to a magnetic material having magnetostriction properties.

vinyl resin A soft plastic material sometimes used for pressings when absence of needle scratch is preferable to long life, as in transcriptions for broadcast purposes.

virtual cathode The electron cloud that forms around an outer grid in a thermionic vacuum tube when an inner grid is maintained at a slightly positive potential with respect to the cathode.

virtual height The height, for an ionized layer of the ionosphere, at which reflection from a definite boundary surface would cause the same time of travel as the actual reflection of a wave from the ground to the ionosphere and back again. The virtual height depends on the wave components and the frequency; it is usually stated for the ordinary wave and for the lowest frequency at which reflection occurs. Sometimes called *effective height* or *equivalent height*.

virtual image An optical counterpart of an object, formed at imaginary foci by prolongations of light rays. The image that appears to be behind an ordinary mirror is a virtual image.

visible radiation Radiation having wavelengths ranging from about 4,000 to 8,000 angstrom units, corresponding to the visible spectrum of light.

visual broadcast service A service rendered by stations broadcasting images

for general public reception, such as by television broadcast stations and facsimile broadcast stations.

visual frequencies Frequencies existing in the output of a television camera as a result of scanning the image being transmitted. They may have any value from almost zero to well over 4 million cycles. Also called *video frequencies*.

visual transmitter The radio equipment used for the transmission of the visual (picture) signal only from a television broadcast station. The complete equipment for both visual and aural signals is known as a television transmitter.

vita-rays A term sometimes applied to the range of ultraviolet rays from 2,000 to 3,200 angstrom units, which have a maximum physiological effect.

vitreous Having the nature of glass.

vlf Abbreviation for very low frequency, a Federal Communications Commission designation for the band from 10 to 30 kilocycles in the radio spectrum. Same abbreviation used for noun as for adjective.

vodas A switching apparatus employed in radio telephony, consisting of a vacuum-tube arrangement serving as a relay that connects a subscriber's line automatically to the transmitting station as soon as he starts speaking and simultaneously disconnects it from the receiving station. It performs the reverse operation when he is listening and has the effect of permitting the use

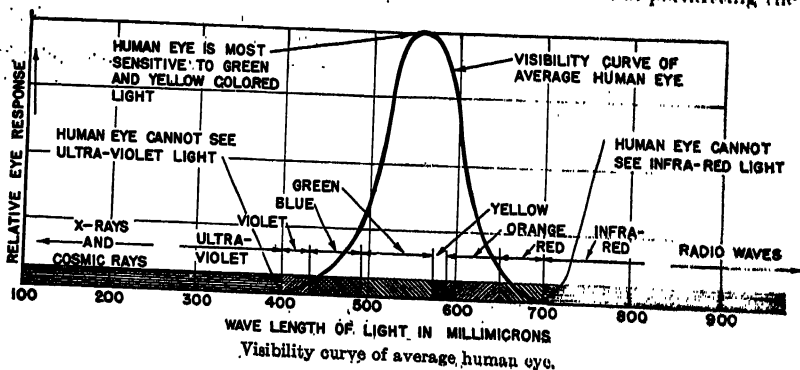

VOLTAGE DROP

of one radio channel for both transmitting and receiving without appreciable switching delay as the parties alternately talk.

voder An electronic device using vacuum tubes in connection with electrical filters controlled through a keyboard, capable of artificial production of voice sounds. The name is a contraction of voice operation demonstrator.

vogad A method of maintaining constant speech output level in long-distance radio telephony, utilizing a principle similar to that of automatic volume control. The name is an abbreviation of voice-operated gain adjusting device.

voice coil The moving coil that is attached to the diaphragm of a dynamic loudspeaker and moves through the air gap between the pole pieces.

voice frequency The frequency range of ordinary speech, extending from about 100 to 2,000 cycles.

voice-frequency carrier telegraphy That form of carrier telegraphy in which the carrier currents have frequencies such that the modulated currents may be transmitted over a voice-frequency telephone channel.

voice-frequency telegraph system A telegraph system permitting use of up to 18 channels on a single circuit. A different audio frequency generated by a tuning-fork-controlled vacuum-tube oscillator is used for each channel, being keyed in the conventional manner. The various audio frequencies at the receiving end are separated by suitable filter circuits and fed to their respective receiving circuits.

voice-frequency telephony That form of telephony in which the transmitted electric wave has substantially the same frequency at each instant as the corresponding actuating sound wave. This condition does not exist in carrier telephony over wires.

volt The practical unit of voltage, potential or electromotive force. One volt will send a current of one ampere

through a resistance of one ohm. Named after the Italian physicist Alessandro Volta, 1745-1829.

Volta effect The difference of potential that exists when dissimilar metals are placed in contact. Also called *contact potential*.

voltage The term most often used in place of electromotive force, potential, potential difference, or voltage drop, to designate the electric pressure that exists between two points and is capable of producing a flow of current when a closed circuit is connected between the two points.

voltage amplification The ratio of the alternating voltage produced at the output terminals of an amplifier to the alternating voltage applied to the input terminals.

voltage amplifier A vacuum-tube amplifier designed primarily to build up the voltage of a signal without being called upon to supply appreciable power.

voltage divider A resistor provided with two fixed terminals to which a voltage is applied, and with additional fixed or movable contacts. Current is passed between the fixed end terminals, and a desired fractional part of the total applied voltage is obtained across a portion of the resistor.

voltage doubler A transformerless rectifier circuit that gives double the output voltage of a conventional vacuum-tube rectifier by charging a capacitor during one half-cycle and discharging it in series with the output voltage during the next half-cycle.

voltage drop The voltage developed between the terminals of a circuit component by the flow of current

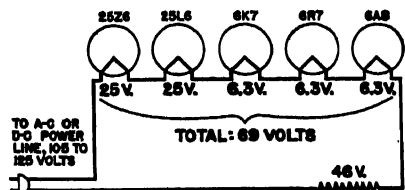

Voltage-dropping resistor in use.

VOLTAGE FEED

through the resistance or impedance of that part.

voltage feed Excitation of a transmitting antenna by applying voltage at a point of maximum potential (at a voltage loop or antinode).

voltage gradient Voltage per unit length along a resistor or other conductive path.

voltage multiplier 1. A series arrangement of capacitors charged by rapidly rotating brushes in sequence, giving a high direct voltage equal to the source voltage multiplied by the number of capacitors in series. 2. A precision resistor used in series with a voltmeter to extend its measuring range.

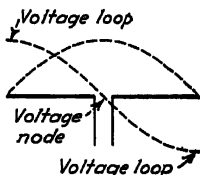

Voltage node and loops on a half-wave antenna.

voltage node A point having zero voltage in a stationary wave system. A voltage node exists at the center of a half-wave antenna.

voltage rating The maximum sustained voltage that can safely be applied to an electrical device without risking the possibility of electrical breakdown. The various types of voltage ratings are usually self-explanatory.

voltage-regulating transformer A power transformer designed to deliver an essentially constant output voltage over a wide range of input voltage values.

voltage regulation The ability of a voltage source to maintain essentially constant output voltage during variations in load.

voltage regulator A device that functions to maintain the terminal voltage of a generator or other machine at a predetermined value, or varies the voltage according to a predetermined plan.

voltage-regulator tube A two-electrode gas-filled vacuum tube sometimes used in radio receivers to keep the alternating input voltage to the receiver essentially constant despite wide variations in line voltage, or to maintain an essentially constant direct voltage in a circuit.

voltage relay A relay that functions at a predetermined value of voltage.

voltage saturation The condition in which the plate current of a thermionic vacuum tube cannot be further increased by increasing the plate voltage. The electrons are then being drawn to the plate at the same rate as they are emitted from the cathode. Also called *current saturation* or *plate saturation*.

voltage to ground The voltage between any live conductor and the earth.

voltage transformer An instrument transformer intended for measurement or control purposes, and designed to have its primary winding connected in parallel with the circuit whose voltage is to be measured or controlled. Also called *potential transformer*.

voltage-type telemeter A telemeter that employs voltage as the translating means.

voltic cell An early name for a primary cell.

voltic couple Two dissimilar metals in contact, resulting in a contact potential difference.

voltic pile A voltage source consisting of a pile of alternate pairs of dissimilar metal disks, with moistened pads between pairs, forming a number of elementary primary cells in series. Made by Volta in 1796.

voltmeter An electricity meter having the form of an electrolytic cell, arranged to measure the quantity of electricity in coulombs passing through a conductor. Actually, it measures the amount of electrolysis produced by the current in the electrolytic cell. Also called *coulometer*.

voltammeter 1. A wattmeter. 2. An instrument that may be used either as a voltmeter or ammeter.

volt-ampere The unit of apparent power in an alternating-current circuit containing reactance. Apparent power is equal to the voltage in volts multiplied by the current in amperes, without taking phase into consideration.

Volta's law The contact potential difference developed between two dissimilar conductors when first placed in contact is the same whether the contact is direct or through one or more intermediate conductors.

voltmeter An instrument for measuring voltage. Its scale is usually graduated in microvolts, millivolts, volts, or kilovolts.

volt-ohm-milliammeter A single test instrument having a number of different ranges for measuring voltage, current, and resistance. Also called *multimeter*, *multiple-purpose tester*, etc.

volt-second The practical unit of magnetic flux, equal to 10^8 maxwells. Usually called *weber*.

volume 1. In a telephone or other audio-frequency circuit, a measure of the power corresponding to an audio-frequency wave at that point, usually expressed in decibels with respect to an arbitrary standard. 2. In general, the intensity or loudness of the sound produced by a headphone or loudspeaker.

volume compression Limitation of the volume range of a radio program to a variation of about 30 to 40 decibels at the transmitter, to permit using a higher average percentage modulation without risk of overmodulation.

volume control A potentiometer or rheostat used to vary the audio-frequency output of a radio receiver or public-address amplifier.

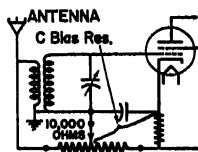

Antenna C-bias volume-control circuit.

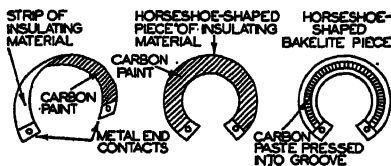

Three types of carbon-type volume-control construction.

volume expander A special audio-frequency circuit arrangement sometimes used to increase the volume range of a radio program or phonograph record by making weak sounds weaker and loud sounds louder, thereby counteracting volume compression at the transmitter.

volume expansion A method of increasing the volume range of reproduced sounds to obtain greater naturalness and reduce background noise.

volume indicator A type of high-impedance voltmeter, usually of the vacuum-tube type, designed to measure volume in a telephone circuit or other audio-frequency circuit.

volume unit A unit used to specify the audio-frequency power level in decibels above a reference level of 1 milliwatt (0.001 watt). A volume unit is equal to a decibel only when changes in power are involved or when the decibel value has this same reference level. It is unnecessary to specify the reference level when dealing in volume units because the level is a part of the definition.

volume-unit indicator An instrument calibrated to read audio-frequency power levels directly in volume units.

Vreeland oscillator A device for producing a sinusoidal current by means of a mercury arc in a periodically varying field.

VT Symbol used on diagrams to designate a vacuum tube.

vtrm Abbreviation for vacuum-tube voltmeter.

vu Abbreviation for volume unit.

W Letter used in equations to designate power in watts.

w Abbreviation for watt.

wafer socket A vacuum-tube socket consisting of two punched sheets or wafers of an insulating material, between which are spring metal clips that grip the terminal pins of a tube inserted in the socket.

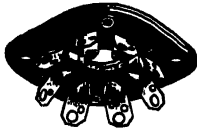

Wafer socket.

Wagner ground A device that offsets capacitance effects between an alternating-current bridge and the ground, preventing false indications.

walkie-talkie A compact portable combination radio transmitter and receiver that can be carried by one man, usually strapped over the back, and used for communication over medium distances.

wall outlet A spring-contact device installed at an outlet and connected permanently to the power-line wiring of a building. It permits connection of a portable lamp or appliance to the power line by means of a plug and flexible cord. Also called *convenience receptacle* or *receptacle*.

walls The sides of a phonograph groove.

War Emergency Radio Service A temporary communication service intended solely for emergency communication in connection with the national defense and security. Abbreviated WERS.

watch The service performed by a qualified operator when on duty in the radio room of a vessel listening for signals of other stations on the international

calling and distress frequency, 500 kilocycles, and at all other times when such operator is engaged in transmitting or receiving signals or messages on any authorized frequency, to or from any station in the maritime mobile service, or in receiving from any station time signals, weather reports, hydrographic reports, reports regarding aids to navigation, authorized press material, or information regarding the safety of life or property at sea. Also called *radio watch*.

water-cooled tube A vacuum tube having an anode structure projecting through the glass envelope and constructed so as to permit circulation of water around the anode for cooling purposes during operation.

watt The practical unit of electric power. In a direct-current circuit, the power in watts is equal to volts multiplied by amperes. In an alternating-current circuit, the true power in watts is effective volts multiplied by effective amperes, then multiplied by the circuit power factor. There are 746 watts in 1 horsepower. The term is named after James Watt, Scottish inventor.

wattage rating A rating expressing the maximum power that a device can safely handle. It is usually a conservative rating, and higher power can be safely handled often for short periods of time under certain conditions.

watt-hour The practical unit of electrical energy, equal to a power of one watt being absorbed continuously for a time of one hour. One kilowatt-hour is equal to 1,000 watt-hours.

watt-hour meter An electricity meter that measures and registers electric energy in watt-hours or kilowatt-hours.

wattless component The reactive component.

wattless power That component of the apparent power in an alternating-current circuit which is delivered to the circuit during part of a cycle but is returned to the source during another part of the cycle. Also called *reactive volt-amperes*. The practical unit of wattless power or reactive power is the var, equal to one reactive volt-ampere.

wattmeter A meter for measuring electric power, usually by means of two interacting circuits, one in series with the line and one across the line so as to give a deflection that is proportional to the product of line voltage and the inphase component of line current. Its scale is usually graduated in watts or kilowatts.

watt-second The amount of energy corresponding to one watt acting for one second. One watt-second is equal to one joule.

wave 1. A propagated disturbance, usually periodic, such as a radio wave or sound wave. 2. A single cycle of a periodic propagated disturbance. 3. A periodic variation represented by a graph.

wave angle The angle at which a radio wave arrives at a receiving antenna or leaves a transmitting antenna. Two values are needed to specify the exact angle in space: the azimuth angle which represents direction along the surface of the earth, and the elevation angle which gives the vertical angle with respect to the surface of the earth.

wave antenna A system of horizontal conductors having a length of the order of several wavelengths of the wavelength used and operating by virtue of the tilt of radio waves passing along the ground. It is so used as to be directional, is generally supported only a few feet above the ground, and has resistances that prevent reflections from its ends. Also called *Beverage antenna*.

wave band A band of frequencies, such as that assigned to a particular type of radio communication service.

wave-band switch A multiposition switch used to change the tuning range of a receiver or transmitter from one wave band to another.

wave converter A device for changing a wave of given pattern into a wave of another pattern. Baffle-plate converters, grating converters, and sheath-reshaping converters for wave guides are typical examples.

wave duct A wave guide with tubular boundaries, capable of concentrating the propagation of waves within its boundaries.

wave equation An equation that gives a mathematical specification of a wave process, or describes the performance of a medium through which a wave is passing.

waveform The pictorial representation of the shape of a wave, showing variations in amplitude with respect to time.

wavefront 1. A continuous surface at the beginning of a wave in space, at every point of which the displacement from zero in a given direction has the same value at any given instant. 2. In a signal-wave envelope, that part (in time or distance) between the initial point of the envelope and the point at which the envelope reaches its crest. The remainder of the envelope is called the *wave tail*.

wave function A point function that, in a wave equation, specifies the amplitude of a wave.

wave group The resultant of two or more wave trains of different frequency traversing the same path.

wave guide A hollow metal tube or solid dielectric cylinder capable of propagating electromagnetic waves through their interiors or radiating them into space, at frequencies of

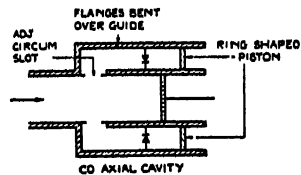

Use of coaxial cavity for reception of waves at the end of a cylindrical wave guide. Crystal detectors convert the wave energy into useful form.

WAVE INTERFERENCE

about 1,000 megacycles and higher. Widths or diameters range from $\frac{1}{2}$ to 12 inches or more. There are two classes of guides: (1) dielectric guides consisting of solid dielectric cylinders surrounded by air, and having little practical use due to the high losses occurring in solid dielectrics; (2) conducting guides, which are air-filled, gas-filled, or evacuated hollow metal tubes of circular, rectangular, or other cross-section. The metal wall is called the sheath of the guide; it may be any conducting material, and may be as thin as practicable. Electromagnetic waves travel through guides much as sound waves travel through a speaking tube.

wave interference The process that makes it possible to reinforce radiation in a desired direction from an antenna array by suppressing radiation in undesired directions. A large number of sources of radiation are so positioned and excited that their resulting waves interfere with each other to produce the cancellation and reinforcement of waves required for the desired directional characteristics.

wavelength The distance between successive peaks of the same polarity in a wave. It corresponds to the distance traveled by the wave in a time of one cycle. For electromagnetic waves traveling through space, the wavelength in meters is equal to 300 divided by the frequency in megacycles, or to 300,000 divided by the frequency in kilocycles.

wavelength constant The imaginary part of the propagation constant. Also called *phase constant*. The real part is the attenuation constant.

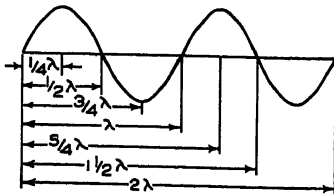

λ = SYMBOL FOR WAVE LENGTH

Wavelengths of antennas.

wavelength units Units used to express wavelength of electromagnetic radiation, such as radio waves, light, and X rays. Examples are:

Name	Abbreviation	Value in mm	Used in
Meter	m	1000	Radio
Centimeter	cm	10	Radio
Millimeter	mm	1	Radio
Micron	μ	10^{-3}	Light
Millimicron	m μ	10^{-4}	Light
Angstrom	A	10^{-7}	Light
X unit	Xu	10^{-10}	X rays

wave mechanics A general physical theory that assigns wave characteristics to the components of atomic structure and seeks to interpret all physical phenomena in terms of hypothetical wave forms. Introduced by Schroedinger in 1926.

wavemeter A calibrated electric resonator whose resonant frequency can be adjusted. Used to measure the wavelength or frequency of a radio wave or electric oscillation.

wave normal The direction normal or perpendicular to the wave front and toward the direction of propagation.

wave reception Any means of converting a wave proceeding through a guide into useful form for amplification by a telephone or television amplifier. Examples are crystal detectors in detecting wire gratings, in quarter-wave terminations, in tuned resonating cavities, in disk-shaped or coaxial cavities, and in heterodyne detector arrangements.

wave tail In a signal-wave envelope, that part (in time or distance) between the termination of the steady-state value (or crest when the steady-state value is not reached) and the end of the envelope in a facsimile system.

wave tilt The forward inclination of the waveform of radio waves arriving along the ground. Its value depends on the electrical constants of the ground.

wave train A limited series of wave cycles caused by a periodic disturbance of short duration.

wave trap A resonant circuit connected into the antenna system of a radio

WHEATSTONE BRIDGE

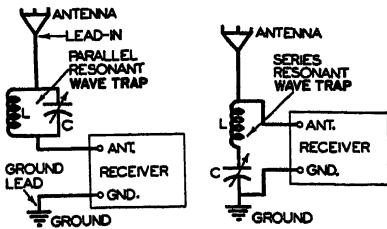

Series and parallel resonant types of wave traps.

receiver to suppress signals at a particular frequency such as that of a powerful local station that is interfering with reception of other stations.

wave velocity The product obtained by multiplying together the wavelength and the frequency of a wave. This assumes a nondispersive medium such as air. For a dispersive medium in which waves of different lengths are transmitted at different velocities, the corresponding quantity is called *phase velocity*.

wax The heavy blank wax disk used in making the master record required for the production of phonograph records.

weak coupling Loose coupling, in a radio-frequency transformer.

weber The practical unit of magnetic flux, equal to 10^8 maxwells. At various times, the weber has represented the centimeter-gram-second unit of magnetic flux (now the maxwell), the unit of current (now the ampere), and the unit of quantity of electricity (now the coulomb), but all these uses are now obsolete. Sometimes called *volt-second*.

Wehnelt cathode A hot cathode consisting of a metallic core coated with alkaline-earth oxides. Widely used in radio tubes.

Wehnelt interrupter A device in which the current passing between a fine wire and an electrolyte is interrupted at regular intervals by the formation and collapse of small bubbles of vapor.

weld A consolidation of metals by a welding process.

welded joint A union of two or more parts by welding.

welding transformer A power transformer having a secondary winding consisting of only a few turns of very heavy wire, used to produce high-value alternating currents at low voltages for welding purposes.

WERS Abbreviation for War Emergency Radio Service.

Wertheim effect A change in the magnetization of a ferromagnetic wire or rod when twisted.

Western Union joint A joint or splice having good mechanical strength as well as good conductivity, made by crossing the cleaned ends of two wires, then winding the end of each wire around the other wire and soldering the joint.

Weston cell A standard cell used as a highly accurate voltage source for calibrating purposes. The positive electrode is mercury, the negative electrode is cadmium, and the electrolyte is a saturated cadmium sulphate solution.

wet cell A cell in which the electrolyte is in liquid form and free to flow and move.

wet electrolytic capacitor An electrolytic capacitor employing a liquid electrolyte.

Wheatstone automatic telegraphy That form of Morse telegraphy in which telegraph signals are transmitted mechanically from a perforated tape and recorded automatically in dots and dashes on a tape.

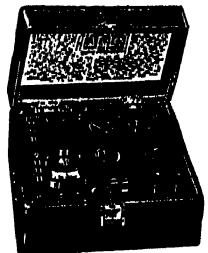

Wheatstone bridge An instrument for measuring resistance.

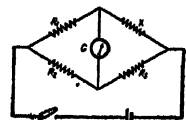

Wheatstone bridge and its basic circuit.

WHEEL STATIC

wheel static Interference encountered in auto-radio installations due to friction between the tires and the street.



Wheel static collector.

white The signal produced at any point in a facsimile system by the scanning of a selected area of subject copy having minimum density.

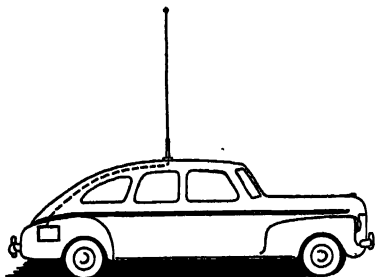

Whip antenna.

white light Any radiation producing the same color sensation as average noon sunlight.

white-to-black amplitude range 1. In a facsimile system employing positive amplitude modulation, the ratio of signal voltage (or current) for picture white to the signal voltage (or current) for picture black at any point in the system. 2. In a facsimile system employing negative amplitude modulation, the ratio of the signal voltage (or current) for picture black to the signal voltage (or current) for picture white. This ratio is often expressed in decibels.

white-to-black frequency swing In a facsimile system employing frequency modulation, the numerical difference between the signal frequencies corresponding to picture white and picture black at any point in the system.

whr Abbreviation for watt-hour.

wide-angle lens Any optical lens having an unusually large angular field. In general, a wide-angle lens has an angular field greater than about 80 degrees, as contrasted with ordinary lens fields of about 45 degrees.

width control The control that adjusts the width of the pattern on the screen of a cathode-ray tube in a television receiver or oscilloscope.

Wiedemann effect A twisting action in a ferromagnetic wire or rod placed in a magnetic field (torsional magnetostriction), and the reverse action which is the same as the Wertheim effect.

Wien bridge A type of capacitance bridge circuit developed by M. Wien for measuring dielectric losses.

Wien displacement law An expression representing the spectral radiant intensity of a blackbody as a function of the wavelength and the temperature.

Wilson chamber An enclosure containing air supersaturated with water vapor by sudden expansion, in which rapidly moving particles like alpha or beta rays produce ionization tracks by condensation of vapor on the ions produced by the rays. These tracks may be observed or photographed through a suitable window. A form of cloud chamber

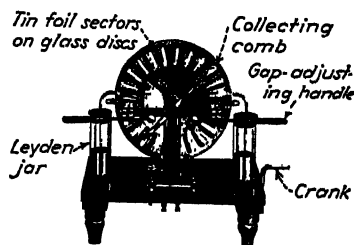

Wimshurst static machine, used for lecture demonstrations on electrostatic phenomena. It can produce a three-inch spark.

Wimshurst machine The commonest type of static machine or electrostatic generator, consisting of two glass disks rotating in opposite directions and having sectors of tin foil so arranged with respect to a connecting rod and collecting combs that static electricity is produced for charging Leyden jars or discharging across a gap.

wind charger A wind-driven direct-current generator used for charging batteries, such as for charging 32-volt farm lighting-plant batteries.

wind-driven generator A generator that derives its power from wind acting on its own propeller or from the air stream when used on aircraft.

winding One or more turns of wire forming a continuous coil for a transformer, rotating machine, or other device.

wire A slender rod or filament of drawn metal. If covered with insulation, it is properly called an insulated wire, but the term wire is often used in such a way that inclusion of its insulation is understood.



Wing nut.

wire broadcasting A broadcasting service in which programs are supplied to subscribers over permanent wire circuits either by audio-frequency currents or by modulated carrier-frequency currents.

wire communication The transmission of writing, signs, signals, pictures, and sounds of all kinds by aid of wire, cable, or other like connection between the points of origin and reception of such transmission.

wired radio The art of communication by means of modulated carrier currents guided intentionally by conductors instead of traveling through space as radio waves. Telephone wires are sometimes used for this purpose, as in the British system of rediffusion.

wire gage A system of numerical designations of wire sizes, starting with low numbers for the largest sizes. The American-wire gage, abbreviated AWG (formerly the Brown and Sharpe gage, abbreviated B & S gage) is in common use in this country and starts with 0000 as the largest size, going to 000; 00, 0, 1, 2, and up to 40 and beyond for the smallest sizes.

wire grating An arrangement of wires set into a wave guide to pass one or more desired waves while obstructing all other waves. Even a single wire along a diameter of a circular guide may serve this purpose. In conformal wire gratings, the wires are not parallel but are bent to conform to the lines of

electric force characteristic of the wave that is to be reflected or obstructed. Examples of this are radial gratings and circular gratings.

wireless British name for radio. Used in this country chiefly when the word radio might be misinterpreted, as in the term wireless record player.

wireless device Any apparatus that generates a radio-frequency electromagnetic field functionally utilized to operate associated apparatus not physically connected thereto and at a distance in feet no greater than 157,000 divided by the frequency in kilocycles. The apparatus must be operated with the minimum power possible to accomplish the desired purpose, and its total electromagnetic field produced at the maximum operating distance cannot legally exceed 15 microvolts per meter.

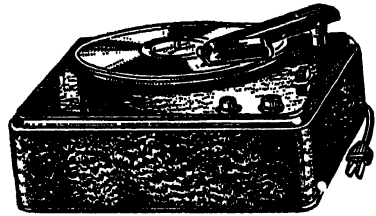

Wireless record player.

wireless record player An electric phonograph connected to modulate a radio-frequency oscillator that feeds a small built-in antenna, used to broadcast a phonograph recording across a room or into another room of a home for reception and reproduction by a radio receiver that is tuned to the frequency at which the oscillator is operating.

wirephoto 1. Transmission of photographs or other single images over a telegraph system by scanning the picture into elemental areas in orderly sequence, converting each area into a proportional electric signal, transmitting the signals in sequence, and reassembling them in correct order at the receiver. Also called *facsimile*, *phototelegraphy*, *telephoto*, etc. 2. A facsimile photograph so transmitted.

wire telephony The transmission of voice-frequency waves over wires either

WIRE-WOUND RESISTOR

directly as in voice-frequency telephony or as the modulating wave in carrier telephony.

wire-wound resistor A resistor employing as the resistance element a length of high-resistance wire or ribbon, usually Nichrome, wound on an insulating form.

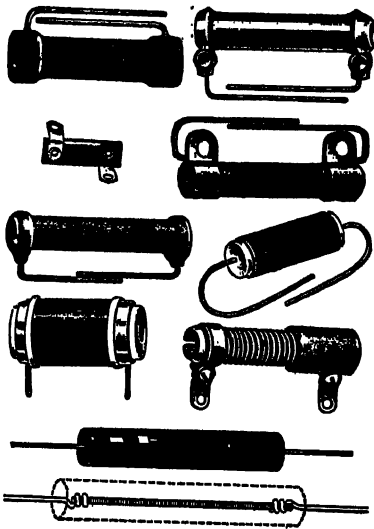
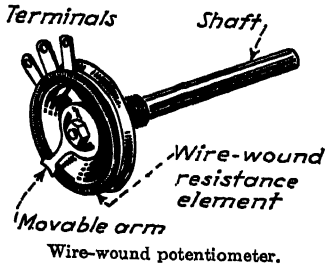

Wire-wound resistors.

wobbulator In one form, a motor-driven variable capacitor used to vary the output frequency of a signal generator periodically between two limits for certain types of tests of radio equipment, such as for frequency-response tests.

Wollaston wire Extremely fine wire made by coating fine platinum wire with silver, drawing it down further, then dissolving off the silver.

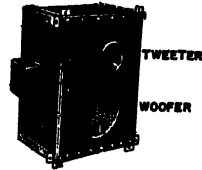

Woofers-tweeter combination.

woofer A large loudspeaker designed to reproduce low audio frequencies at relatively high power levels. Usually used in combination with a high-frequency loudspeaker called a *tweeter*.

work function A general term applied to the energy required to transfer electrons or other particles from the interior of one medium across a boundary into an adjacent medium. The photoelectric work function applies to the transfer of electrons from a metal to a vacuum under the action of light, while the thermionic work function covers the same transfer under the influence of heat.

working voltage Voltage rating. In an electrolytic capacitor, it is the highest voltage that can be applied continuously with safety against failure.

wound-rotor induction motor An induction motor in which the secondary circuit, generally on the rotating armature, consists of a winding or coils whose terminals are short-circuited through brushes or other suitable means.

wow Term often used to denote a change in pitch observable during reproduction of a recording, due to a low-frequency variation in the speed of either the recording or reproducing turntable.

wpc Abbreviation for watts per candle.

Written filter A gelatin or glass filter designed to have specific light-transmission characteristics.

wrinkle finish A lacquer or varnish finish that may be applied with a brush or spray and that dries with an attractive wrinkled surface. Often used on panels and cabinets of radio and other electronic equipment.

writing telegraph system A system of telegraphy in which the receiving equipment writes the message automatically in characters resembling handwriting.

WWV The call letters of a radio station maintained by the National Bureau of Standards for the purpose of dis-

seminating standard frequencies. It broadcasts continuously day and night on 5, 10, and 15 megacycles, and broadcasts from 7:00 P.M. to 9:00 A.M. EWT on 2.5 megacycles. In addition to these four standard carrier frequencies, it disseminates standard audio frequencies of 440 and 4,000 cycles and a standard time pulse.

X

- X** Roman numeral for 10.
- X** Letter symbol used in equations to designate reactance in ohms.
- XC** Letter symbol used to denote capacitive reactance in ohms.
- XL** Letter symbol used to denote inductive reactance in ohms.
- X axis** A reference axis in a quartz crystal.
- X cut** A cut made in such a manner that the X axis of the quartz crystal is perpendicular to the faces of the resulting slab. Sometimes called *Curie cut*.
- X particle** A particle having the same unit negative charge as an electron but a mass intermediate between that of the electron and the proton. Produced by cosmic radiation impinging on gas molecules, or actually forming a part of cosmic rays. Also called *barytron, dynatron, heavy electron, mesotron, penetron*, etc.
- X radiation** X-ray radiation.

X ray 1. A penetrating electromagnetic radiation similar to light but having much shorter wavelengths (from about 10^{-7} to 10^{-10} centimeter). Usually generated by accelerating electrons to high velocity and suddenly stopping them by collision with a metal target. The resulting bombardment of the atoms in the target causes the atoms to lose energy, and this energy is radiated as X rays of definite wavelength. Properties of X rays include ionization of a gas through which they pass, penetration of all solids in varying degrees, production of secondary X rays when stopped by material bodies, and action on fluorescent screens and photographic film. First discovered by Wilhelm Konrad Roentgen, German physicist, in 1895; later called roentgen rays after their discoverer (especially

by medical writers). 2. A photograph obtained by the use of X rays. 3. To examine, treat, or photograph with X rays.

X-ray apparatus An X-ray tube and its accompanying accessories, including the X-ray machine.

X-ray crystallography The study of the arrangement of atoms in a crystal by the use of X rays.

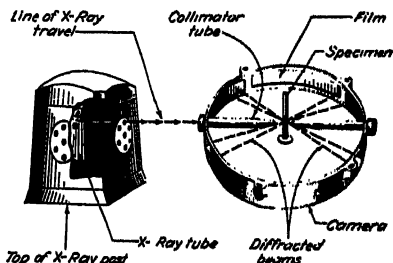

Operating principle of an X-ray diffraction camera.

X-ray diffraction camera An apparatus for directing a beam of X rays into a sample of an unknown material and allowing the resulting diffracted rays to act on a strip of film. The crystalline structure of each substance has its own unique diffraction effect on an X-ray beam, and consequently the X-ray diffraction patterns provide valuable practical information for rapidly identifying, comparing, and analyzing raw materials, chemical samples, finishes, etc.

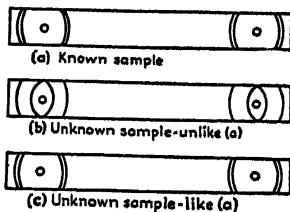

X-ray diffraction patterns, showing how known sample films are used to identify unknown materials.

X-ray diffraction pattern The pattern produced on film exposed in an X-ray diffraction camera, consisting of portions of circles having various spacings depending upon the material being examined.

X-ray goniometer The instrument used to determine accurately the position of the electrical axes of a quartz crystal. The X rays are reflected from the atomic planes of the crystal.

X-ray machine The assembly of electrical equipment required to activate an X-ray tube and control its operation.

X-ray photograph A picture produced on a radiation-sensitive surface by X rays, radium emanations, or other radiation than light, showing the non-uniform density of the structure through which the rays pass. Called *radiograph* sometimes, and called a *roentgenogram* by some medical authorities.

X-ray spectrograph An apparatus for recording photographically X rays reflected by crystals, to determine their wavelengths.

X-ray spectrometer 1. An instrument for producing an X-ray spectrum and measuring the wavelengths of its components. 2. A type of spectrometer used to measure the angles of diffraction of X rays produced by reflection from the surface of a crystal.

X-ray spectrum The orderly arrangement of a beam of X rays according to wavelength.

X-ray therapy Medical treatment by controlled application of X rays.

X-ray tube A high-vacuum high-voltage hot-cathode two-electrode tube de-



Beryllium-window X-ray tube.



Diagnostic X-ray tube used in modern medical X-ray units.

signed to produce X rays. Streams of electrons emitted from the cathode are directed on a target, usually of tungsten, producing X rays by bombardment.

X-ray vacuum A gas pressure below 0.01 millimeter, so named because pressures this low are required for the production of X rays.

Xu Abbreviation for X unit, a wavelength designation applied to X rays.

X unit A unit of wavelength equal to 0.001 angstrom unit, or 10^{-11} centimeter, used for specifying wavelengths of X rays and other highly penetrating radiations.

X wave One of the two components into which a radio wave is divided in the ionosphere by the magnetic field of the earth. Sometimes called the *extraordinary wave*. The other component is the ordinary wave, or *O wave*.

X-Y recorder A recorder that traces on a chart the relation of two variables, neither of which is time. Sometimes the chart is moved in proportion to time and one of the variables is so controlled that it increases in proportion to time. In a multiple X-Y recorder employing electronic circuits, frequency deviation and activity are plotted against temperature for quartz crystals.

Y

Y Letter symbol used to denote admittance in ohms.

Yagi antenna A particular form of end-fire antenna array having maximum radiation in the direction of the array line.

Y axis A line perpendicular to two opposite parallel faces of a quartz crystal.

Y connection A network of three resistors or impedances connected together in the form of a star or Y.

Y cut A quartz crystal cut such that the Y axis is perpendicular to the faces of resulting slab.

yd Abbreviation for yard.

yoke 1. A piece of ferromagnetic material, without windings, that permanently connects two or more magnet cores. 2. A coil assembly used to produce electromagnetic deflection of the electron beam in a cathode-ray television tube. It surrounds the neck of the tube.

Young's interference experiment An experiment performed by Thomas Young in 1801, which established the wave nature of light by demonstrating the interference of light from two sources.

Young's modulus The ratio of the increase in longitudinal force or tension applied to an object, per unit cross-section, to the resulting change in length per unit length.

Z

- Z** Letter symbol used to represent impedance in ohms.
- Z axis** The optical axis of a quartz crystal. It is perpendicular to both the *X* and *Y* axes.
- Zeeman effect** The increase in the number of spectrum lines produced by a light source when in a strong magnetic field.
- zeppelin antenna** An antenna that is some multiple of a half wavelength long and is fed at one end by one lead of a two-wire transmission line that is also some multiple of a half wavelength long.
- zero adjuster** A device for bringing the pointer of an electric instrument or meter to zero when the electric quantity is zero.
- zero beat** The condition in which a given receiving circuit is oscillating at the exact frequency of incoming radio waves, so that no beat tone is produced or heard.
- zero-beat reception** A system of radio reception for suppressed-carrier systems of radio telephony, in which the receiver generates a voltage having the original carrier frequency and combines it with the incoming signal. Sometimes called *homodyne reception*.
- zero bias** A condition in which the control grid and cathode of a vacuum tube are at the same potential.
- zero-field emission** Thermionic emission from a hot conductor which is surrounded by a region of uniform electric potential.
- zerograph** An early form of start-stop printing telegraph apparatus.
- zero level** The reference level used for comparing sound or signal intensities. In audio-frequency work, a power of 0.006 watt is generally used as zero level. In sound, the threshold of hearing is generally assumed as the zero level.
- zero method** Any method of measurement in which the reading is taken after the circuit has been balanced to bring the pointer of the indicating instrument to zero, as in a Wheatstone bridge or in a laboratory balance for weighing purposes. Also called *balance method* or *null method*.
- zero potential** An expression usually applied to the potential of the earth, as a convenient reference for comparison.
- zigzag reflections** High-order multiple reflections from a layer of the ionosphere. They occur in waves that travel by multihop ionospheric reflection and finally turn back toward their starting point by repeated reflections from a slightly curved or sloping portion of an ionized layer. They may have abnormal intensity.
- zinc** A bluish-white metallic element used in its pure form in dry cells, widely used in galvanizing of iron, and used in alloys such as brass.
- Zn** Chemical symbol for zinc.
- zone of silence** A local region in which the signals of a given radio station cannot be satisfactorily heard.
- zone police station** A station used by police departments for radiotelegraph communication with stations within the zone, with mobile police units equipped for radiotelegraph reception, and with stations in adjacent zones.